

# GRAVELLY

## USER MANUAL

### INDEX

|                             |         |
|-----------------------------|---------|
| Accessories .....           | 24      |
| Adjustments, Tractor .....  | 4       |
| Air Cleaner .....           | 1       |
| Chain Guard .....           | 10      |
| Chain Saw .....             | 10      |
| Circular Saw .....          | 11      |
| Dual Wheels .....           | 14      |
| ENGINE CARE .....           | 1 & 2   |
| Extension Axles .....       | 14      |
| Gang Mower .....            | 7       |
| Geared Wheels .....         | 15 & 16 |
| Leaf Mulcher .....          | 10      |
| LUBRICATION, TRACTOR .....  | 1       |
| Oil Pressure Gauge .....    | 24      |
| Power Barrow .....          | 23      |
| Power Brush .....           | 21      |
| Power Spreader .....        | 21      |
| Power Take-Off .....        | 22      |
| Rear Hitch .....            | 22 & 23 |
| Reel Mower .....            | 6       |
| Riding Sulky .....          | 12 & 22 |
| Roller .....                | 12      |
| Rotary Cultivator .....     | 16      |
| Rotary Knife Mower .....    | 9       |
| Rotary Plow .....           | 14-16   |
| Sickle Grinder .....        | 24      |
| Sickle Mower .....          | 12-14   |
| Snowblower .....            | 19 & 20 |
| Snow Plow, Blade Type ..... | 20      |
| Steering Sulky .....        | 12 & 22 |
| Tire Chains .....           | 24      |
| Toolholder Cultivator ..... | 18 & 19 |
| TRACTOR OPERATION .....     | 2-6     |
| Trouble Shooting .....      | 5 & 6   |

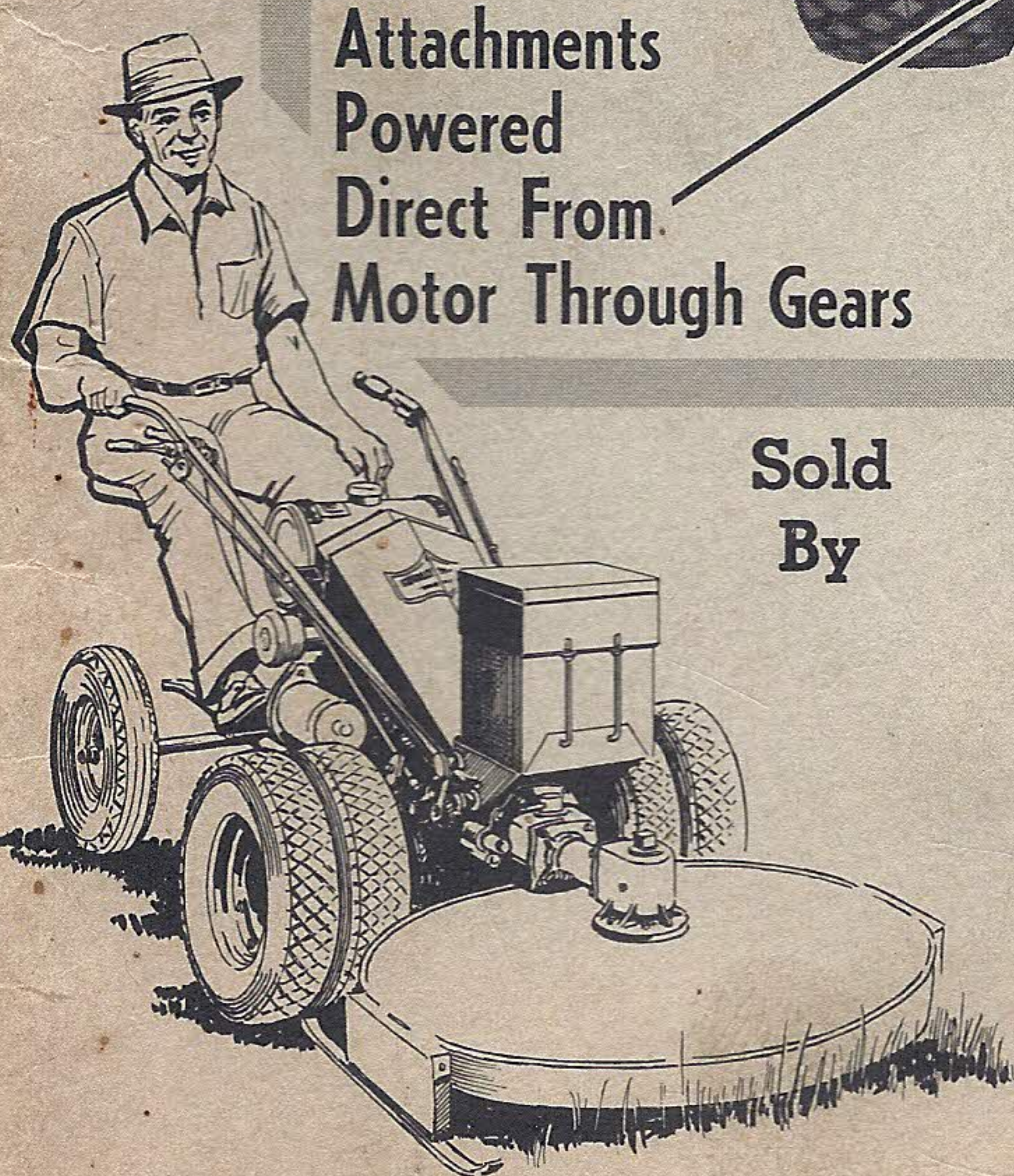
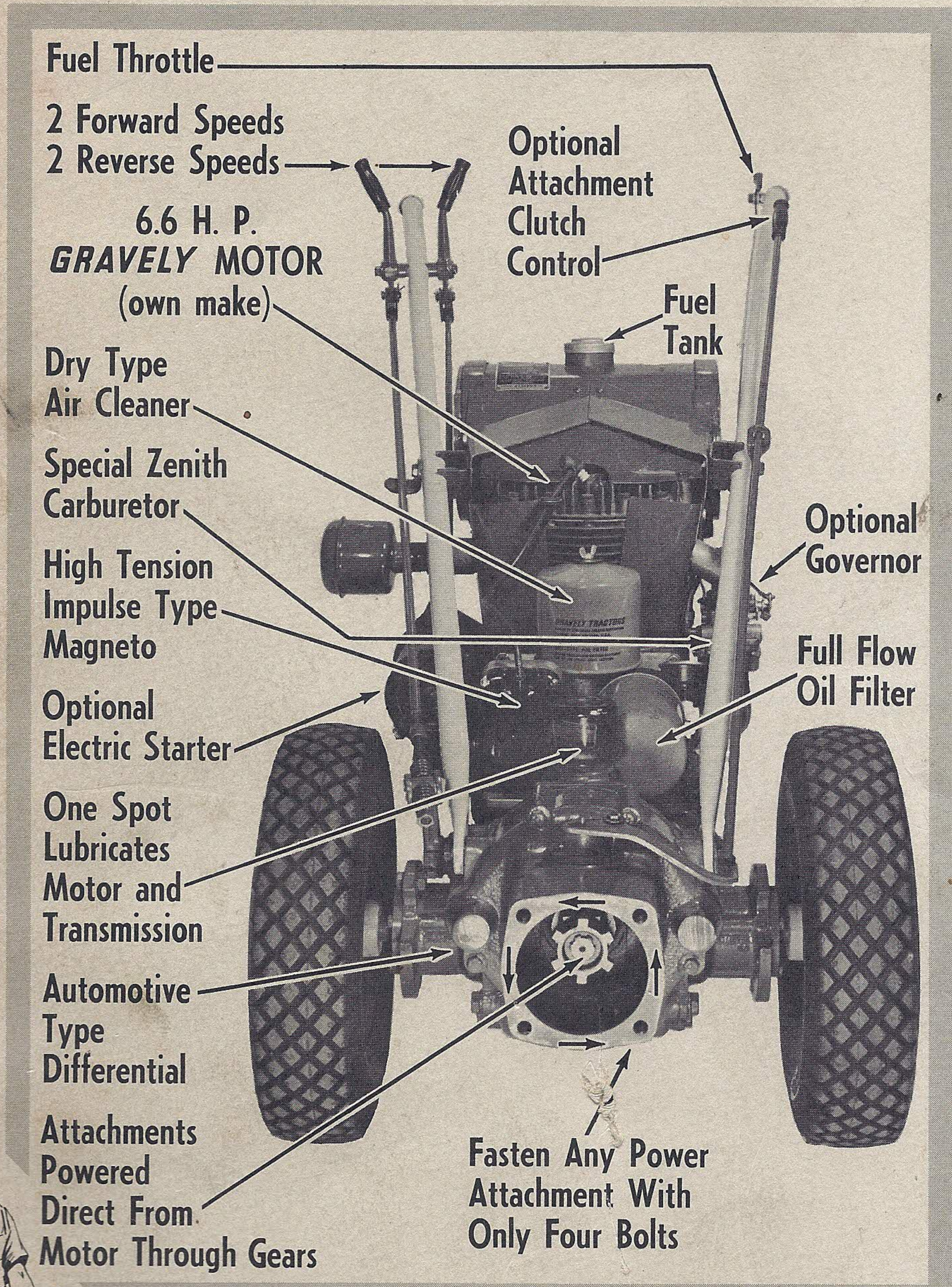

Sold  
By

**THE GRAVELLY TRACTOR**

**LUBRICATION**

**ENGINE - CHASSIS - CAPACITY 5 U.S. PINTS**  
USE ONLY HIGH GRADE LUBRICANTS SUCH AS -  
ABOVE 32°F. **MOBIL OIL A** (SAE 30)  
BELOW 32°F. **MOBIL OIL ARCTIC** (SAE 20W)  
WITH MACHINE LEVEL - FILL TO OIL LEVEL PLUG  
LOCATED ON SIDE OF CHASSIS

**FUEL TANK CAPACITY - 2 U.S. GALLONS**  
**FUEL - USE GOOD GASOLINE SUCH AS -**  
**MOBIL GAS (REGULAR GRADE)**

**ATTACHMENTS - USE GEAR OILS SUCH AS -**  
SUMMER - **MOBILUBE GX 140** (SAE 140)  
WINTER - **MOBILUBE GX 90** (SAE 90)

**READ INSTRUCTION MANUAL CAREFULLY**

|                             |                              |
|-----------------------------|------------------------------|
| <b>MODEL NUMBER</b>         | <b>TRACTOR SERIAL NUMBER</b> |
| L                           | [REDACTED]                   |
| <b>MANUFACTURING NUMBER</b> |                              |
| E- [REDACTED]               |                              |

**MANUFACTURED BY**  
**GRAVELLY TRACTORS**  
DIVISION OF STUDEBAKER-PACKARD CORPORATION  
DUNBAR, WEST VIRGINIA, U.S.A.

PL-1 R-0



# THANK YOU

For your investment in Gravelly Equipment. It is an investment, for the Gravelly will save you work and worry for many years.

You will gain still greater satisfaction from your powerful Gravelly if you add the tools you need for your other jobs. From time to time we suggest you consult our catalog, or this instruction book. You will find many attachments that will eliminate upkeep and garden drudgery.

Your Gravelly representative will be glad to demonstrate any Gravelly attachment to you any time. There is no obligation involved.

If you require parts and service, our representatives have the facilities to handle your problems. They are specialists in Gravelly Service—have the special tools and training necessary to give you the best possible job at the most economical price.

We sincerely hope you will enjoy the use of your Gravelly Equipment for many pleasant and profitable years.

Yours sincerely,

## **GRAVELLY TRACTORS**

### **Guarantee**

The Gravelly Tractor and Attachments are guaranteed to be free from defective material and workmanship for a period of ninety (90) days from the date of purchase. All defective parts will be replaced without charge, provided such parts are returned to the seller, transportation charges prepaid, and in the Seller's opinion, after inspection, are defective, and have not been damaged through neglect, accident or misuse.

#### **IMPORTANT**

This is your guarantee, but it is not valid or effective unless within seven days after delivery of your equipment you complete the "Guarantee Registration Card" and mail it to

## **GRAVELLY TRACTORS**

DIVISION OF STUDEBAKER PACKARD CORPORATION

Dunbar, West Virginia



# THE *GRAVELY* TRACTOR . . .

The Gravelly Tractor is a 6.6 Horsepower, air-cooled, 4-cycle, one-cylinder Tractor. It is designed and built for the tough jobs . . . powers 30 different tools and attachments.

Your Gravelly equipment will serve you long and faithfully—if you take reasonable care. It is to YOUR advantage to spend a few moments now, reading these instructions and operating hints. You will be rewarded by greater satisfaction, fewer repair bills, easier operation.

## MANUFACTURER

The Gravelly Tractor and its attachments are manufactured by Gravelly Tractors, Division of Studebaker-Packard Corporation, Dunbar, W. Va. A subsidiary factory is located at Albany, Georgia.

More than 50 Sales and Service Stations distribute the Gravelly Tractor and its attachments. Working with them is an organization of independent Dealers. Each is equipped to give prompt and efficient service, with parts in stock, and mechanics trained in factory method service, if required.

## GUARANTEE

The Gravelly Guarantee is shown on the opposite page. To qualify for this guarantee, it is necessary for you to return the card bound into this booklet to the factory at Dunbar, W. Va. A postage-free envelope is furnished. Fill out and mail immediately, for your own protection.

## FUEL

Use a good **regular** gasoline. We recommend Mobilgas (A Socony-Mobil Product). Tank capacity is about 1¾ gallons. **DO NOT USE HIGH-TEST GASOLINE.**

## LUBRICATION

### CHECKING OIL LEVEL

Your tractor is usually filled with fuel and the proper amount of oil added when it is delivered. However, you should routinely check the oil before starting the engine.

Be sure the Tractor is setting level.

Oil is checked by removing the Oil Level Plug (In some models, a Bronze Try Cock Valve). See Plate 2, Number 2. If oil runs out, the Tractor has sufficient. If not, add oil (See lubrication table). Remove the Oil Filler Cap (Plate 2, Number 6). A small funnel is helpful. Add oil UNTIL IT **BEGINS TO RUN OUT** Oil Level Hole. Stop. Too much oil is as bad as not enough. Replace Oil Level Plug and Oil Filler Cap.

### CAPACITY AND RECOMMENDED OILS

The Capacity of the Chassis is **FIVE PINTS (5 Pints)** of **motor oil**. Filling the Chassis lubricates both Engine and Transmission. **WARNING:** Do NOT use Transmission Greases or Oils. Only Motor Oil.

We recommend:

**SUMMER:** Mobiloil A (SAE 30) or Mobiloil Special (10W-30)

**WINTER:** Temperature range from 32° F. and below,  
Mobiloil Arctic (SAE 20) or  
Mobiloil Special (SAE 10W-30)

### BREAKING-IN LUBRICATION — OIL CHANGES

The break-in period is critical for any engine. We recommend that for the first 40 hours of work the Gravelly Tractor be used for jobs that do not require the full power of the engine for extended periods of time. Short periods that require full power will not harm the engine. Do not "race" the engine wide-open when not under load. Let the engine "warm up" for about two minutes at a fast idle before starting to work.

Change the oil after the first 20 hours of work, completely draining out the old oil and refilling with new. Change again at the end of the second 20 hours of work. After that, a good practice is to change oil every 40 hours of work if the equipment is operated under dusty and dirty conditions, 60 hours if under normal mowing conditions.

**INDUSTRIAL USERS:** For extended operation, as in industrial mowing, we recommend an oil change every week (40 hours).

Oil Changes are probably the most important single item of care to insure long life of your Gravelly Equipment. Neg-

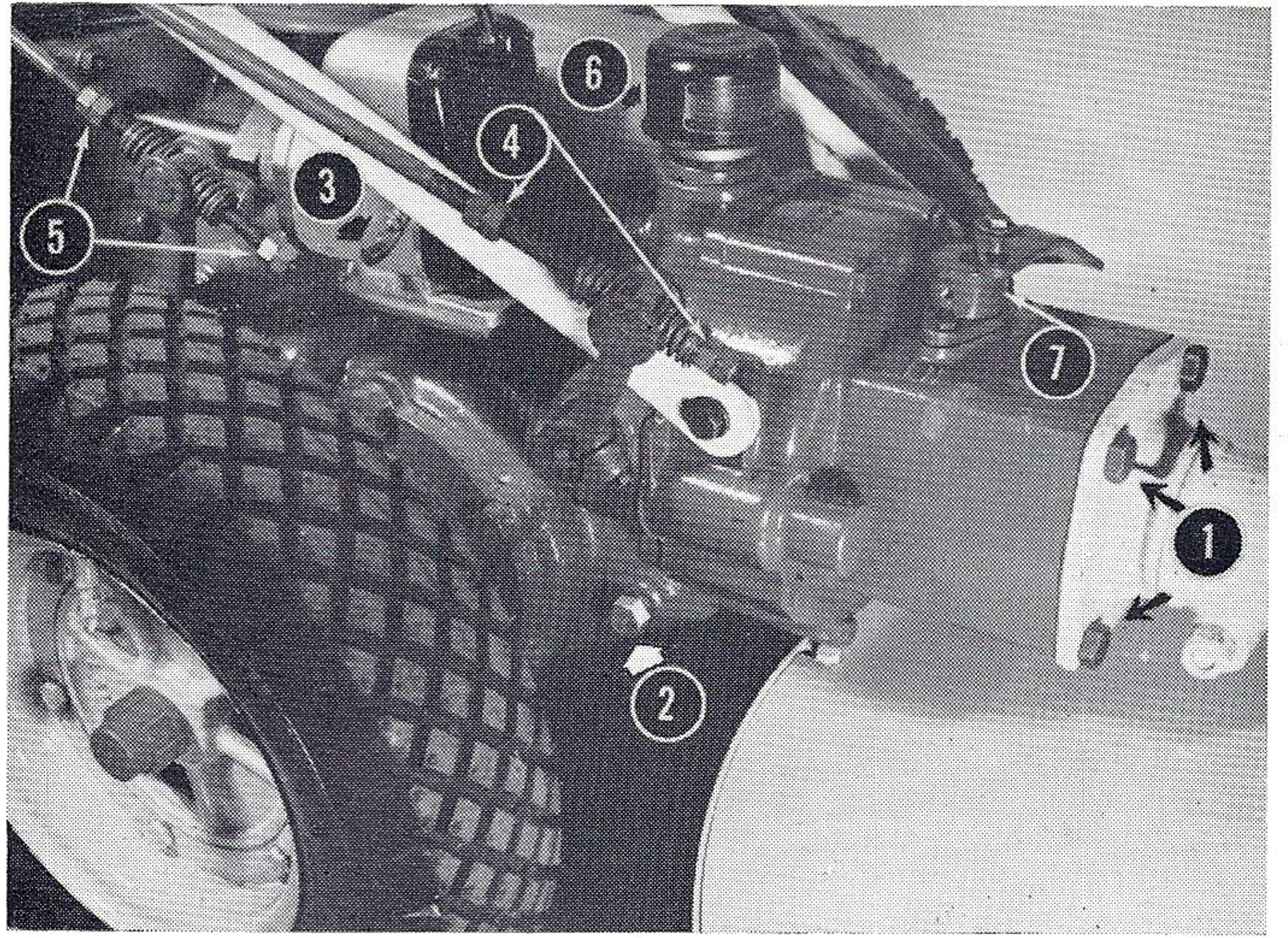

PLATE 2

- |                                       |  |
|---------------------------------------|--|
| 1. Attachment Bolts                   | 5. Clutch Adjusting Nuts (Forward & Reverse) |
| 2. Oil Level Plug                     | 6. Oil Filler Cap                            |
| 3. Magneto Stop Button                | 7. Attachment Clutch                         |
| 4. Clutch Adjusting Nuts (High & Low) |  |

lect of this essential procedure will surely result in excessive maintenance and unnecessary repair bills.

### OIL DRAIN PLUG

Tractors with **SERIAL** Numbers M 15476 and higher: The Oil Drain Plug is the **bottom bolt** of the Axle Housing, on the left side of the Tractor as you stand behind the handles.

Care should be taken any time the Axle Housing Bottom Bolt is removed and replaced to be sure the Nylon Plugged Drain Bolt is always reinserted in the Bottom Bolt Hole, and the special sealing washer is in place.

Tractors with **SERIAL** Numbers lower than M 15476, the Oil Drain Plug is located on the Bottom of the Chassis.

### OIL FILTER

Changing the Oil Filter often is most important for the life of the engine, and your satisfaction with Gravelly Equipment. Gravelly uses a replaceable Oil Filter. The Oil Filter should be changed every 150 hours (MAXIMUM) of use, or once a Season, whichever is sooner.

**CAUTION:** Do NOT change connections in any way.

### AIR CLEANER

Next to proper lubrication, the care of the Air Cleaner is most important. This is the protection of the engine against dust and abrasive particles of all kinds. Proper care will insure longer life for the engine, less maintenance cost.

Two types of Air Cleaner are used on the Gravelly Tractor. The Oil Bath Air Cleaner is quickly distinguished by its Black color. The Dry Type Air Cleaner is Orange, in the same location.

#### CARE OF DRY TYPE AIR CLEANER

The dry type air cleaner filters the intake air through a throw-away element. It should be inspected at intervals to determine when it needs changing. Plugging of the filter will starve the engine of air and will thus reduce its power output. This will also cause hard starting. The frequency of need to change the element will depend upon the amount of dirt and dust in the area of operation.

In handling of the element, care must be taken to not puncture or damage the element in any way. Its construction is such that it will remove dirt as small as 10 microns or 4/10,000 inches in diameter, thus any small hole will make it ineffective, and result in worn engine parts.

#### CARE OF OIL BATH AIR CLEANER

The Air Cleaner should be inspected **daily** during operation. Empty the Cleaner, clean out the bowl, and refill with Mobiloil A (SAE 30) or Mobiloil Special (10W-30) as required, according to directions on the Air Cleaner.



When using in very dusty and dirty conditions, we recommend this care every **four hours** of operation.

**INDUSTRIAL USERS:** For extended use, such as Gravelly Equipment receives in Industrial applications, we recommend that the Air Cleaner be **INSPECTED** every two hours, **CLEANED AND REFILLED WITH OIL** a minimum of every four hours of operation, oftener if inspection shows it is required.

**THE CARE OF THE AIR CLEANER IS SO IMPORTANT TO THE LIFE OF YOUR GRAVELY TRACTOR ENGINE THAT OUR GUARANTEE WILL NOT REPLACE PARTS THAT ARE WORN BECAUSE PROPER CARE OF THE AIR CLEANER HAS BEEN NEGLECTED.**

### OIL PRESSURE

Oil Pressure failure is a very rare occurrence, but a costly one when it happens. We recommend the purchase of an Oil Pressure Gauge from your Gravelly Dealer, and a quick glance at it whenever you start your tractor. If Oil pressure fails, **STOP THE TRACTOR IMMEDIATELY** and call your Dealer.

Unless you have the Oil Pressure Gauge, the only way to check Oil Pressure is to remove the Oil Filler Cap while the tractor is running, and observe to see if oil is flowing in a good, steady stream. **CAUTION:** Watch your face and eyes—as the oil will splash upward when the Filler Cap is removed.

### OPERATION

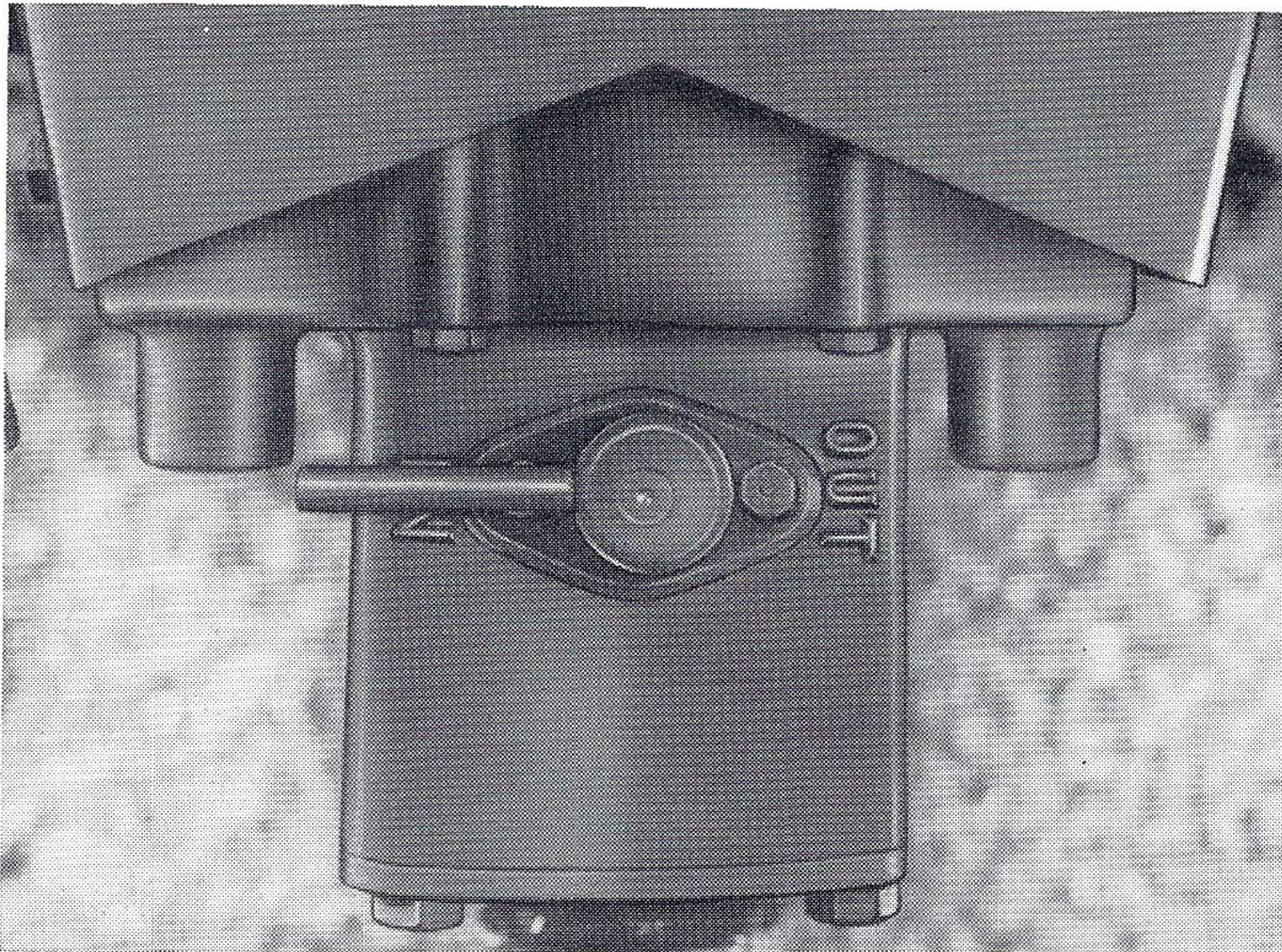

PLATE 8

### ATTACHMENT CLUTCH

The Attachment Clutch is actuated by a lever on the front of the Tractor (See Plate 8).

On the Advance Casting you will see the words **IN** and **OUT** embossed on the metal.

When the lever is over the **IN**, the attachment is in gear. **OUT**, the attachment is out of gear.

**HINT:** When putting **POWER ATTACHMENTS** in gear, have the High-Low Lever in Neutral. Then "slip" the clutch, using the reverse only until you hear or feel the engine "pull down" a little. You can then flip the attachment in gear without raking the Attachment Clutch Gear. This will save wear on the clutch.

**CAUTION:** When attaching or adjusting a **POWER ATTACHMENT**, always have the Attachment Clutch Lever in the **OUT** position, the Tractor Engine stopped.

### OPTIONAL ATTACHMENT CLUTCH CONTROL

An optional Attachment Clutch Control may be obtained for greater convenience. See illustration on page 24.

### CHANGING GEARS

The Gravelly Tractor gives you two forward and two reverse speeds. As you stand at the Handles of the Tractor:

**LEFT HAND** Lever is gear selector, for high and low speeds.

**RIGHT HAND** Lever is gear selector for forward and reverse.

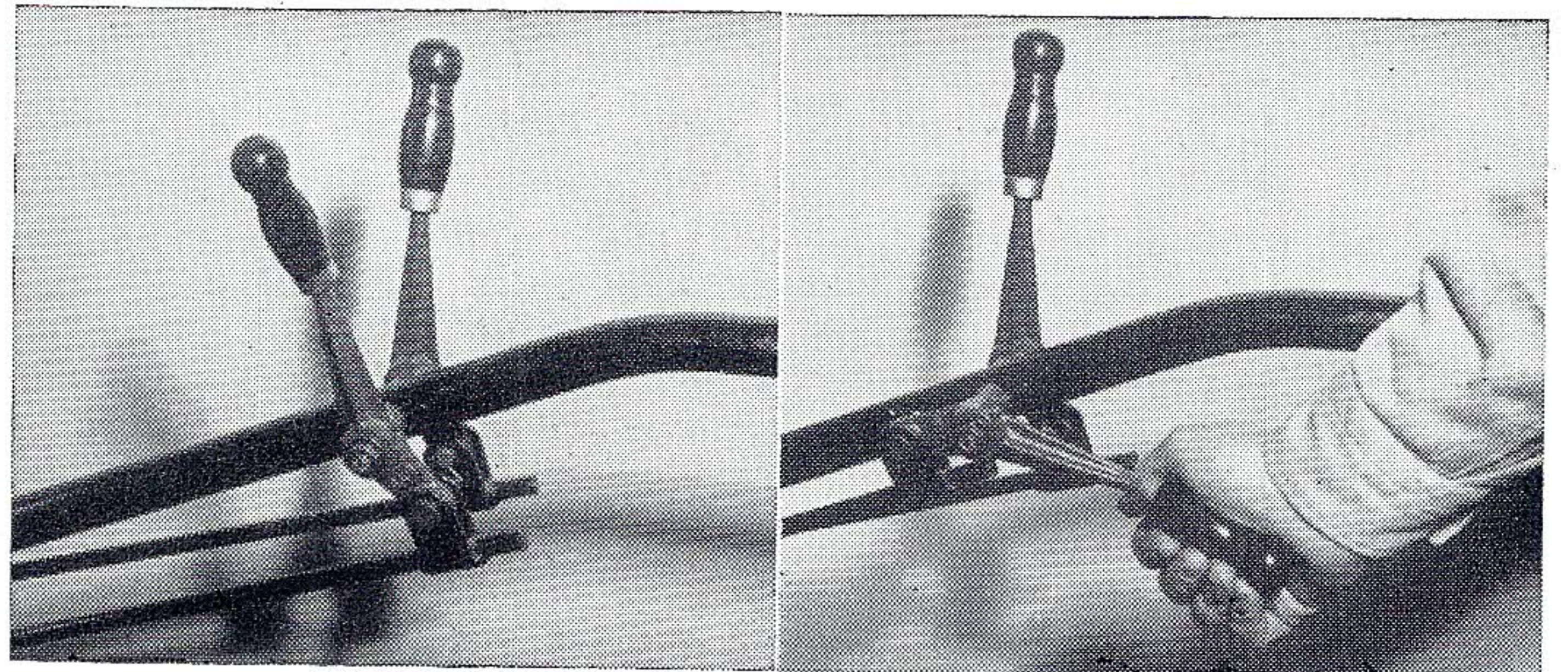

**NEUTRAL:** Both Handles in UP Position.

**HIGH:** Left hand lever back and down.

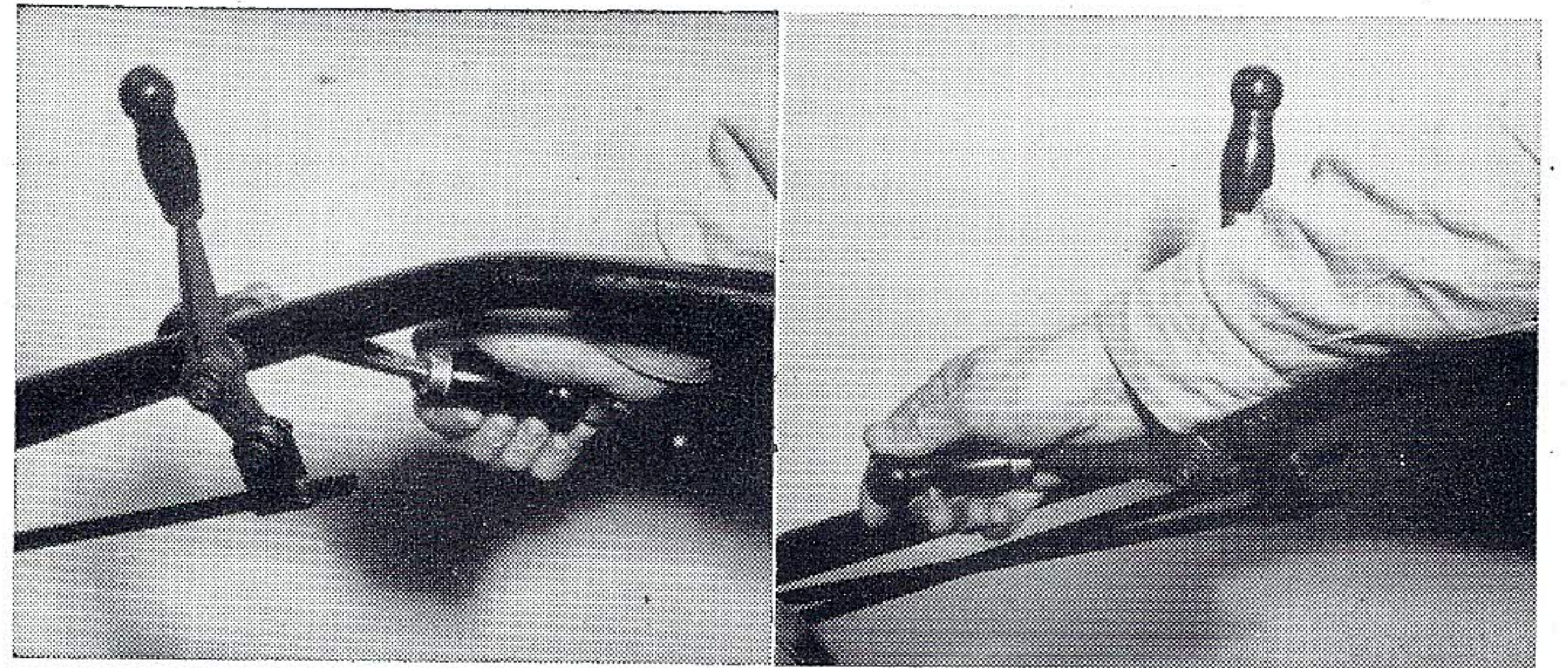

**FORWARD:** Right hand lever back and down.

**LOW:** Left hand lever forward and down.

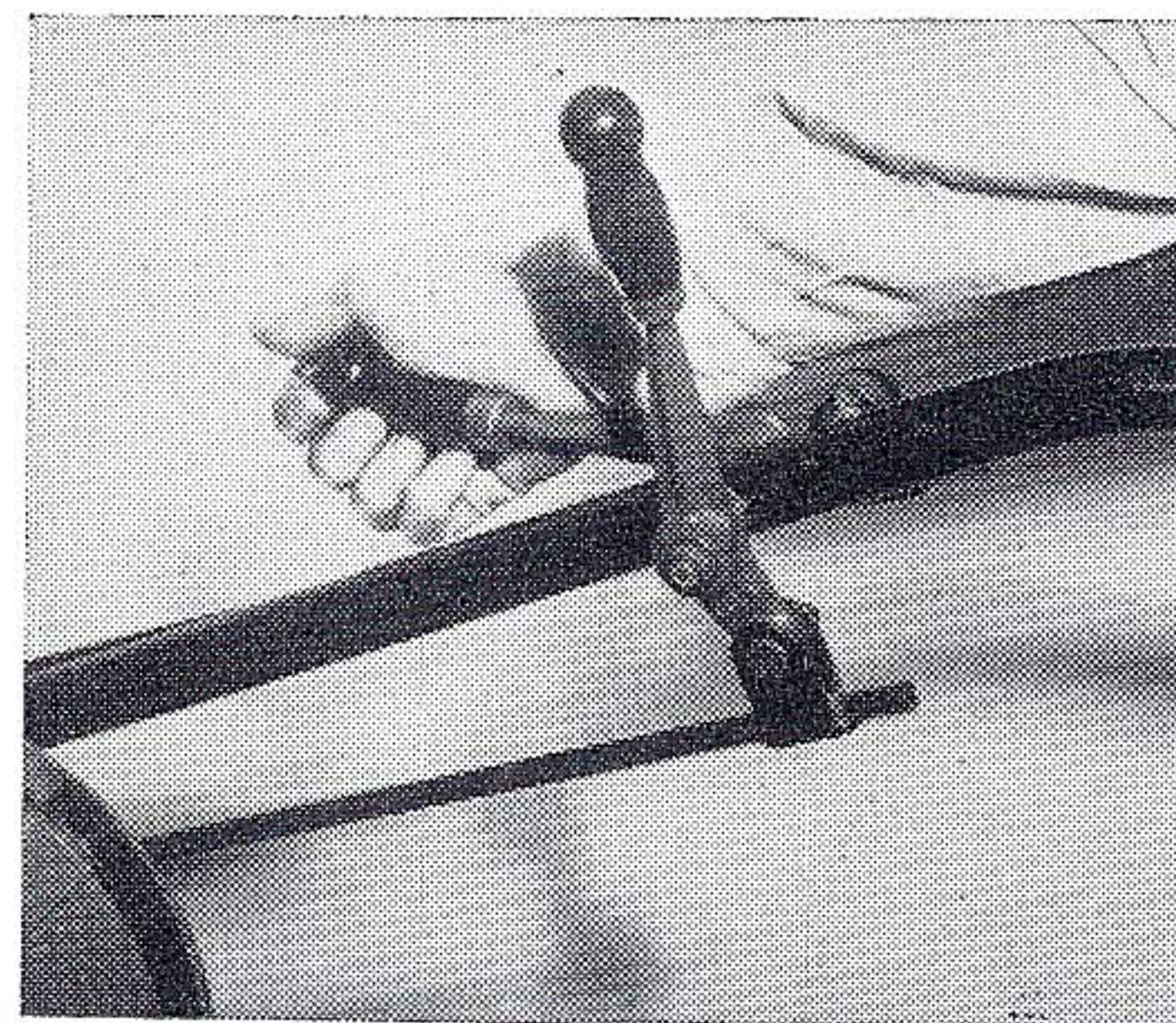

**REVERSE:** Right hand lever forward and down.

**CAUTION:** Always keep your hand on the Reverse lever when you are backing up. Then, if you slip, or get backed into a corner, you can throw the machine out of gear quickly.

You may change either lever without changing the other.

### SAFETY REVERSE

The Reverse Lever can be adjusted to give a "Safety" Reverse. This is done by adjusting the Clutch Adjustment Nuts that operate the Reverse Clutch so it is impossible to put the Clutch Lever into the lock-down position, and you must keep your hand on the lever. This will also allow the Reverse Lever to return to Neutral if you let go of the lever. (See: Clutch Adjustment)

### FUEL THROTTLE

The Gravelly uses a hand-feed Fuel Throttle. Depressing the Throttle Lever gives more Fuel; bringing it up, less.

### GOVERNOR

The Governor is optional. It will automatically feed the fuel to the engine according to the work-load. This saves wear on the equipment, and makes operation of the equipment much easier.

There are two types of Governor controls used on Gravelly Tractors. To operate—if yours is the "push-pull" type—simply pull the Governor Throttle out until the Attachment operates at the speed you desire. After this speed is obtained, the Equipment will operate at that speed no matter how much load is put on the machine, without further attention from you. To reduce speed, push Throttle in.

If you have the Lever type Governor control—push the Throttle Lever down with thumb of left hand, until the Attachment reaches your desired speed. Again the equipment will operate at that speed with no further attention from you. To reduce speed, simply move Lever up with thumb.



## ATTACHING TOOLS

All Power Attachments and all others, except a few tools which may be hitched on the rear of the Tractor, are attached by four bolts to the front of the Tractor. (See Plate 2, Number 1.)

The Attachment Clutch Lever must be in the OUT position when attaching any tool to the front of the Tractor. **Gravely Tractor Stand.** This portable, inexpensive stand allows you to quickly adjust height of Advance Casting, holds Tractor firmly for easy attachment of tools.

## PREPARING TO START THE TRACTOR

1. Gear Levers in Neutral Position.
2. Attachment Clutch Lever in OUT position
3. An Attachment, or the Attachment Boss Cover and Gasket (Part Numbers L-228 & L-229) must be in place on the front of the Tractor before starting the motor.
4. Be sure the Valve on the bottom of the Sediment Bowl under the Fuel Tank is in the OPEN position.
5. Open Throttle About Half-Way.
6. IF YOU HAVE A MAGNETO HANDLE STOP SWITCH, BE SURE IT IS SWITCHED TO "ON"!!

## STARTING THE TRACTOR

The Gravely is equipped with a strap starter. The small hole in the end of the leather Starting Strap slips over a pin in the pulley at the rear of the Tractor. Wind the strap **in the direction of the embossed arrow.** Put the Throttle down about halfway: (If you have a Governor, Throttle halfway OUT.) Give a strong, steady pull. Choke as needed.

See Plate 9 for the proper way to wind the strap.

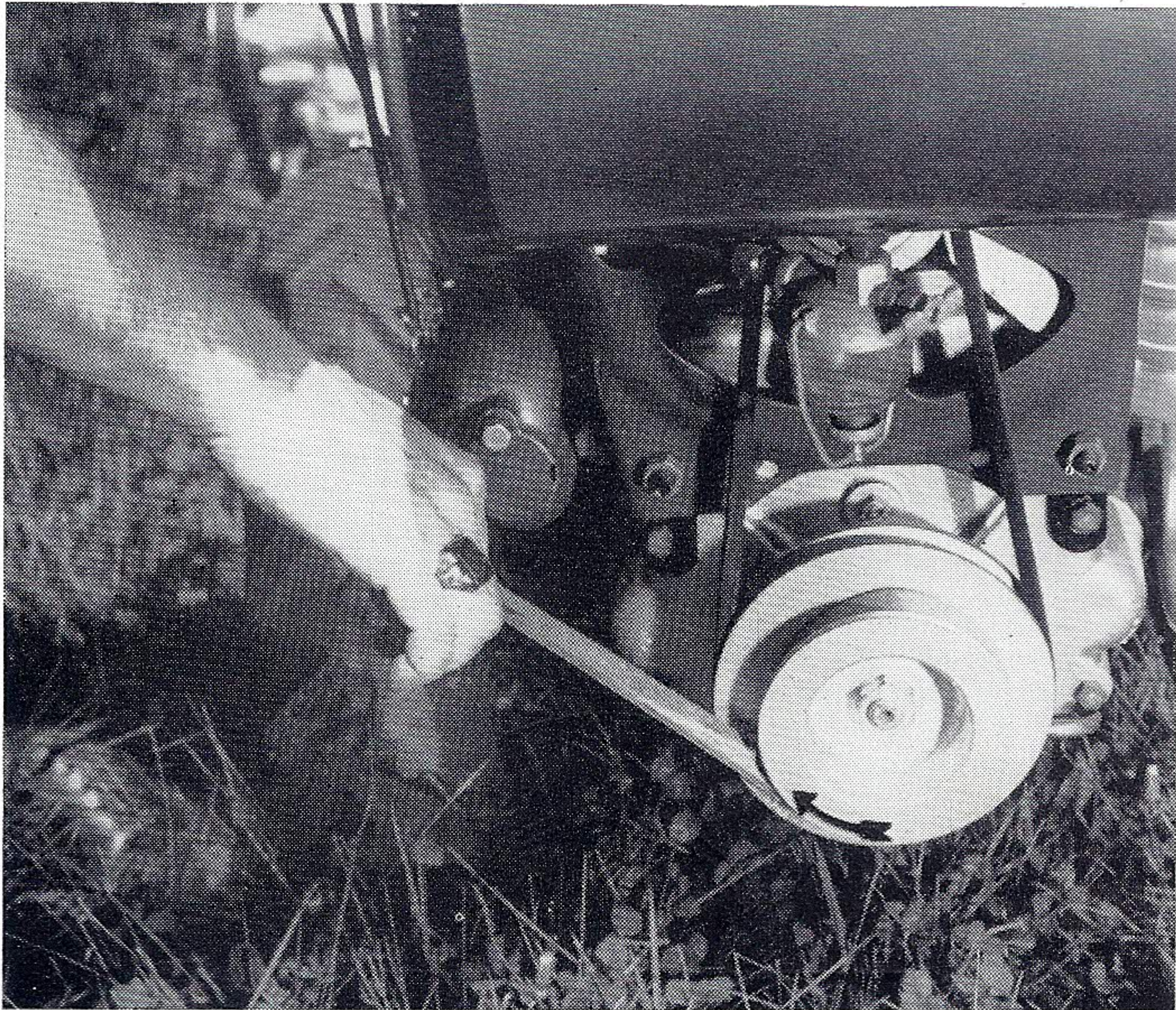

PLATE 9

## COLD WEATHER STARTING

### RECOMMENDED PROCEDURE

1. Store Gravely in a heated building. If not possible, pre-heat engine by any safe method. An Engine Heater, produced especially for the Gravely Tractor, is available at low cost. Inquire from your Dealer or the Factory. **DO NOT USE A BLOW-TORCH. DO NOT USE OPEN FLAME.** Be sure to check for gasoline leaks before attempting to pre-heat the engine.

2. **BE SURE PROPER WEIGHT OIL IS USED.** Mobil-oil Arctic or Mobiloil Special (SAE 10W-30) will give your engine proper lubrication protection, and are still fluid at low temperatures. Other oils of heavier weight will "stiffen" and contribute to hard starting.

3. Choke as required. Usual procedure is to open choke and leave open until engine starts, then close gradually as engine warms up.

4. If engine floods, rotate engine by hand with Choke closed and Throttle Open, then try again.

5. If you are starting with the Strap, spin engine hard and fast. The Gravely will start on the first pull in warm weather, but in cold weather, the temperature in the combustion chamber is so low often the engine will fire once, but does not have enough momentum to run through the firing cycle twice and then run on power. So pull **hard and fast.**

6. If engine does not start, take Spark Plug out and check: It should be an Autolite TT-10. If fouling or moisture is present, clean, reset points to .033; warm until all moisture is evaporated. Replace and try again.

7. Check to see if water, snow or ice has shorted out Magneto Shorting Button, or if the Spark Plug is contacting a bent or damaged hood through a worn cover. (If you have had a Dealer install the Magneto Handle Stop Button . . . Is the switch on? Is it shorted out? To check, remove wire from Magneto Connection to the Switch and try again.)

8. Check for ice in the Sediment Bowl and lines, or in or on Carburetor. Heating with a Heat Lamp at a reasonable distance (TAKE SAFETY PRECAUTIONS) will melt ice so formed, as will the use of ice-preventive additives in the gasoline, used according to manufacturer's directions.

9. Is the vent hole in the Gasoline Cap open? Sometimes ice or snow seals the hole, which gives a vapor lock.

10. If these suggestions fail, check the "Trouble-Shooting" section for mechanical problems and their remedies. Or, call your Gravely Service Man.

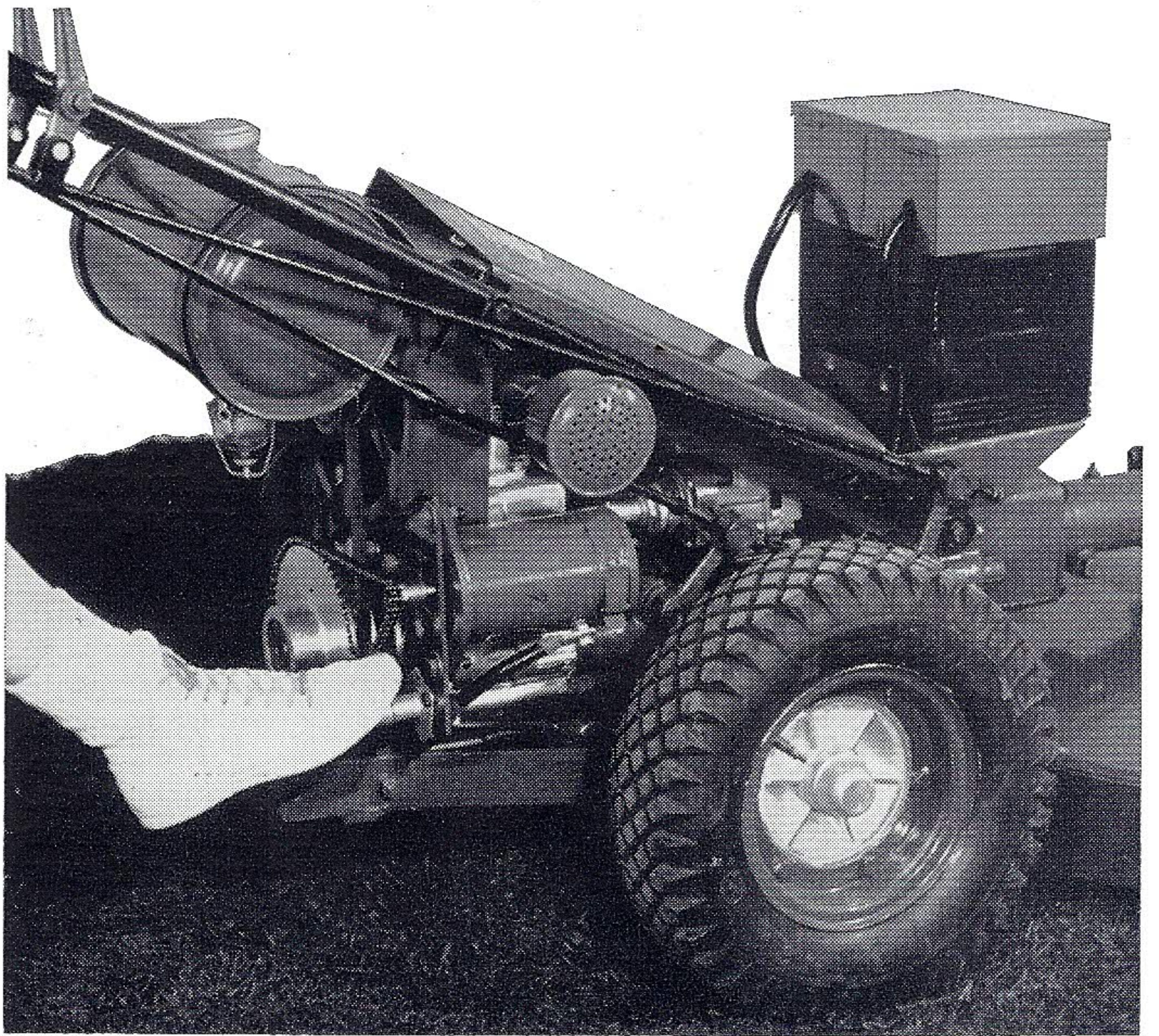

PLATE 10

## OPTIONAL ELECTRIC STARTER

Now you start your Tractor as easily as you start your car! Gravely Electric Self-Starter means push-button starting . . . new ease and convenience. Especially useful in cold-weather starting.

## ATTACHING

Installation Instructions are packed with Starter Kit. Uses any standard 6 Volt Automobile or Tractor Battery.

## STOPPING THE TRACTOR ENGINE

On the Magneto (Plate 2, Number 3) there is a small clip, or button. To stop the engine, depress this button and hold it depressed until the engine stops.

## HANDLE STOP SWITCH

Your Dealer can furnish an inexpensive Magneto Handle Stop Switch, attached to the handle, for more convenient stopping of the engine.

## TIRES

The recommended pressure for the Tractor tire is 20 pounds. Sulky tires take the same. Transportation Cart tire pressure should be 30 to 35 pounds.



Semi-Pneumatic Puncture-proof tires are available on special order.

## ADJUSTMENTS YOU SHOULD KNOW

### SPARK PLUGS

Spark Plug (Autolite TT-10) points should be cleaned and adjusted for clearance occasionally. The recommended gap is .033.

### VALVES

Valves can be set in the field if necessary. The clearance between Valve Stem and Valve Plunger is .012.

#### TRACTORS WITH MANUFACTURING NUMBER B-7619 AND BELOW:

To adjust Valves, rotate engine by hand until the end of compression stroke. (Both valves seated, piston top dead center.) Raise the Spring Sleeves. You will need two wrenches, a 9/16" open end, and a 1/2" open end. The 9/16" nut is the lock nut . . . hold it with your wrench and operate the 1/2" bolt with the other, adjusting until the clearance is correct. Lock in place with 9/16" nut.

Note: The clearance is .012 WHEN THE ENGINE IS COLD. DO NOT ADJUST VALVES WHEN ENGINE IS WARM OR HOT.

#### TRACTORS WITH MANUFACTURING NUMBER B-7620 AND ABOVE:

Remove Valve Cover Cap and use 7/16" open end wrench to adjust Tappet clearance. This is a self locking Tappet. Clearance is the same—.012 engine COLD.

### CLUTCHES

The Gravely uses a double-acting, cone-type Clutch. To take up for wear, tighten the nuts on the ends of the Clutch Rods. If adjustment is needed, your Clutch will "slip" even when locked in position. Unless the Clutch is slipping, let the adjustment alone. (See Plate 2 Numbers 4 and 5.)

The Gravely Clutch may have a tendency to "creep" a little occasionally, even when in neutral. This is of no consequence and does not mean that there is anything wrong with the Tractor or the Clutches.

### SAFETY REVERSE

Nuts (Plate 2, Number 5) adjust the Reverse Clutch. To adjust so the Reverse will automatically return to Neutral when the lever is released, Put Clutch Lever in Reverse, in the locked down position. You will see the Lock nut and Adjusting nut that operate the Clutch Actuating Lever. Then release, and run Adjusting Nut **toward** the Actuating Lever three full turns. Then operate the Clutch Lever. It should be just tight enough until you cannot force it into the break-over position. If not, continue until this condition exists. Lock with lock Nut.

### SAFETY CLUTCH

Each Gravely Model L Attachment has a Gravely Safety Clutch, which prevents sudden shocks from harming the attachment or tractor.

It is very important that these Clutches be adjusted correctly. If they are too loose, the Tractor will not drive the attachment efficiently. If too tight, it is possible that a sudden shock may injure the transmission or the attachment.

The proper method of field adjustment is as follows: Place a flat bar in the driving slots of the Slip Clutch. Hook a pair of spring scales on the bar 12" from the CENTER of the Clutch. Then adjust the spring tension by tightening or loosening the 6 bolts **EVENLY** so that it takes 40 to 45 pounds of pressure to make the clutch slip.

### CARBURETOR ADJUSTMENT

If it is absolutely necessary to adjust the Carburetor yourself, here is the proper way:

Find the **main jet** (needle valve). It is identified by having a brass T on it. Screw the T in until it is snug—be very careful not to force it or screw it tightly.

On the cast-iron carburetor (Model No. 9995), back it out 2 1/2 full turns.

On the aluminum die-cast carburetor (Model No. 0-12108), back it out 2 3/4 full turns. Start the tractor. Open the throttle about half-way, or to a fast idle. Let the tractor warm up. Then begin screwing the jet in slowly. As soon

as you hear the Motor slow down, STOP, and back the jet out 1/4 turn.

The **Air Jet** is a screw with a slotted head and a spring wound around the screw surface. Screw it all the way in, until it is snug.

On the cast-iron carburetor, back out two full turns.

On the aluminum die-cast carburetor, back out 1 1/2 full turns. Start the Tractor. Then begin screwing the Air Jet in until the Motor begins to "Buck", spit or backfire. Back out 1/8 turn. If motor is still rough, back out another 1/8.

Write for special Carburetor instructions. Be sure to give Make and Model Number of Carburetor.

### FAN BELT ADJUSTMENT

At some time or another you will need to adjust the Fan Belt. A thin wrench (1 1/2" opening) is helpful but not necessary.

Between the Fan Belt Pulley and the Fan Housing there is a thin, large nut. This nut locks the Fan Pulley Shaft to the Fan Housing. The shaft is in an elongated slot in the Fan Housing. When the nut is loosened, this will allow you to move the Fan Pulley up or down, to tighten or loosen the belt as needed. After the proper belt tension is obtained, simply tighten the nut down firmly.

If you do not have a thin wrench, remove the nut that holds the Fan Pulley in place. Then unscrew the Fan Pulley until you have sufficient room to get an ordinary wrench in to the nut. After adjustment, screw the Fan Pulley back in place and replace the nut.

### TIMING THE MODEL L ENGINE

Magneto should be set to fire 30 Degrees ahead of top dead center on the compression stroke (which is when both valves are closed).

To accomplish the 30 degree ahead of top dead center firing, proceed as follows:

1. Loosen Magneto Coupling bolt until the coupling moves on the Camshaft. It may be necessary to tap gently.
2. Crank Starter Pulley until you feel the beginning of the Compression Stroke. Remove Spark Plug, observe by eye or, more accurately, measure to piston surface until Piston is exactly at Top Dead Center.
3. Hold the Magneto Shaft Extension with Vise-Grip Pliers so it will not move after taking up gear backlash by moving pliers up gently. Rotate the Magneto Impulse (inoperative) until timing marks (**line** on **Coupling flange** and **dot** on **Magneto face**) line up.

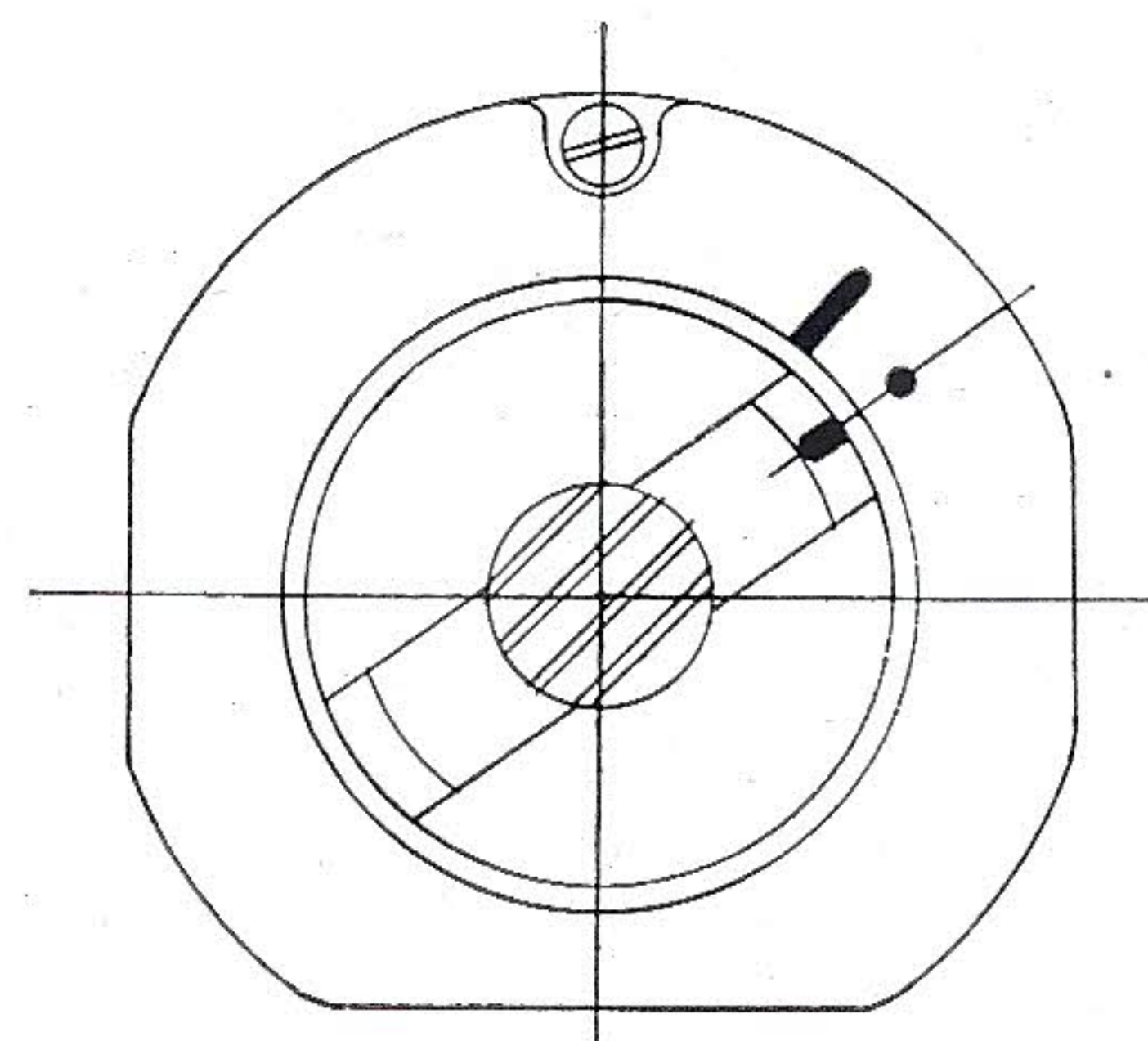

PLATE 11

4. Reassemble Magneto Coupling, inserting 1/64th (.015) Feeler between Fiber Block and the Coupling Flange before tightening Magneto Coupling so you will not cramp the impulse. Be sure timing marks are together while tightening bolt.

### STORING YOUR GRAVELY

Although the Gravely now has Attachments that make it a year-round tool, many of our Users do not use the equipment in the winter.

It is important, if you are not going to use the equipment for a time, to know how to store it properly.

1. Clean the Tractor thoroughly with kerosene and a stiff brush.



2. Store Tractor in a dry place. Jack it up by some means; usually this can be done by blocks under the axles.
3. Drain the Crankcase, flush with kerosene and refill with new oil. (Use a rust preventive oil if obtainable.) Operate the Engine for two minutes to distribute the oil. Do not get the Engine hot.
4. Remove the Spark Plug and put ½ pint of Mobiloil 10W-30 in the Cylinder. Turn over by hand several times: leave the Piston on top dead center, and then replace the Spark Plug.
5. Drain the Fuel Tank and Carburetor.

### TAKING THE TRACTOR FROM STORAGE

There are six important steps to follow if you want your tractor to start easily and work properly:

1. Drain out any rust preventive oil, and refill with Mobiloil A (SAE 30) or Mobiloil 10W-30.
2. Remove Spark Plug and put ¼ pint of Mobiloil 10W-30 (SAE 10) into the Cylinder. Turn over engine **by hand** (by twisting the starting pulley) several times. If Engine stops suddenly during this process, or if it turns over too easily, showing no compression, see: TROUBLE SHOOTING under "Sticking Valves." Replace Spark Plug.
3. Fill Fuel Tank with **fresh** Mobilgas (Regular).
4. Pump tires up to 20 pounds pressure.
5. If Oil Filter has not been replaced during the last season, it is best to replace it now.
6. Start your Tractor in the usual manner.

### HINTS ON HANDLING THE GRAVELY TRACTOR

The Gravelly is a wonderful tool to work with. You have power to spare for any ordinary—or extraordinary—lawn, garden, or field job. It will save you many hours of drudgery, help you have a better looking home, give you much pleasure in your home or small farm.

These few little tips on how to handle a Gravelly will add to that pleasure. Some of them will take a little practice but it will be time well spent.

#### NUMBER ONE: LET THE TRACTOR DO THE WORK!

The most common mistake of a beginner with a Gravelly is to try to help the Tractor. Just remember this—the Gravelly is much more powerful than you are. Guide it—don't try to manhandle it. Let the tractor do the work! All the pushing you do is wasted effort. All the attempts to hold back will just wear you out. So take it easy!

Stand erect behind the tractor. **Stay out from between the handles.** Hold the handles in a firm but relaxed grip. Walk or ride relaxed and at ease. The Tractor will obey your will—learn to use the gears, and to feed the fuel as needed.

Give with the Tractor in unusual situations. Always remember the Tractor is stronger than you—like a horse. Ride with it, and you will always have control.

#### NUMBER TWO: KEEP YOUR TRACTOR TIGHTENED UP.

Have a regular time to go over the Tractor and tighten up the bolts and nuts. When you are working, take a rest occasionally and check your Tractor. Common sense and good care will save you money, let your tractor do its work more efficiently, save you drudgery.

#### NUMBER THREE: SLIPPING THE CLUTCH.

Occasionally you will find yourself in the position that your Tractor's ground speed (forward motion) is a little too fast to do the job right. The tendency is to slip the Clutch. But in every case, usually by taking a slightly smaller "bite" at the job it will not be necessary to slip the clutch. The less you slip the Clutch the longer the Clutch will last.

#### NUMBER FOUR: NEVER WORK AROUND AN ATTACHMENT WHEN THE ATTACHMENT IS IN GEAR!

As a matter of fact, the safest thing to do is to stop the Tractor Engine whenever you have to do anything to the power Attachments.

#### NUMBER FIVE: KEEP YOUR FINGERS AWAY FROM THE FAN AND THE FAN BELT.

If you have to work around the Fan or the Fan Belt, STOP the tractor!

#### NUMBER SIX: WHEN USING REVERSE, KEEP YOUR HAND ON THE LEVER.

The Gravelly is a powerful machine, and it can't think for you. If you put the machine in reverse, and come back too fast, you may stumble, fall, or get pinned against a wall or fence. Always slow down when reversing, keep your hand on the lever, and take it easy. Then if something unexpected happens, you can jerk the lever into neutral and the Tractor will stop.

#### NUMBER SEVEN: DON'T BE AFRAID OF THE EQUIPMENT.

The Gravelly is a tool. Like any other tool, it deserves respect, but it is made to be used—made to help you do your lawn, garden and field tasks. Master the equipment and you will find many pleasant hours of relaxation ahead—time when you can be accomplishing a lot of work, and yet have a good time doing it. There is something fascinating about a Gravelly, as you will learn. Soon you will have the same affection for it as you have for your faithful car, your favorite gun or fishing rod.

Just remember—let the Gravelly do the work!

### TROUBLE-SHOOTING

Your Gravelly Tractor, like any mechanical product, may break down or be out of adjustment occasionally. This section will deal with those problems that can be corrected in the field by even the "non-mechanical" person. If these remedies do not solve your problem, call your Gravelly Dealer. His mechanics are trained in factory methods, have the special tools to repair your equipment quickly and efficiently.

Some of the problems in the field are caused by operator inexperience. This is especially true during the first few weeks of use. After you have become familiar with your Tractor and equipment, these "difficulties" will vanish, because you will know what to do.

#### TROUBLE: Tractor Engine Fails to Start

##### Cause and Cure:

1. Out of gasoline.
2. Not getting Fuel because the Fuel Cut-Off Valve on the Sediment Bowl under the Fuel Tank has been turned off. Be sure it is open. (Turn counter-clockwise.)
3. Carburetor Flooded. Carburetor will be wet if this condition is present. This is caused on some older tractors and on an occasional new tractor by leaving the Fuel Valve open for a period of time, and gasoline draining down into the hose. To check, remove Air Cleaner hose from the air intake side of the Carburetor and hold down. If fuel runs out, drain the hose completely and replace. Be sure Choke Lever is turned all the way Counter-clockwise, and start engine. **DO NOT START OR RUN ENGINE WITHOUT AIR CLEANER HOSE IN POSITION AND CLAMP TIGHTENED.** If you do, you may score the cylinder or ruin the rings. It only takes a few minutes, in dusty conditions, to ruin the engine and cost you a repair bill.
4. Spark Plug shorted out by contacting a bent or damaged Tractor Hood, especially if the rubber cap is split, worn through, or absent. To check, lift hood and attempt to start Tractor.
5. Spark Plug fouled or wet. To correct, remove, clean, or dry, reset at .033. Be sure you are using an Autolite TT-10. Air-cooled engines with Impulse coupling-type Magnetos require a "hot" plug as furnished with tractor. If you have substituted a different plug, you may run into starting trouble.
6. Not getting spark from Magneto. Remove Magneto Cable from Spark Plug. Crank tractor, holding cable end so the spark will jump to the Cylinder Head. If no Spark when Impulse "clicks", or weak spark (less than 3/16", check connections. If connections are all right, Magneto is bad. Call your Dealer.
7. MAGNETO HANDLE STOP SWITCH. Dealers have been, upon customer requests, installing various types of Handle Stop Switches. Check to be sure it is ON. If it is, and your Tractor is wet from dew or rain, or has been exposed to them recently, some of the switches have been found to short out due to this moisture. To check, disconnect from Magneto and try to start Tractor.
8. AIR CLEANER STOPPED UP. The new Dry-Type Air Cleaner has a built-in Safety feature to protect your Tractor. When it is loaded to capacity with dust and grit it has kept from reaching your engine, air will not go through it, and your Tractor will not start. To Check, Remove Air



Cleaner Hose at the Carburetor Intake, and attempt to start Tractor. If it starts, SHUT IT OFF IMMEDIATELY and change Air Cleaners. IF YOU RUN THE TRACTOR WITHOUT THIS CONNECTION TIGHT, OR WITH HOSE REMOVED, YOU WILL SCORE THE CYLINDER, INTRODUCE DUST THAT WILL WEAR RINGS OUT VERY RAPIDLY (IN A MATTER OF MINUTES) AND COST YOURSELF AN EXPENSIVE REPAIR JOB.

(**Caution:** Sometimes this method will start the tractor, IF enough fuel has collected in the Hose to give a vapor lock. If fuel drains from hose when disconnected and held downwards, **flooding** is the problem. In this case, drain hose, reconnect, and start tractor.)

9. Sticking Valve. Tractors with **Manufacturing Number B-9700** and above RARELY have this problem. If your Tractor is an older model, call your Dealer. He can give you quick instructions for temporary cure, and install the permanent remedy at low cost. To diagnose: a Stuck Valve, Exhaust, will allow you to turn the engine over rapidly, and there will be no compression. A Stuck Valve, Intake, will allow you to turn the engine over to a certain point, then it will stop. Turning the engine **backwards**, the engine will stop at that same point.

10. Vent in Gas Tank Cap stopped up. This gives a vapor lock. Remove Cap, allow Fuel to evaporate, Blow through vent. Or use a thin wire (safety or straight pin will do it) to clean out.

11. No fuel moving from Tank. For engine protection, the Sediment Bowl contains a screen, and the Fuel opening from the Tank is small to keep foreign matter from the Carburetor and engine. To check if fuel is moving, unscrew the small nut which holds the Sediment Bowl in position. If Orifice or Screen is not clogged or stopped up, Bowl will overflow. Replace Nut. If no Fuel flows, Clean Orifice in tank and/or screen in sediment bowl and start Tractor.

12. Timing: This is a complex subject. If you have gone through the check list above and your Tractor still does not Start, check the Timing by:

1. Rotate tractor Engine by hand until you feel the beginning of the compression stroke. Remove Spark Plug.

2. Continue rotation by hand until the piston is at top dead center, with both valves closed. Observe by eye, or more accurately, measure to Piston Surface, to be sure Piston is at top dead center.

3. At this point, Impulse on Magneto should "click". If it does not, you have an out-of-time engine. Call your Gravelly Dealer.

**IMPORTANT:** The Gravelly Tractor should start with one, or occasionally two, pulls on the strap. If it does not, you have one of the problems in this check list. Don't wear yourself out trying to pull on the Strap or grind the Starter . . . find the trouble so you can proceed with the easy, efficient starting the Gravelly is manufactured to give you. **DON'T START ADJUSTING THE CARBURETOR.** If a Carburetor is out of adjustment, the Tractor will still start . . . and if adjustment is needed, it must be done when the tractor is running. You will just add to your problems if you start fooling with the Carburetor Adjustments.

## LAWN EQUIPMENT

### REEL MOWER INSTRUCTIONS

By attaching the 30" Reel Mower to your Gravelly Tractor, you have one of the finest lawn mowers money can buy.

#### ATTACHING

The Gravelly Reel Mower (30" Center Unit) is attached to the front of the Tractor by four bolts, as are all power attachments.

#### LUBRICATION

The Swivel Casting is equipped with an Alemite Fitting. This should be given a shot of Mobilgrease MP occasionally, to keep the Swivel lubricated and to prevent rust. (See Plate 12 for lubrication points.)

The Gear Housing should be drained at least once a year, and new oil put into it. To drain, remove the entire M-153 Strut Casting of the Gear Housing.

To replace the oil, or to add oil when needed, remove the Gear Housing Oil Plug and the Oil Level Pipe Plug. Fill the Gear Housing with Mobilube GX-140 until the oil is level

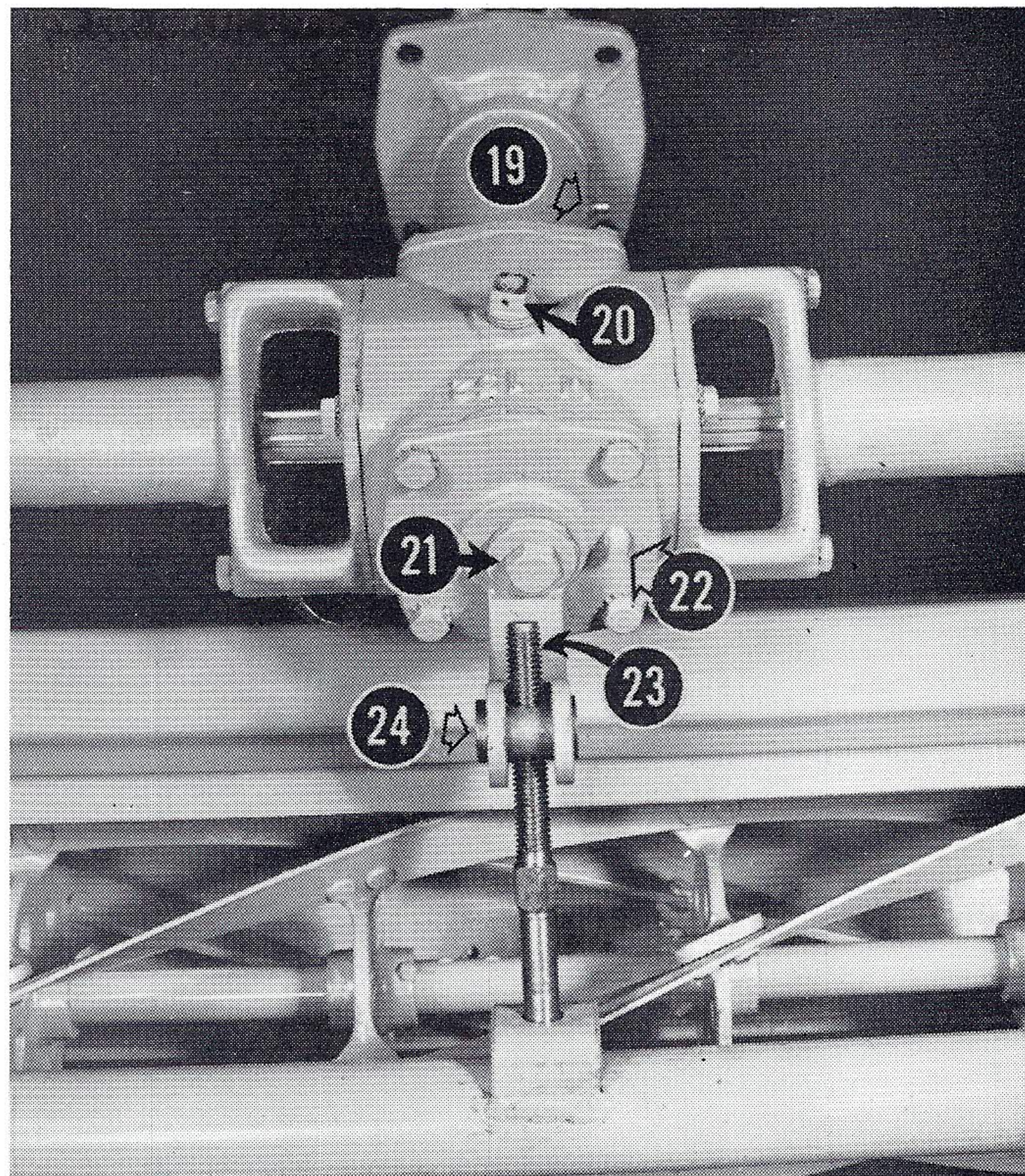

PLATE 12

- |                            |                         |
|----------------------------|-------------------------|
| 19. Swivel Alemite Fitting | 22. Oil Level Plug      |
| 20. Oil Filler Plug        | 23. Adjusting Screw     |
| 21. Shifting Fork Bolt     | 24. Adjusting Screw Nut |

with, or begins to run out of, the Oil Level Hole. Never use more oil than is needed to fill the Gear Housing to the bottom of the Oil Level Plug. Too much oil will cause overheating and consequent damage to the gears. Be sure to replace **both** Plugs before you begin mowing.

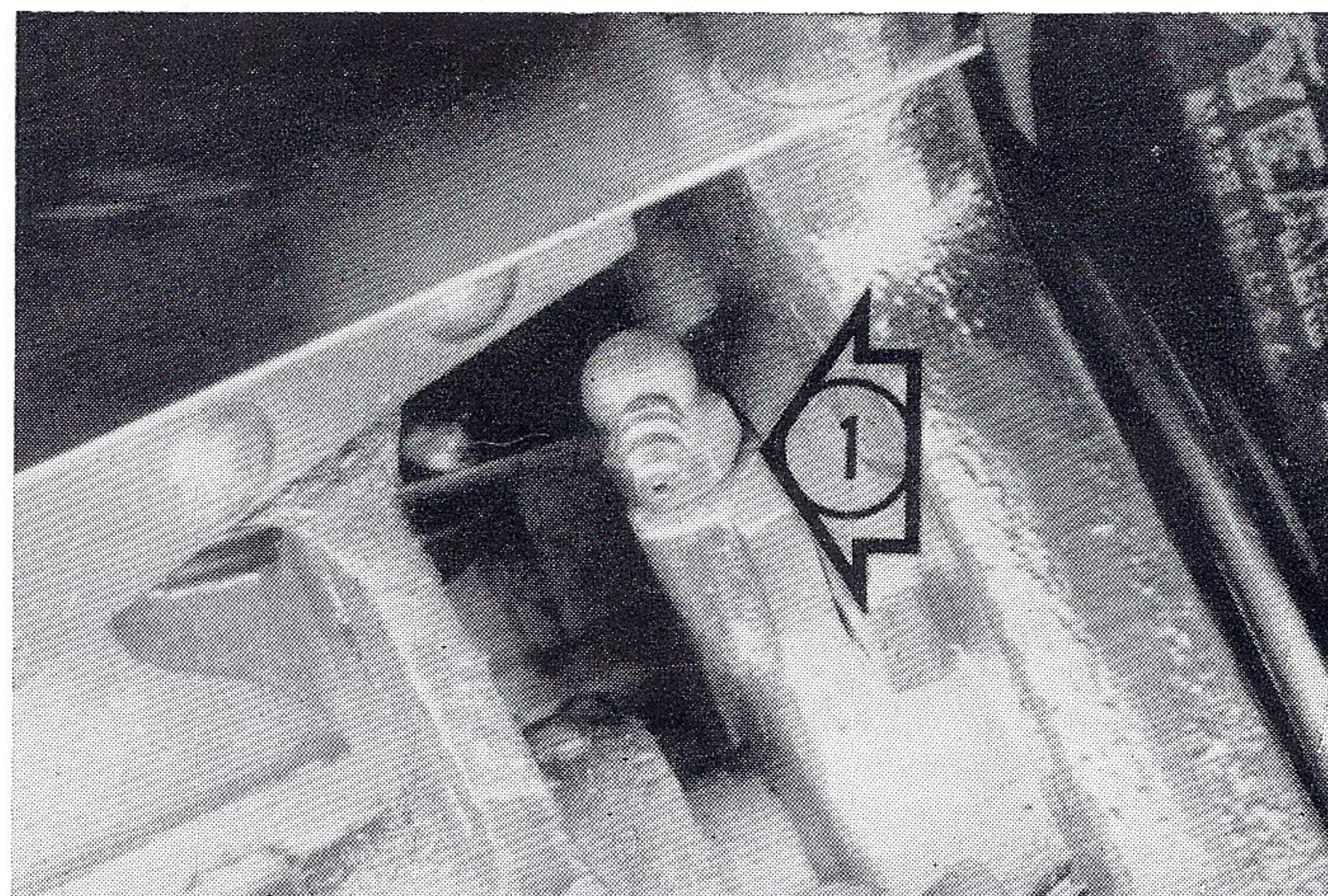

PLATE 13

1. Reel Alemite Fitting (2 per unit)

The Reel Bearing Alemite fittings should be given a shot of Mobilgrease MP as needed. This lubrication is very important, for the grease forms a water seal around the bearing. Neglect will cause the Reel Bearing to rust, and a repair job of replacing the bearing and readjustment of the Reel. (See Plate 13.)

There are two Alemite fittings on the Roller Bar. Use Mobilgrease MP in these fittings, as needed to insure free rolling.

#### ADJUSTING THE HEIGHT OF CUT

Cutting height is adjusted by means of the Height Adjusting Screw and (See Plate 12) Height Adjusting Screw Nut.



Turn the Height Adjusting Screw to the right to raise the height of cut, and to the left to lower the height of the cut.

#### REVERSE LAPPING OF REEL

The Reel Mower has a specially designed reverse for lapping the Reel against the Bed Knife. This will eliminate, in some cases, grinding the Reel. It is advisable to lap the Reel whenever the Reel adjustment against the Bed Knife Bar is changed radically.

To lap the Reel, loosen the bolt on the front of the Gear Housing. (Plate 12.) (Be sure tractor is stopped, attachment out of gear.) This bolt is off center. To reverse the Reel, slowly roll the Reel back and forth with the hand, pushing the bolt to the opposite side of the housing. This engages the reverse. When it is engaged, tighten the bolt.

Then apply a 60 grit lapping compound to the Reel with a paint brush with the attachment running at normal speed. (Watch your fingers!) Allow the Reel to lap in reverse until the Reel makes good contact with the Bed Knife Bar along its entire length.

To put the Reel back in forward gear, use the same procedure as described above, except push the bolt to the right and lock by tightening.

#### REEL ADJUSTMENT

The correct adjustment of the Reel means the difference between a good mowing job and a poor one. To test the adjustment, use a piece of paper at different points on the Bed Knife Bar and turn the Reel with your hand.

To do a good job, the Reel must cut the paper evenly along the Bed Knife Bar. Reel Blade **must not** contact the Bar. If the Knife cuts the paper cleanly at each point, the Reel is in adjustment. If the Knife does not cut the paper cleanly at all points, you must adjust the Reel.

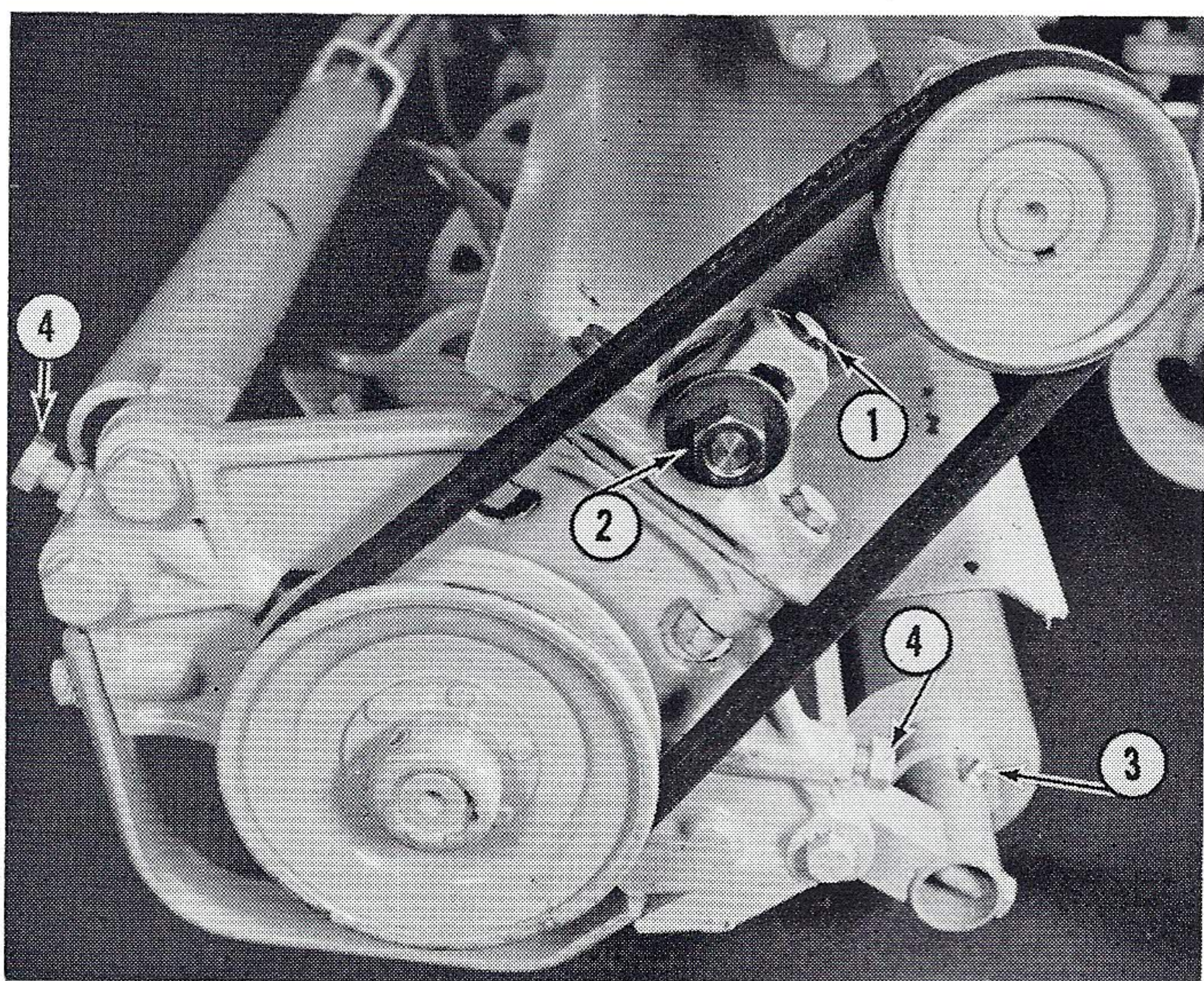

PLATE 14

- |                                   |                                     |
|-----------------------------------|-------------------------------------|
| 1. V-belt Adjustment Bolt         | 3. Roller Bar Alomite Fitting       |
| 2. V-belt Adjusting Bolt Lock Nut | 4. Reel Adjusting Bolts & Lock Nuts |

To adjust, loosen the Locking Nut and turn the Rear Screw (See Plate 14) either left or right. Tightening (turning to the right) will move the Reel away from the Bed Knife Bar. Loosening (turning to the left) will allow the Reel to press harder on the Bed Knife Bar.

For example, suppose that you are facing the Reel, and have tested the cut. You find that the Reel pressure is light on the left side, heavy on the right.

Loosen the Lock Nut on the Rear Left Adjusting Screw, then loosen the Screw slightly. Loosen the Lock Nut on the Rear Right Adjusting Screw, and **tighten** the Screw slightly. Test. Repeat if necessary. Then tighten the Lock Nut to hold the adjustment.

#### INSTALLATION OF V-BELTS

To install the V-Belts. Turn the Height Adjusting Screw until it releases the Reel Assembly from the Strut.

Raise the Mower slightly and swing the reel backwards (toward the tractor) until the belts are loose on the pulley.

Remove the old belts and replace with the new belts. After the new belts are in place, return Reel Assembly to normal position, replace the Height Adjusting Screw and readjust the mowing height.

#### ADJUSTMENT OF V-BELTS

Your mower is equipped with a special V-Belt Adjustment Bolt (See Plate 14). The V-Belts should have one inch of play in them. That is, without forcing, but with firm pressure on one side of the V-Belt (halfway from each pulley), it should give one inch.

To tighten, loosen nut No. 2 (Plate 14), and turn the Belt Adjusting Bolt clockwise. To loosen, turn the Belt Adjusting Bolt counter-clockwise. When tightening, if the Belt Adjusting Bolt is turned as far as it will go and the belts do not tighten, the belts should be replaced. After adjustment, re-tighten nut (2 in Plate 14).

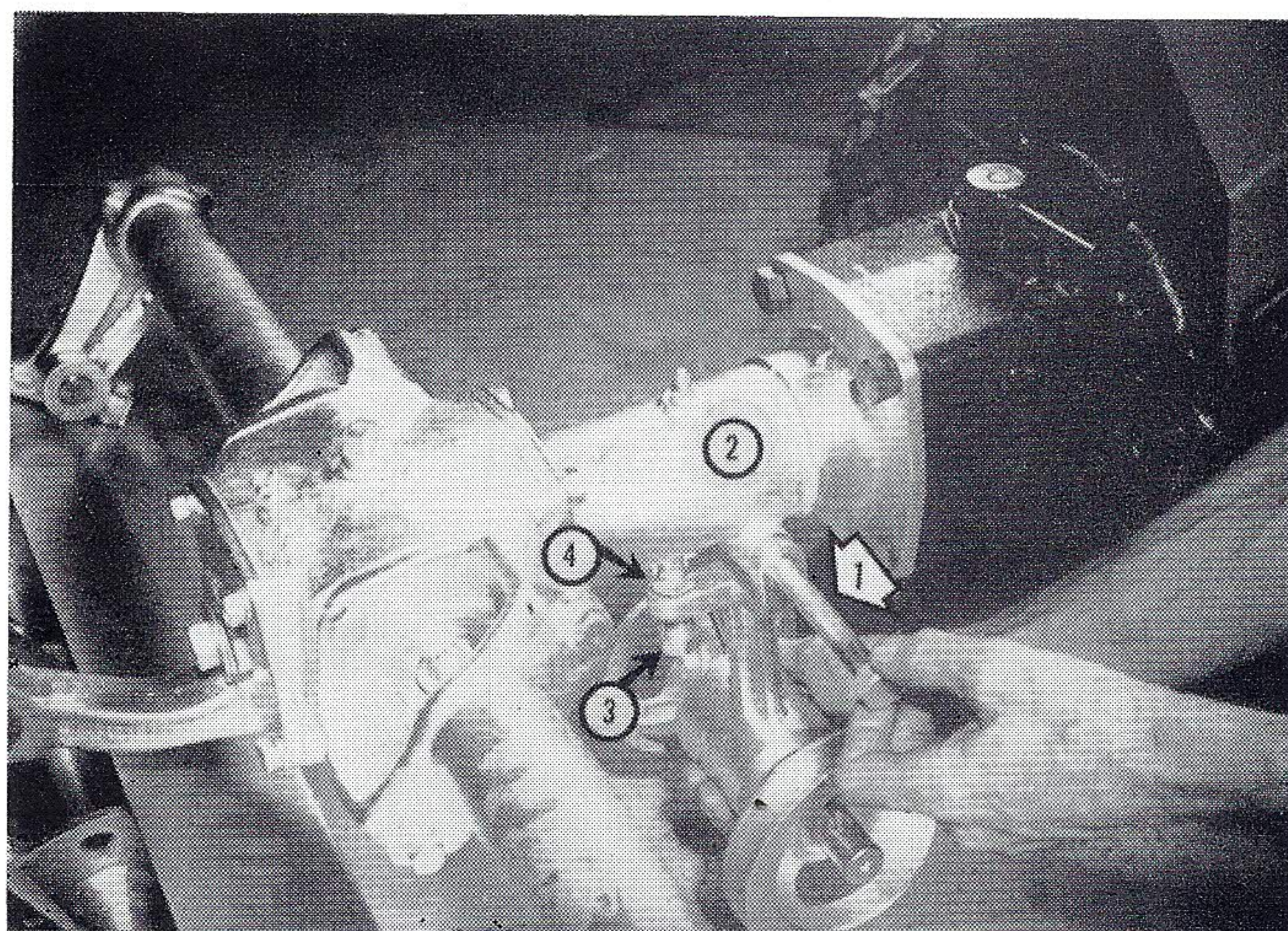

PLATE 15

- |                              |                                  |
|------------------------------|----------------------------------|
| 1. Wing Bracket Bolt         | 3. Belt Adjusting Screw          |
| 2. Reel Mower Swivel Casting | 4. Belt Adjusting Screw Lock Nut |

#### GANG MOWERS

Large mowing areas deserve the same care and treatment that you give your smaller areas. By attaching two 25 inch Gang Mowing Units to your Gravely Rotary Mower, your large lawns can be mowed in a minimum of time. Like the Reel Mower, they have Swivel Action which allows them to follow the contour of the ground. They do not depend upon traction for power—they are completely power driven from the tractor.

With the Gang Mowing Units attached to your Reel Mower, you mow a swath 75 inches wide—and the mowing is done cleanly and evenly.

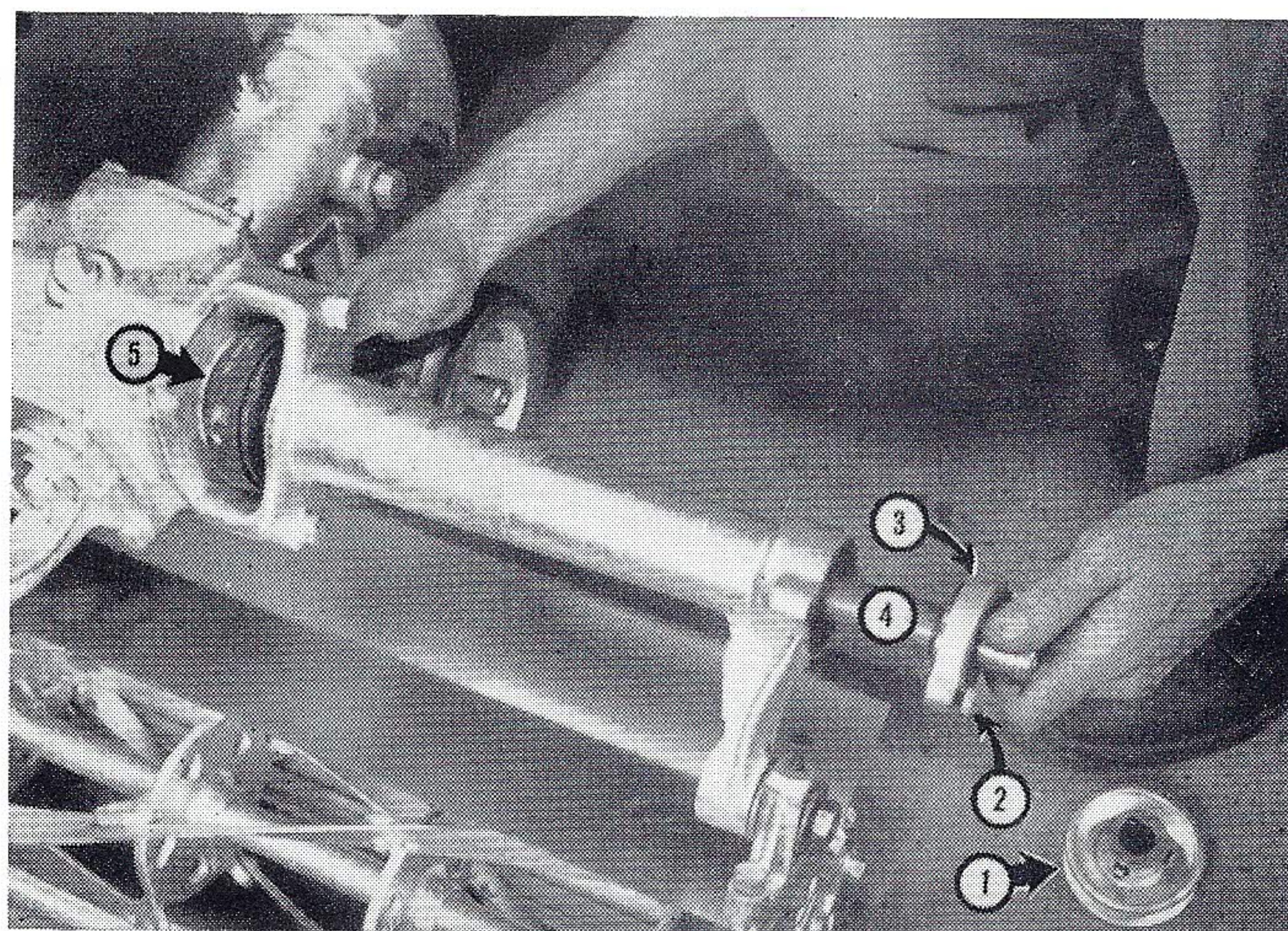

PLATE 16

- |                                  |                                      |
|----------------------------------|--------------------------------------|
| 1. Outer Drive Shaft Pulley (3") | 4. Outer Cross Shaft                 |
| 2. Bearing Cap Screw             | 5. Belt and Inner Drive Shaft Pulley |
| 3. Bearing Cap                   |                                      |



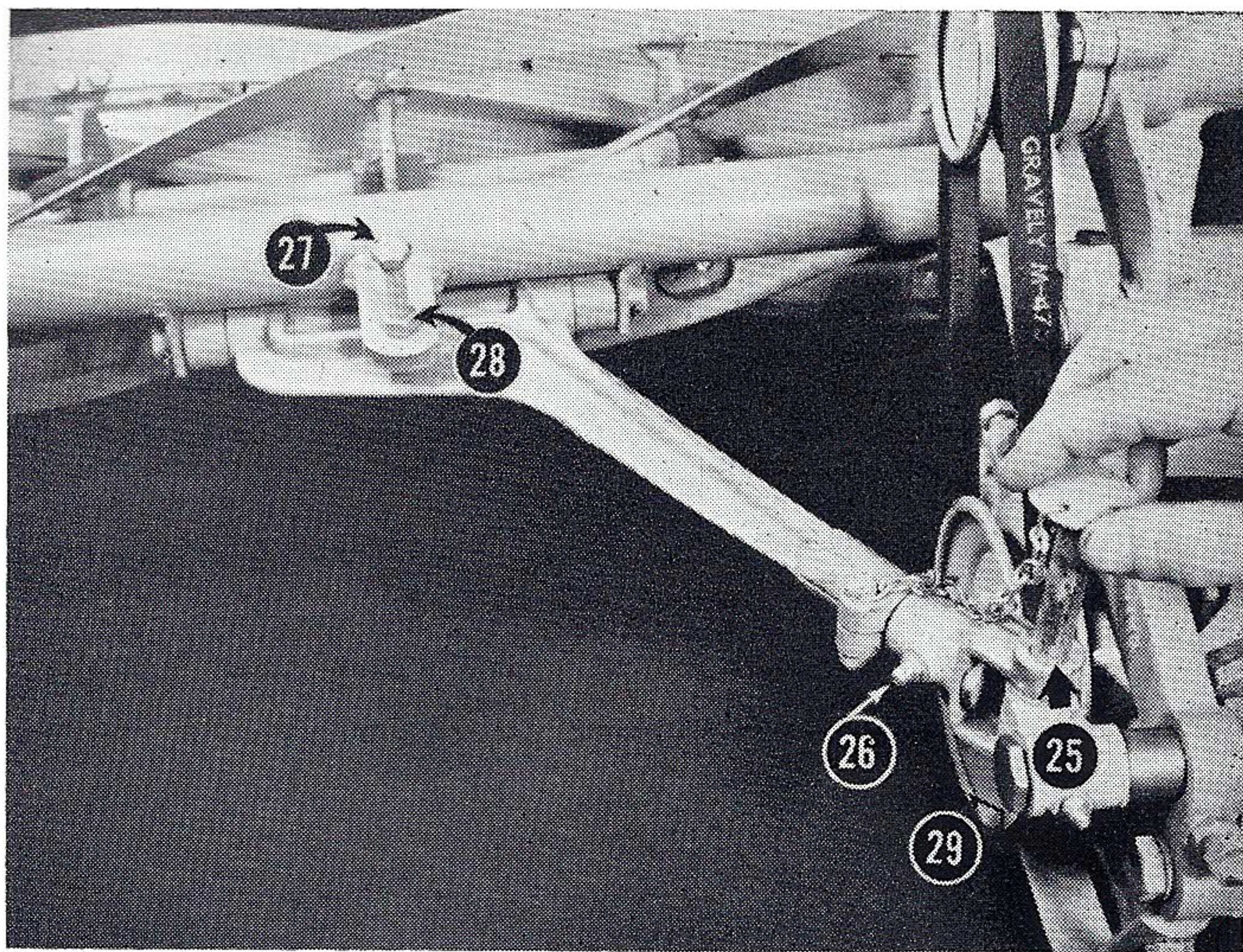

PLATE 17

- |                                   |                                     |
|-----------------------------------|-------------------------------------|
| 25. Leader Swivel Pin             | 27. Height Adjusting Screw          |
| 26. Leader Swivel Alemite Fitting | 28. Height Adjusting Screw Lock Nut |
| 29. Pivot Stud                    |                                     |

#### ATTACHING

The Gang Units are attached to the Center unit (30" Reel Mower).

They come to you in three assemblies: 1. The Power Take Off, 2. Universal Drive Assembly, 3. The Leader (attached to the Gang Unit).

#### ASSEMBLY OF POWER TAKE OFF

The Power Take Off for the Gang Units is assembled to the Center Unit as shown in Plate 15.

#### ATTACHING BELTS TO POWER TAKE OFF

First, remove the belts from the pulleys on the Center Unit, by the method discussed in the "REEL MOWER" Instructions.

Remove the outer Drive Pulley, first loosening the Allen set screws.

Loosen the Bearing Cap Screws, and pull the Outer Cross Shaft assembly out until it is possible to insert the Inner Wing Drive Pulley (Splined) and Belt into the opening as shown in Plate 16.

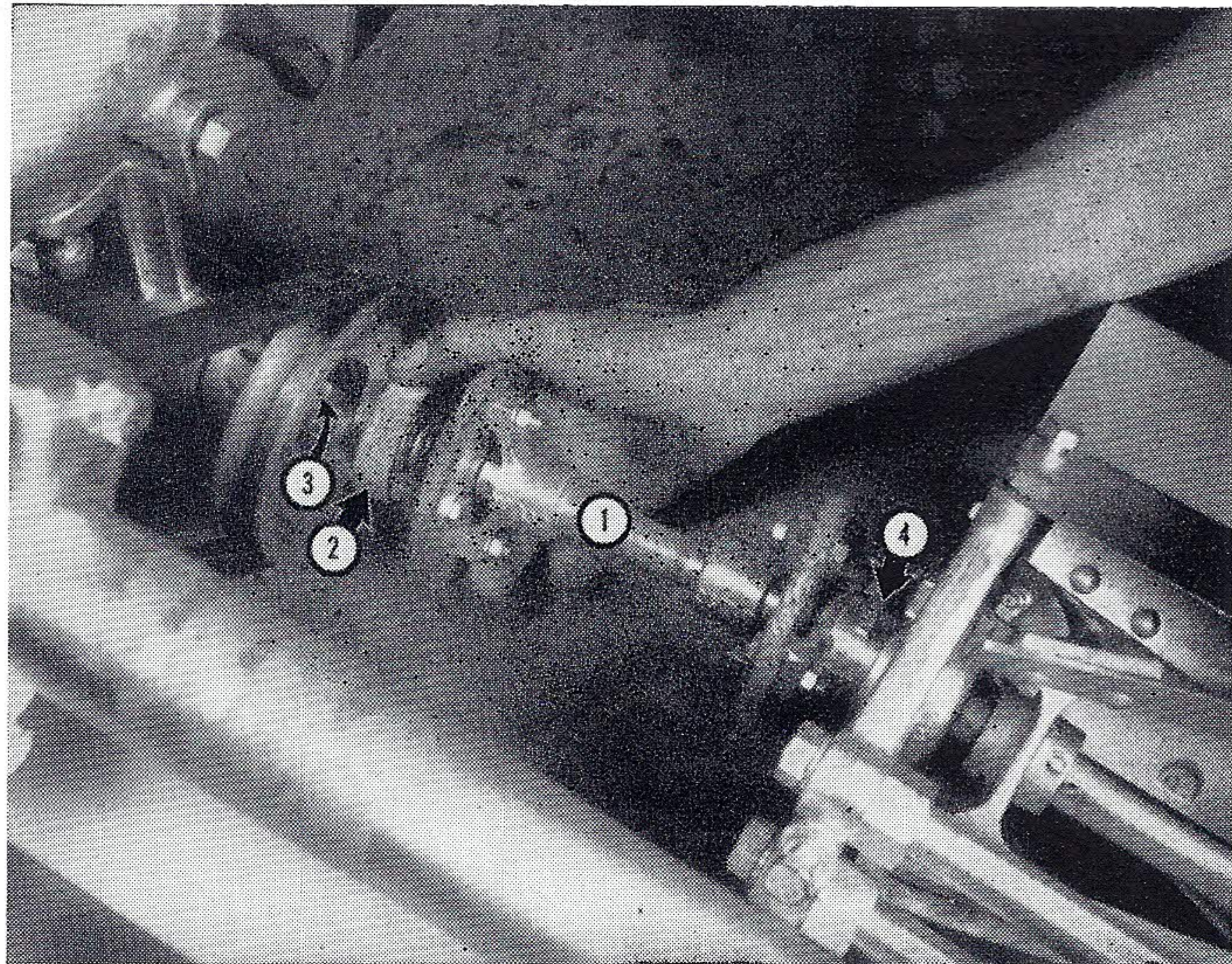

PLATE 18

- |                             |                                      |
|-----------------------------|--------------------------------------|
| 1. Universal Drive Assembly | 3. Locking Ring Ball Receiving Holes |
| 2. Locking Ring             | 4. Wing Spider                       |

Replace the Outer Cross Shaft, through the Inner Drive Pulley, turning slightly as needed until it engages the gears in the housing. Replace all parts. Tighten set screws in Splined Pulley, (Plate 16, Number 5).

#### ATTACHING LEADER

Remove the Top tie Rod Bolt, replace with the Leader Pivot and Leader Pivot Stud as shown in Plate 17.

Attach the Leader Swivel with the Leader Swivel Pin, as demonstrated in Plate 17.

On a new mower, the Leader Swivel Pin may not drop easily into place. This is caused by a protective film of paint on this pin and paint film on inside of the holes. A quick rub with very fine emery paper will remove the paint coating, and the pin will drop into place easily.

#### ATTACHING UNIVERSAL ASSEMBLY

The Universal assembly is attached to the Reel Shaft by Set Screws. First, place the Wing Spider in position and force on the shaft until it is **seated** in place **against the Reel Shaft Bearing**. Then tighten the set screws. (See Plate 18.)

To attach the Universal to the Power Take Off, Grasp Locking Ring as shown in Plate 18, pulling it back against the spring. Then place the Assembly on the Power Take Off Shaft, so the Locking Ring Balls will be in line with the holes on the Power Take Off Shaft. Releasing the ring will then lock the Universal securely to the Power Take Off Shaft. To remove, simply reverse the procedure.

#### ADJUSTMENTS

##### WING DRIVE V BELTS

Tension of the Wing Drive V Belts is adjusted by a bolt and lock nut on the Power Take Off. (See Plate 15.)

Turning the bolt to the right **increases** tension, to the left **decreases** tension. Proper tension is found by applying firm pressure in the center of the belt. It should "give" approximately one inch, without forcing.

##### LEADERS

The Gangs must run parallel to the Center Unit for best results.

##### CUTTING HEIGHT

Cutting Height is adjusted by means of the Wing Height Adjusting Screw. (See Plate 17.)

Loosen the Lock Nut, turn the screw Clockwise to **INCREASE** mowing height, counter-clockwise to **DECREASE** mowing height. When properly adjusted, tighten lock nut.

##### LUBRICATION, REEL ADJUSTMENTS, ETC.

All other adjustments and lubrication exactly the same as for the Center Unit.

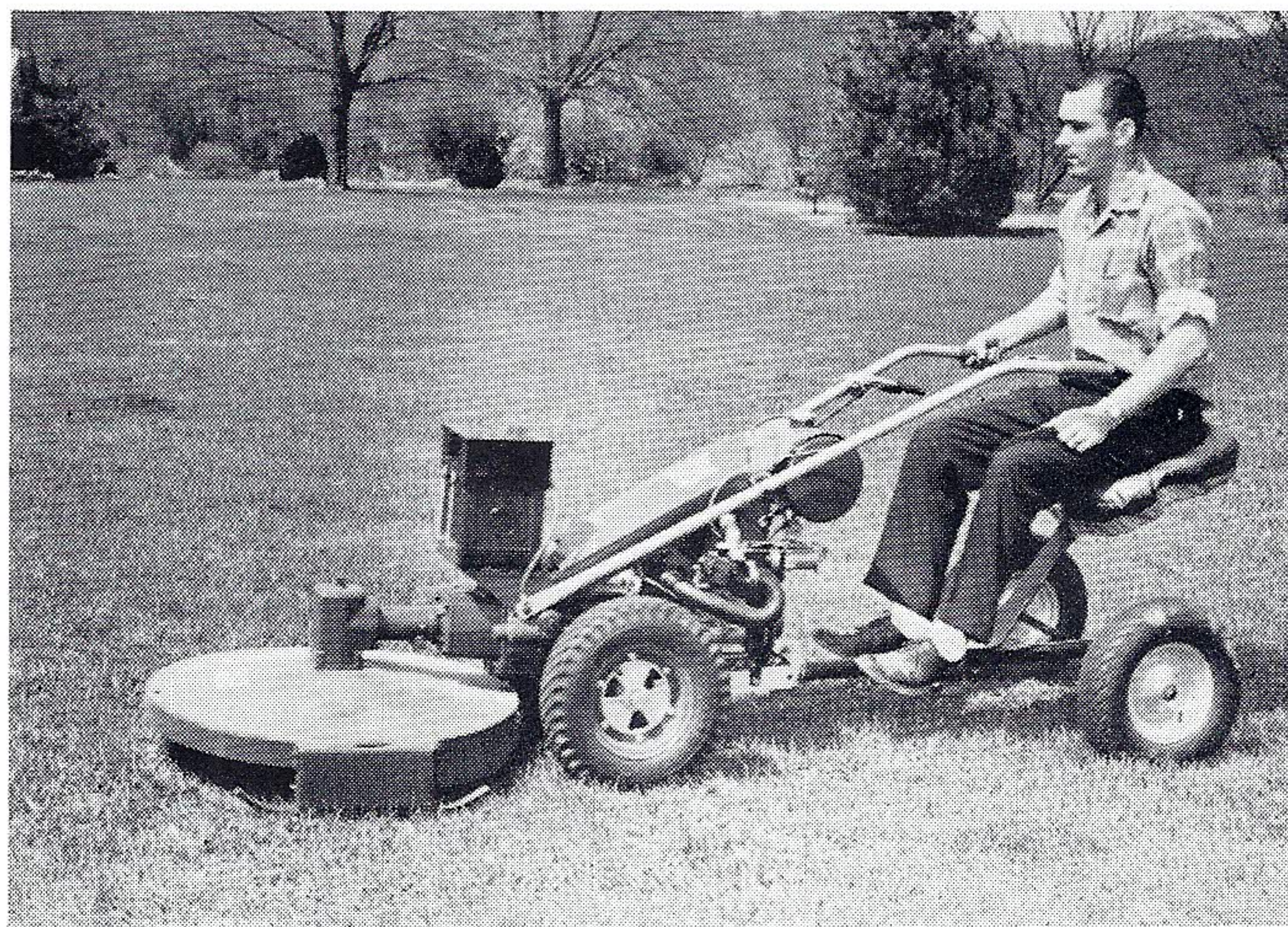

PLATE 19

#### ROTARY KNIFE MOWER

The Rotary Knife Mower is a versatile mower that mows the finest lawn grass or the toughest weeds. It has very low maintenance, because of its simple construction and minimum of parts, and mulches cut grass to a finely shredded material that makes lawn raking unnecessary under normal conditions.



## Combination:

# ROTARY MOWER - LEAF MULCHER CHAIN SAW - CIRCULAR SAW

With this combination you can perform four different kinds of work. 1. cut timber, 2. clear land, 3. mow lawns, weeds and brush, and 4. mulch leaves—all with the same power drive. To change from job to job, simply switch the tool you want to use!

**All of these tools are used on the same drive!**

### ATTACHING DRIVE

The drive is attached to the front of the Tractor by four bolts, like all other power attachments.

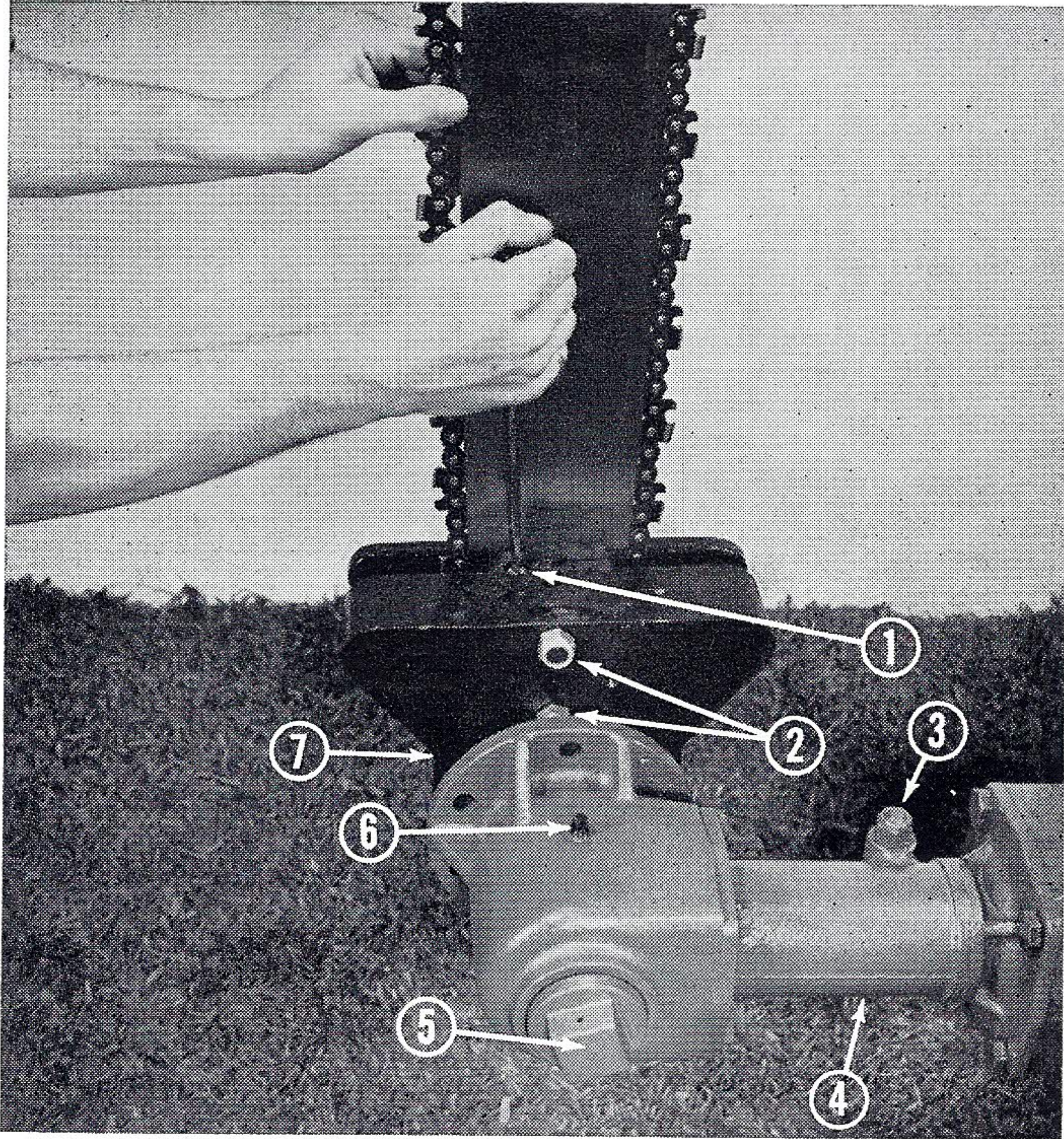

PLATE 20

(1) Chain Adjusting Screw, (2) Guide Bar Clamp Bolts, (3) Angle Adjustment Bolt, (4) Swivel Alemite Fitting, (5) Oil Filler Hole Plug, (6) Oil Level Hole Plug, (7) Bracket Clamp Nut.

### LUBRICATION

On the Swivel Casting is an Alemite fitting. This should be given an occasional shot of Mobilgrease MP as needed.

On the Drive is an Oil Filler Plug (large) and an Oil Level Plug (small). (See Plate 20.)

Remove both Plugs. Fill with Mobilube GX-140 until oil begins to run out the Oil Level Hole.

Be careful not to use too much oil . . . when it is level with the Oil Level Hole, stop.

Replace both plugs before operating the Attachment.

### ADJUSTING SWIVEL ACTION

On the bottom of the Swivel Casting (Part No. A-149), is a Boss, and you will notice that the casting is split at that point, with a large bolt and nut through the Boss.

When using the Rotary Knife Mower, the Swivel should be loosened until the Mower will follow the ground contour with its own weight. When using the Circular Saw or the Chain Saw, usually you will be using the same adjustment as a clamp, to hold the Saws in the position desired. To

clamp, simply turn the attachment to the point desired, then tighten the bolt down firmly.

## ROTARY KNIFE MOWER

### ATTACHING

Remove the other tools (Chain Saw or Circular Saw), if on the drive, by reversing the process as described under "Attaching" in the appropriate instructions.

Remove the Drive from the Tractor, and turn it upside down . . . that is, the attachment Drive Shaft should be pointing up.

Find the model number on your Rotary Mower Drive. On Drives with model numbers 185, 58-A, and 58 through 52—Remove the Bolts and Bolt Clips from the Housing.

Set the Rotary Mower Hood in place with the Rear Fender toward the Safety Clutch end of the Swivel Housing.

Place the Bolts and Bolt Clips in place, tighten down firmly. Bend Tangs of Clips around Bolt Heads.

When assembling model 106 Rotary Mower—place 6 Bolts and plain  $\frac{1}{2}$ " Washers through holes in Mower Hood and Gear Housing Flange, from the Knife side of the Hood. Then place Lock Washers and nuts on end of Bolts showing through Gear Housing Flange. Tighten Bolts very tightly.

The Model Number of the attachment will be found on the Drive Casting. Model numbers 52, 53, 54, 55, 56, 57, take the R0-321 Knife. (Left hand rotation.) Model numbers 58, 58-A, 185, 106 take the R0-336 Knife. (Right hand rotation.)

To assemble, use the collars in any order you wish. Always be sure the counter-bored side of the collars face the knives.

### ADJUSTING HEIGHT OF CUT

The height of cut is adjusted by these Collars. The closer the Knife is to the Housing, the higher the cut, and vice versa. By using different combinations of the three different sized Collars, you adjust the height.

ALWAYS be sure the COUNTER-BORED sides of the Collars are FACING THE KNIVES.

### SHARPENING

The knife may be sharpened by a file, or a grindstone. Attempt to follow the same bevel as the Knife had when you obtained it, although the exact degree of bevel is not critical.

### WARNING

Never put your feet or your hands under the Hood of the Rotary Knife Mower while the Attachment is running, or for an interval after you shut off the Attachment. Always make sure the knives have stopped spinning before placing your hands or feet near the Hood.

### GUARD ADJUSTMENTS

When mowing short weeds and lawn grass, the Small Fender should be in front, and the Large Fender in back.

THESE FENDERS SHOULD ALWAYS BE IN PLACE WHENEVER YOU ARE MOWING IN A PUBLIC PLACE, NEAR A HIGHWAY OR BUILDINGS, WHEN PEOPLE ARE NEAR THE AREA YOU ARE MOWING.

However, when you begin mowing in very high, heavy brush, or in very thick, tough grass of considerable height, better mowing results will be obtained if you remove the Front Fender, leaving the front of the mower open.

**WARNING:** When this is done, there is danger from material being thrown from under the mower, forward. Rocks, tin cans, steel objects should be removed from the area, and great care exercised. NEVER MOW WITH GUARDS REMOVED IN PUBLIC PLACES, OR WHERE PEOPLE OR PROPERTY CAN BE DAMAGED BY PROJECTED MATERIAL.



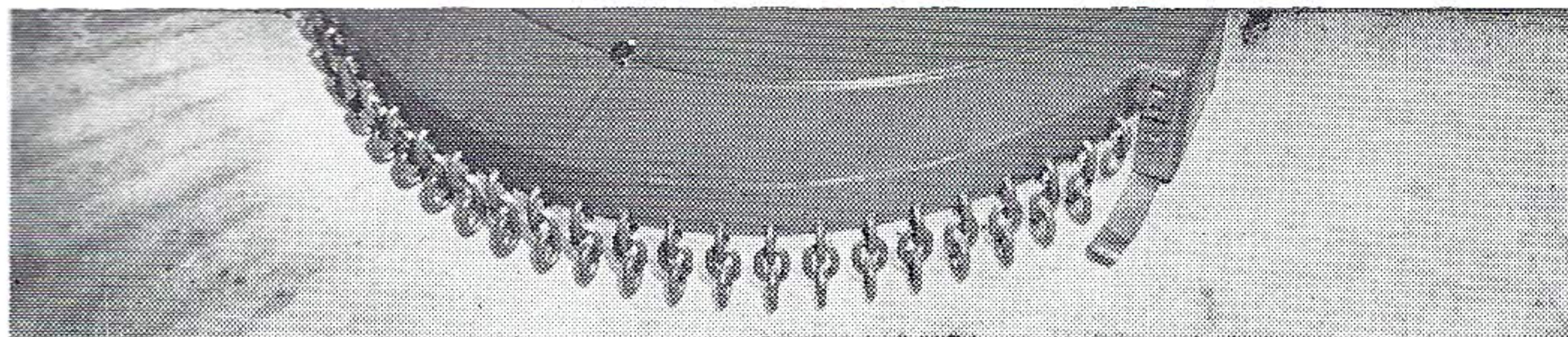

PLATE 21

#### OPTIONAL CHAIN GUARD

Under certain special conditions, a Gravelly Chain Guard may be desirable. Completely encloses front of Mower, with a chain curtain to reduce the velocity of materials that may be thrown out.

#### LEAF MULCHER

##### ATTACHING

Attach the Rotary Knife Mower to the Tractor in the same manner as previous instructions designate.

Remove the Front and Rear Fenders. Put the Rear Fender on the front of the Rotary Knife Mower.

Put the Leaf Guard on the Rear of the Rotary Knife Mower.

##### OPERATING

To operate the Leaf Mulcher, proceed as though you were mowing. Ordinarily, normal walking speed will be sufficient to do a good job. If using on wet, concentrated leaves, it may be necessary to go over them twice to get all the leaves.

##### CAUTION

Keep hands and feet away from the attachment while in gear and for an interval after being shut off. Be sure knife has stopped revolving before putting hands or feet under the hood!

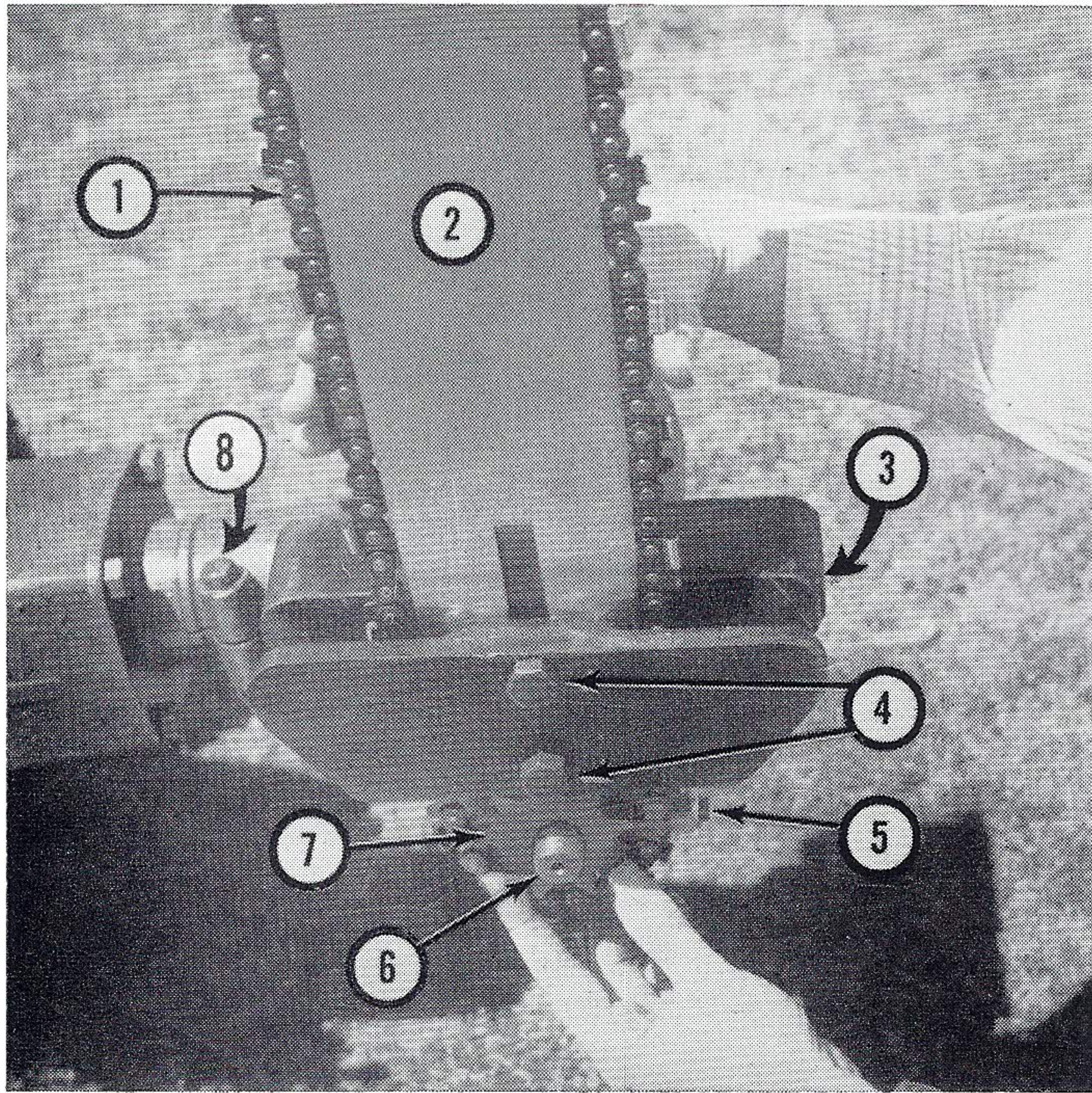

PLATE 22

(1) Chain, (2) Chain Blade, (3) Bracket, (4) Guide Bar Clamp Bolts, (5) Bracket Clamp Screw, (6) Attachment Drive Shaft, (7) Sprocket, (8) Angle Adjustment Bolt.

#### CHAIN SAW

##### ATTACHING

To attach Chain Saw Assembly to the drive, remove the large nut on the bottom of the Attachment Drive Shaft, and remove the three Collars.

Loosen the Bracket Clamp Bolt on the split end of the Bracket until it will slip onto the Housing from which the Attachment Drive Shaft projects. (It is sometimes necessary to wedge the split ends apart slightly.)

On Chain Saw Drives, Models 52 through 58, the Diameter of the housing is 2 $\frac{3}{4}$ ". These models take the Part Number CS-101 Chain Saw Bracket. On Models 58-A and 185, the Chain Saw Bracket part number is CS-101-1, and the diameter of the housing is 3 $\frac{1}{4}$ ". The bigger diameter chain saw bracket (CS-101-1) can be converted for use with the Models 52 through 58 of Rotary Mower Drive by the purchase of a Converting Collar, part number CS-331.

The lower edge of the Bracket should be lined up even with the lower edge of the **Housing**. (Not the fixed collar!) Then clamp the Bracket in place by tightening the Bracket Clamp Screw. (See Plate 22.)

Rotate the Bracket until the Guide Bar is pointing straight up. Tighten the Bracket Clamp Bolt until the Bracket stays in place.

Loosen the Guide Bar Adjusting Screw and Clamp bolts that hold the two sides of the Bracket together. The latter should be loosened only enough to allow the Guide Bar to slip back and forth easily.

Put the Chain on the Guide Bar, bring it through the Bracket.

Now, insert the  $\frac{1}{2}$  inch collar on the Shaft, with the COUNTER-BORED SIDE toward the BOTTOM of the shaft. Slip the Sprocket on the Shaft, put the Chain around it. (NOTE: The Sprocket revolves in a counter-clockwise direction when viewed from the end of the shaft on Models 58, 58-A, 185. On Models 52 through 57, the shaft revolves in the clockwise direction . . . the cutting edge of the Chain Teeth must move in the same direction.)

Then follow with the  $\frac{1}{4}$  inch Collar and the  $\frac{7}{8}$  inch Collar, with the COUNTER-BORED SIDES OF BOTH COLLARS TOWARD THE SPROCKET. Put on the flat washer, then the nut and tighten down firmly.

After adjusting and tensioning the Chain (See Adjusting and Tightening the Chain), Rotate Clamp to proper working position and tighten the bolt to hold it in place.

##### ADJUSTING AND TIGHTENING THE CHAIN

After you have the Chain in place, tighten up the Chain by means of the Chain Adjusting Screw. The proper tension of the Chain is very important. When properly tensioned, the Chain will be slightly loose on the Guide Bar, but not loose enough for the Driving Links to come out of the slots when the Chain is grasped firmly and pulled strongly away from the Guide Bar.

Care must be taken not to get the tension too tight, or you will "burn" the Guide Bar. (See Plate 20.)

##### ANGLE ADJUSTMENTS

To change the position of the Chain Saw in relation to the Housing on which the Bracket is mounted, loosen the Bracket Clamp Nut at the split part of the BRACKET. Then turn the Bracket and Chain Blade to the position desired, tighten the Clamp Nut to hold it in position.

To rotate the Drive Assembly, loosen the nut on the Boss on the Swivel Casting. This will loosen the Swivel. Rotate the Saw Assembly to the position desired, then tighten the nut tightly to hold the Saw in the desired position.

#### CHAIN SAW OPERATING INSTRUCTIONS

##### HOW TO SAW

Always swing the Saw SIDEWAYS into the tree if you are felling or notching.

**IMPORTANT:** Never feed the Saw into the wood by any method except **light hand pressure** at the handles. DO NOT lean against the handles, or brace your body in any way to feed the Saw into the work fast.

It is so easy to feed the Gravelly Chain Saw that the tendency is to force the Saw into the wood. If you do force the Saw, it will cause excessive wear of the Chain and Guide Bar, resulting in unsatisfactory operation and excessive maintenance cost. Therefore, **ease** the Saw into the tree slowly, letting it "feed itself" without forcing. **A properly sharpened and gauged Saw will feed itself into the work with almost no effort on your part.**

##### DEPTH GAUGE SETTING

One of the two "secrets" of successful Chain Saw operation is the proper setting of the "Depth Gauges." The Depth Gauges are projections that control the depth of bite of the



**Saw Chain.** These are NOT factory set, and must be filed down to correct depth before your Chain Saw will cut satisfactorily.

A "Gaugit" is furnished with each Chain Saw. Directions for its use are also furnished, and it is very important that these directions be studied and the simple and easy filing down of the Depth Gauges be done before you attempt operation of the Chain Saw.

#### SHARPENING THE SAW

A Chain Saw will cut well only if it is sharp. Your Gravely Dealer will furnish you with a sharpening set that makes correct sharpening of your Chain Saw fast and easy. The set is FREE, and is made so that filing of the correct angle of the Tooth is carried out automatically. A sharp Saw Chain is the second of the two "Secrets" of successful Chain Saw operation.

#### CAUTIONS

The Chain Saw is a specialized tool, and must have specialized care for best results. Special Instructions for proper maintenance and sharpening of the Chain Saw are packed with the equipment. **BE SURE TO READ AND FOLLOW THESE ILLUSTRATED DIRECTIONS.**

It is possible to cut timber flush with the ground when using the Gravely Chain Saw, and in many cases this is desirable. However, digging the Saw into the dirt means that the soil, mixed with the lubricating oil, forms an abrasive that soon wears the Saw Chain and the Guide Bar. **You can ruin a new Saw Chain and Guide Bar in a short time unless proper precautions are taken. This is true of ANY Chain Saw.**

We recommend that if you intend to saw much timber off even with the ground that you purchase the Circular Saw, which is inexpensive, and make a second cut at your leisure to get rid of the low stumps you may leave. The Circular Saw is used on the same drive as the Chain Saw.

Lubrication of the Saw Chain is very important. Lack of lubrication will "burn" the Guide Bar. (See Chain Saw Oiling System.)

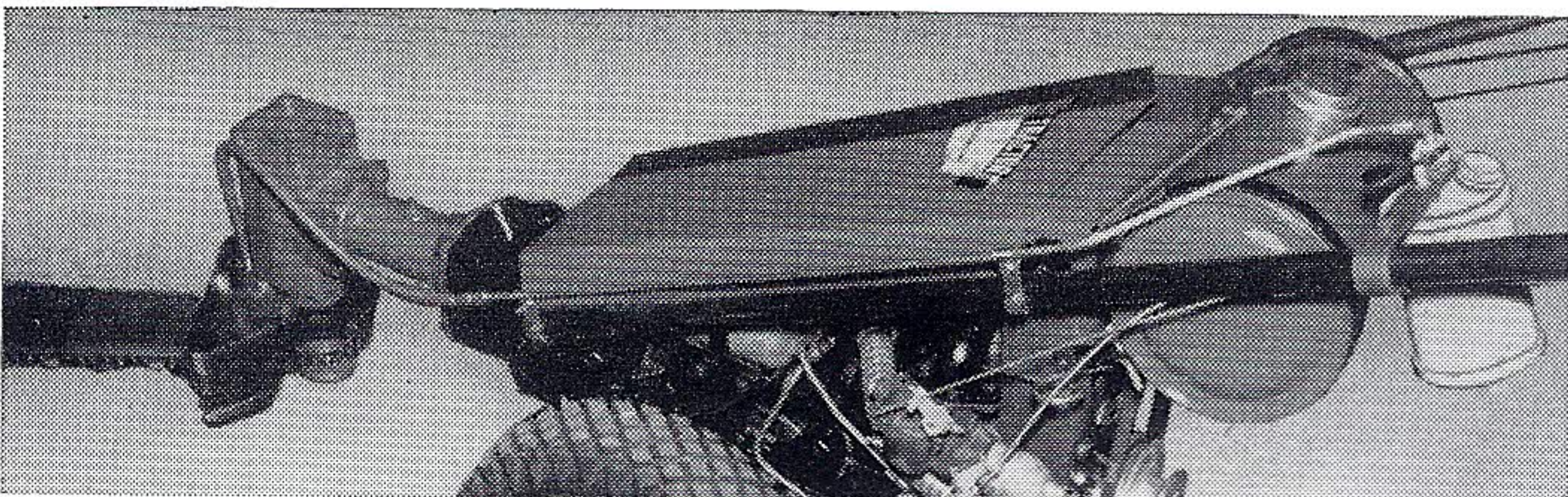

PLATE 23

#### CHAIN SAW OILING SYSTEM

The Chain Saw has a separate assembly which furnishes oil to the Chain by the operation of a thumb-plunger.

#### ATTACHING

First, install the Bracket on the Tractor Handle. Put in the Elbow Fitting, and attach the tubing as shown.

To install clips on Handle Bolts, simply loosen the bolts, insert the slotted end of the clips, and tighten the bolts.

Screw the male thread of the Flexible Tube into the Bracket of the Chain Saw. Then attach the other end of the Flexible Tube to the Oil Pipe with the straight Connector.

#### OPERATION

Depress the thumb lever on the Can. This supplies oil to the Chain. Use ordinary motor oil—new or used—as lubricant. The Chain should receive a liberal amount of oil during operation.

To disconnect, take the Flexible Tube loose from the Oil Pipe at the straight Connector. The Oil Tank and Oil Pipe may be left on the Tractor, or taken off, as you desire.

#### THE CIRCULAR SAW

The Circular Saw is useful for clearing land, and cutting down small trees. It has the big advantage of making short work of small scrub growth, saplings, sprouts, etc., cutting them off even with the ground. This allows you to mow over the area with your Gravely Sickle or Rotary Mower.

We do not recommend the Circular Saw for felling large trees. The Chain Saw will do this job faster and better.

#### ATTACHING

To attach the 18" Circular Saw Blade, put on the Collars and Blade IN THIS ORDER:  $\frac{7}{8}$  inch Collar,  $\frac{1}{2}$  inch Collar, the 18 inch Circular Saw Blade, then the  $\frac{1}{4}$  inch Collar. Put on the large nut and tighten down firmly.

Be sure that the Collars next to the Circular Saw Blade have the COUNTER-BORED sides FACING the Saw Blade.

The cutting edge of the Circular Saw tooth must face the direction of shaft rotation. See "Rotary Knife Mower" instructions to determine shaft rotation.

#### SAW GUARD

An optional Circular Saw Guard is available from your Dealer. To attach, fit the Split Ring to the Housing, swing the Guard to the position desired, and tighten down the two bolts and nuts. This will clamp the Guard in position. Give Model Number of Drive, to assure proper size.

#### USING THE CIRCULAR SAW

The Circular Saw is fed into the work from the side the same way as the Chain Saw, by pivoting the Tractor. Just exert pressure on the handle opposite the work, and keep a firm pressure against the work. Do not force the Saw into the tree . . . let it "eat" its way in gradually.

#### CLEARING LAND

The Circular Saw is most effective when used for land clearing operations. The method is to put the Saw in the horizontal position, and drive the tractor forward slowly. If you are working in very dense undergrowth, it is helpful to swing the Blade back and forth as you move slowly forward. This will let you cut a wide path. Your judgment will soon dictate when to stop the forward movement and concentrate on a sprout or sapling that is too large to "drive through."

Care should be taken not to run the Saw Blade into the ground, or against rocks. This will, of course, quickly dull the Saw and require sharpening and resetting.

#### SHARPENING THE SAW BLADE

We do not recommend field sharpening. Instead, you are better off to take the Saw Blade to a professional Circular Saw Blade sharpener, or to your Gravely Dealer. "Setting" the teeth requires special tools, and sharpening the Saw with the correct angle also requires special equipment.

#### STORAGE

If you are going to store your Circular Saw Blade for several days or longer, we recommend that you coat it heavily with Mobilgrease MP.

## LAWN ACCESSORIES



PLATE 24

#### STEERING SULKY

A Gravely Steering Sulky gives you an amazing new experience in easy, comfortable, efficient mowing.

You steer the tractor like a car by a steering wheel that gives you quick, accurate, effortless control!



Attaching instructions are under "Rear Hitch", page 23. Dual Wheels should always be used with the Steering Sulky.

## LUBRICATION

The only lubrication required is an occasional shot of Mobilgrease MP in the Alemite fittings.

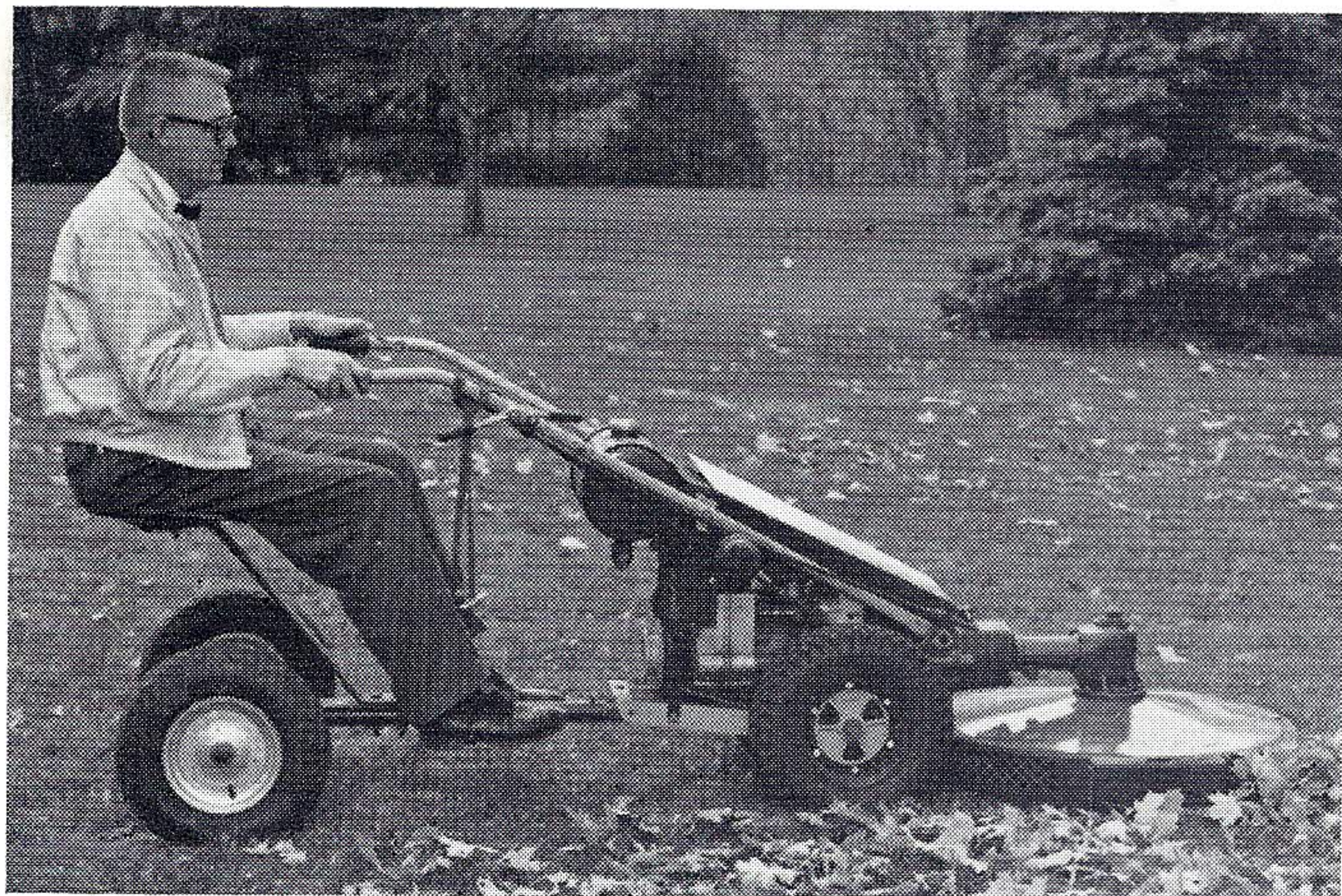

PLATE 25

## RIDING SULKY

A Gravely Riding Sulky allows you to mow comfortably while you ride. You can cover an amazing amount of ground in a little while with a Riding Sulky, and the Tractor is even easier to handle.

Handicapped persons often do a lot of their own mowing with the Sulky when otherwise it would often be out of the question.

The Sulky has a comfortable spring seat, pneumatic tires. It requires the Rear Hitch.

**ATTACHING:** See Rear Hitch, page 23.

### ADJUSTING THE SEAT

The Seat is attached to the Seat Spring by a bolt through one of the two holes in the Seat Spring. Adjustment is made by attaching the Seat to whichever Bolt Hole is most comfortable.

It is sometimes necessary to "level" the Tractor when using the Sulky on the Rear Hitch, to keep the Handles from interfering with your knees on turns. This is done in two ways:

First: To level the Tractor, loosen the Ball Stud Lock Nuts. To raise the handles, turn the Ball Stud clockwise. To lower the Handles, counter-clockwise. The bottom of the stud has an opening to fit a 1/4" Allen Wrench.

**AFTER ADJUSTMENT, TIGHTEN THE BALL STUD LOCK NUTS TIGHTLY AGAINST THE REAR HITCH FRAME.**

Second: If there is still interference, the Handles may be adjusted by loosening the Handle Bolts closest to the rear of the tractor, and moving the Handles upward or downward in the slots until they are at the proper height. Then tighten the Handle Bolts down **tightly**.

### LUBRICATION

The only lubrication required is an occasional shot of Mobilgrease MP in the Alemite fittings on the Wheel Discs.

## ROLLER

For a smooth, velvety lawn, you will need the Lawn Roller Attachment for the Gravely Tractor.

The Roller is 32" wide, has rounded edges to prevent injury to the lawn, and weighs 655 pounds when loaded.

The powerful Gravely easily handles the Roller and the operator, who rides comfortably on a spring seat.

**ATTACHING:** See Rear Hitch, page 23.

### FILLING THE ROLLER

The Roller is filled with water by removing the large Brass Plug found on the right-hand side as you look from behind the Roller toward the Tractor Handles.



PLATE 26

Of course, the Roller should be rolled until the Plug is at its highest point for the maximum weight. Have no hesitation about filling it as full as possible . . . the Tractor has plenty of power for the job. Be sure to replace the plug **TIGHTLY**.

### LUBRICATION

The only lubrication required is an occasional greasing of the Axles. Just remove the Cotter Pin, slip off the large washer and put a generous amount of Mobilgrease MP around the Axle, put back the washer and cotter pin.

## WEED MOWING EQUIPMENT

### SICKLE MOWER

The Gravely Sickle Mower Attachment is a rugged, dependable mower that makes the toughest weed and brush mowing jobs easy. It will mow anything that will go between

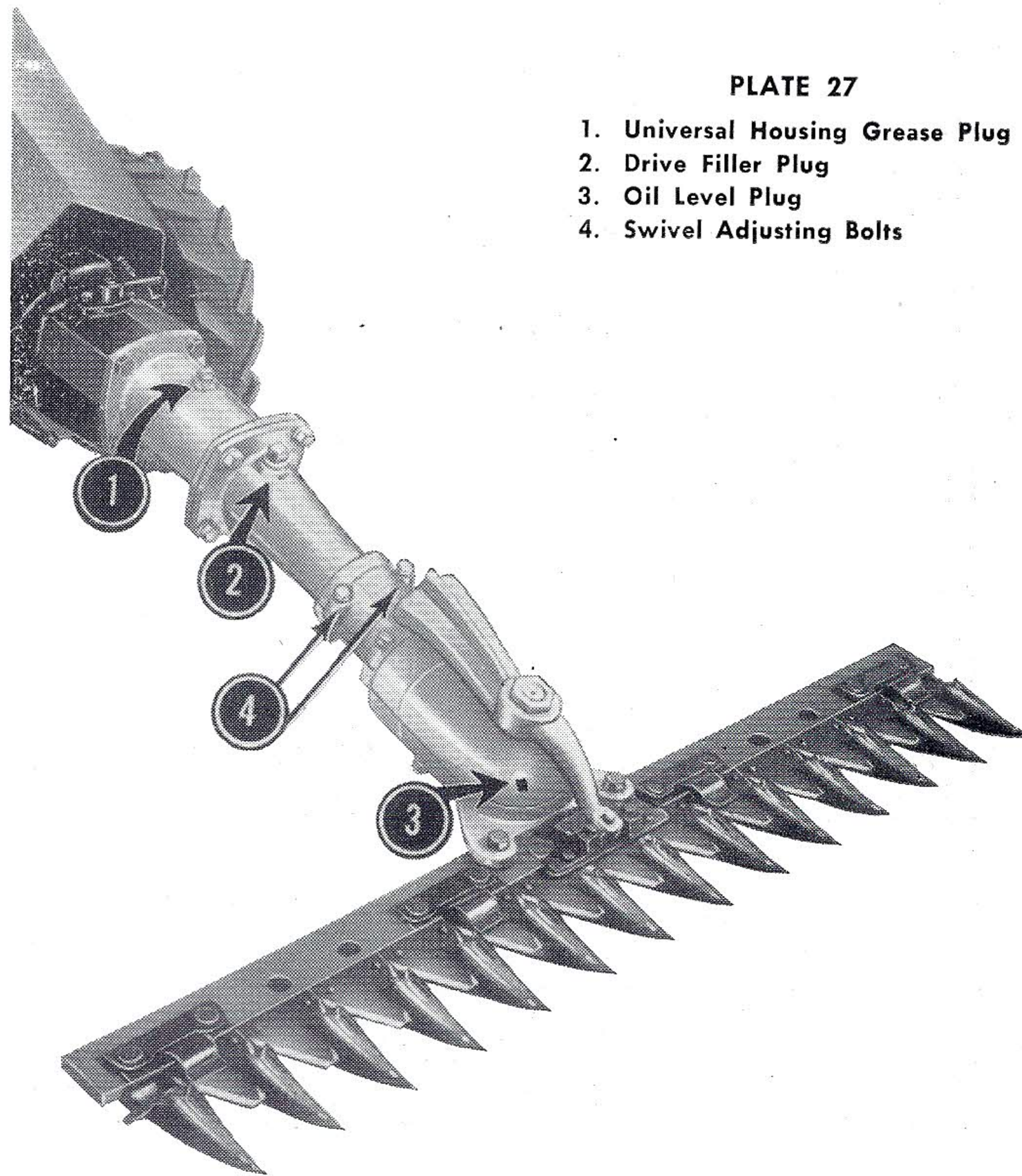

PLATE 27

1. Universal Housing Grease Plug
2. Drive Filler Plug
3. Oil Level Plug
4. Swivel Adjusting Bolts

the Guards. Swivel Action allows the blade to follow the ground contour for a clean cut, and it is Safety Clutch protected again damage.

The Sickle Mower is furnished with a 42 inch Blade. Longer blades are available from your Dealer for special purposes. The Blades are furnished with three-inch sections for heavy mowing. For fine mowing, two-inch Sections are available.



### ATTACHING

The Sickle Mower is attached by four bolts to the front of the Tractor, like all other power attachments.

### LUBRICATION

You will find three Oil Plugs on the Sickle Mower Drive Column. See Plate 27. The Oil Plug on the Column section closest to the Tractor lubricates the Universal. Remove the plug and fill about half full of Mobilgrease MP.

Sometimes, since this Universal Joint needs attention only occasionally, it is more convenient to remove the Safety Clutch, take out the four bolts that hold the lower Column to the Universal Housing, and slip the Housing partly off. Then you can put a generous application of Mobilgrease MP directly on the Universal Joint, covering it all over with about an inch or inch and a half coating of the Grease. Re-assemble the parts, being sure to tighten firmly the large nut that holds the Safety Clutch.

You will find two Oil Plugs on the Crank Housing section next to the Blade. The smallest is the Oil Level Plug. To check the oil, remove this plug while the attachment is on the Tractor. If oil runs out, you have enough. If it doesn't, remove the large Oil Plug on the column directly above the Crank Housing and fill until oil runs out the Oil Level Plug hole. Use MOBILLUBE GX-140. **Do not continue to add oil after the oil starts to flow from the Oil Level hole.**

When you fill this part of the Sickle Mower for the first time, or after draining old oil, it will take one-half pint.

Be sure to replace ALL plugs before using the Sickle Mower.

### LUBRICATING KNIFE AND BLADE

While the Sickle Mower is working, juices from weeds and grass will furnish sufficient lubrication. However, the Knife and Bar will rust when not in use.

To prevent this rusting, wipe the Knife and Bar with a cloth moistened with light oil. Put on a thin coating.

If you are going to store the Sickle Mower for any length of time, we recommend careful cleaning and an application of Mobilgrease MP to all unpainted parts.

### ADJUSTING THE CLIPS

The Clips that hold the Knife to the Bar should be checked and adjusted frequently. If these clips are not adjusted properly, grass will foul between the Knife and Guards and cause "bunching" or piling up of the grass and inadequate feed-off. Also, fine grass will not be cut because the Knives will give enough so that the grass is knocked into the space between the Knives and the Guards instead of being sheared cleanly.

The Clips should be adjusted closely enough to hold the Knives in firm contact with the Shear Plates on the Guards, but not tightly enough to bind. The knife should slide back and forth easily with the pressure of a finger and thumb.

The usual method is to knock down the Clips gradually with taps from a light hammer.

If your mower has seen quite a bit of use, the iron in the Clips may have "crystallized" slightly. This does not affect operation, but a sudden sharp blow from a hammer may crack or break the Clip. So tap the Clips down **lightly** and firmly.

### KEEP THOSE BOLTS TIGHT

Any Sickle Mower, since it has a very fast change of lateral direction taking place every few seconds, is subject to some vibration. The Gravely Sickle Mower is built and balanced carefully, and although vibration is held to a minimum, it is not eliminated.

For this reason, in certain critical places, special bolts with a high thread count to the inch are used, and special locking nuts.

But in spite of these engineering precautions, the vibration will loosen bolts and nuts after so long. Therefore, it is wise to periodically check and tighten the bolts and nuts on the Attachment. You should check before you start a job, and in very heavy cutting, we recommend that the bolts and nuts be checked frequently and retightened if necessary.

### CARE OF THE KNIVES

A sharp Sickle is the first requirement of any mowing job for satisfactory results. A gapped, dull Sickle Knife will chew through coarse weeds and brush, but you will run into trouble in fine grass, and not get a clean cut.

Sharpen your knife often. In fact, it is best to have an extra Knife around, sharpened, so you can change quickly if you are caught in the middle of a mowing job. That way you can keep a sharp Knife on your Sickle Mower, and have a sharp Knife in reserve at all times.

To remove the Knife for sharpening, remove the Knife Bracket Screws and slip the blade out either side. **WHEN YOU REPLACE THE BLADE, ALWAYS BE SURE THESE SCREWS ARE TIGHT.**

The Knife Sections should be ground at the same angle they were originally. It is usually fairly easy to follow this angle. Your Dealer has a hand Sickle Grinder that has a special grinding cone the right pitch for grinding the Knives or for a small charge he will sharpen your Knives for you.

### ADJUSTING THE SWIVEL ACTION

A very important feature of the Gravely Sickle Mower is the swivel action of the Cutter Bar. This swivel action is adjusted by means of the two bolts on the upper (towards the tractor) part of the Crank Housing.

When these bolts are tight, the Bar is held rigid. When they are loosened, the Bar will swivel and follow the contour of the ground.

The bolts should be adjusted tight enough so that the Bar will hold its position until lowered, and loose enough so the Bar will tilt according to the slope or contour of the ground.

### ADJUSTING THE GUARDS

The Guards should always be kept in alignment. If one Guard gets bent up and another down, it will not cut fine grass. Use a light hammer and knock the Guards up or down until the Knives on the Sickle lie flat on the Shearing Plate of the Guards.

Always keep the Guard Bolts drawn up tight.

### TROUBLE SHOOTING

#### 1. Losing bolts and nuts.

Tighten bolts and nuts periodically.

Most people who lose bolts and nuts from the Sickle Mower are trying to mow in high gear at a fast speed. Excessive speed will exaggerate the vibration, and cause bolts and nuts to loosen much faster than normal. Always mow at a normal walking speed **in low gear.**

#### 2. Bunching or piling of cut grass or weeds on the Blade . . . also called improper feed-off of cut material.

There are several reasons for this—it may be one, or a combination. First of all, check Guard alignment, Knife alignment, and the sharpness of the Knife. Correct any of these conditions that are not right.

The usual cause is excessive mowing speed. It is important enough to repeat . . . always mow at a normal walking speed.

Another cause is letting one end of the Sickle Mower drag up already cut material. In normal operation, there is a three or four inch space next to uncut material during a cut. But if you take a smaller "bite" of uncut material and let one end of the Bar gather up cut material it will bind the Knife, and drag the material you are cutting so it will pile up.

Another cause that is often a contributing factor is letting your Mower get rusty and gummy. This increases the friction on the cut material. Always keep the Bar clean of gum and rust.

The Safety Clutch may not be adjusted properly. In this case it will hesitate during a cut, and the forward speed of the Tractor will cause uncut material to be pulled loose and rammed in the Knives. Uncut material will also jam the Knives unless they are sharp, especially in fine grass. See "Adjusting Safety Clutch."

#### 3. Excessive vibration.

Usual cause is that the Wearing Tip on the end of the Actuating Lever is badly worn, or perhaps even lost. Or it may be loose due to neglect of keeping the Wearing Tip tightly bolted to the Actuating Lever. A badly worn bracket will also contribute to excessive vibration. Or, again, you may be trying to mow too fast, and running the mower at high speed.

### SKIDS

Skids which fit under the Cutter Bar and raise it off the ground are available at your Gravely Dealers. For most



of your work, they will not be necessary. But they are handy for pasture mowing, where you want to cut weeds out and let the grass grow, and for a few other purposes.

If you use four Skids, they are put directly under the first and fifth Guard from either end. The Guard Bolts are moved and the Skid Bolts put in the vacant holes, using the same Guard Nuts. Adjusting spacers are furnished with each Skid, and with these you can regulate the height of cut. We do not recommend the use of only two skids.

### CAUTIONS

The Sickle Mower Knives are sharp. Never reach down to clear the Mower, or do any adjusting whatsoever near the Sickle Bar, unless the attachment is out of gear, and the Tractor Engine stopped. Never handle the attachment by the Guards . . . if you must move it, grasp it by the Column and one end of the Sickle Bar. Never put your fingers between the Guards when moving the attachment!

Try to keep out of wire, rocks, tin cans, etc. The Slip Clutch will protect your attachment and your Tractor, but these will cause minor nicks in the Knives, which will cut down on your mowing efficiency.

Remember to mow at a normal walking speed.

### MOWING SLOPES

You can mow a 60% slope with a Gravely Tractor and Sickle Mower Attachment, when using Dual Wheels or Extension Axles.

## WEED MOWING ACCESSORIES

### EXTENSION AXLES

Extension Axles are used to give a lower center of gravity, and make working on steep slopes easy and efficient.

They serve about the same purpose as Dual Wheels. On some jobs, where **very** steep slopes are mowed (for example, levees, railway embankments, etc.), the Extension Axles and Dual Wheels both may be used with a special length Cutter Bar on the Sickle Mower. Equipped this way, the Tractor will mow anywhere a man can walk. The chief advantage of the dual wheels as compared with the Extension Axles is that with the Dual Wheels you have double the amount of driving surface in contact with the ground.

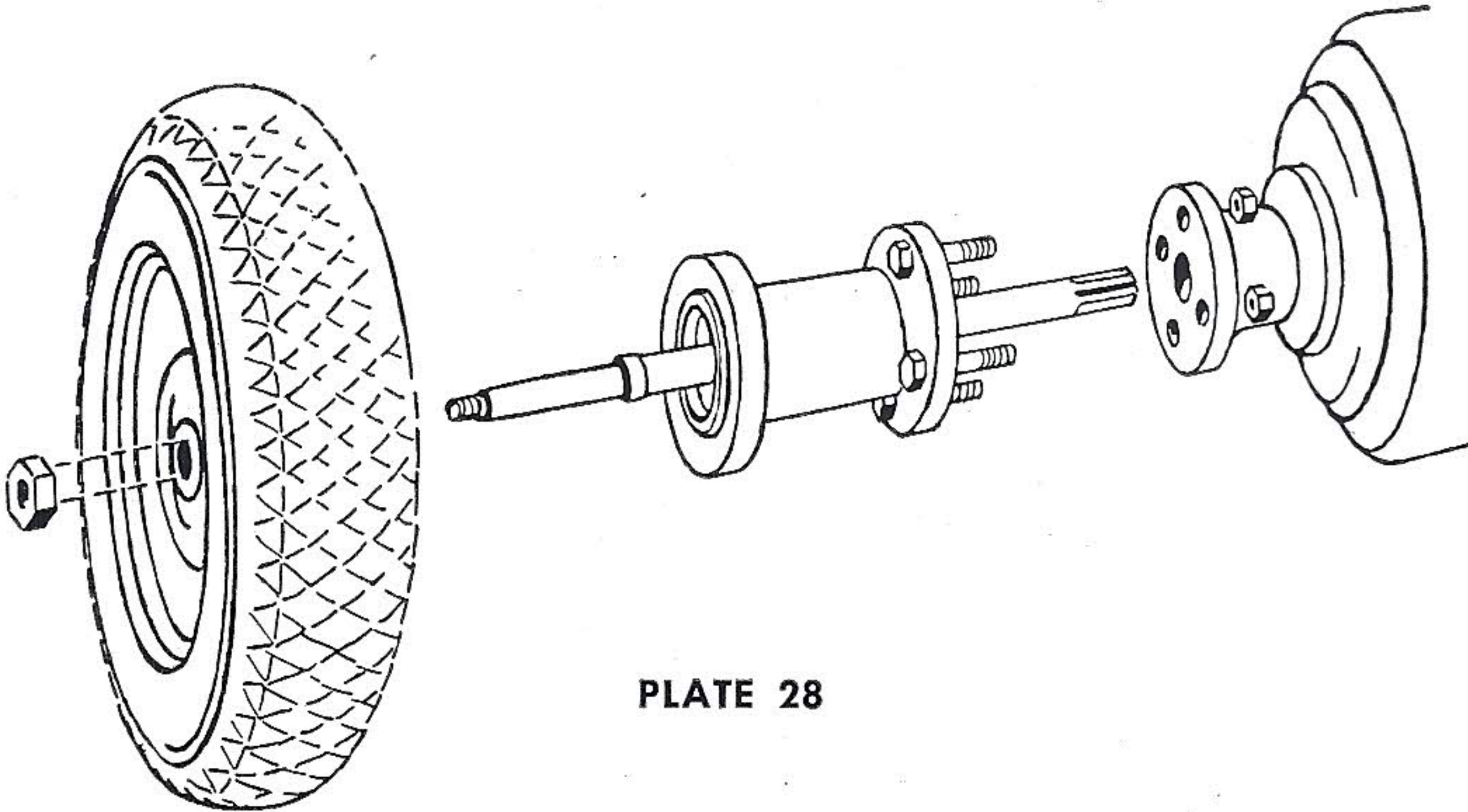

PLATE 28

### ATTACHING

Remove the Hub Cap from the Tractor Wheel. Remove the large elastic stop nut that holds the Wheel.

Block up Tractor so Wheels are free of the ground.

If you have a Wheel Kicker, screw it on the Axle and tap with a hammer until the Wheel "breaks loose" from the tapered Axles. Then take off the Wheel.

If you do not have a Wheel Kicker, insert a tapered punch or wedge **BETWEEN** the Axle Housing and Wheel Hub and drive down gradually, wedging the Wheel loose from the tapered Axles.

Remove the four cap screws from the Cap, and take off the Cap and Oil Seal. The Axles will now slide out easily.

Insert the Splined Axle of the Extension Axle in place of the short Axle, lining up the Splines with the Gears inside the Tractor by turning gradually until they slip into place.

Now insert the screws through the holes in the Extension Axle and the Tractor Axle Housing, put on the nuts and draw tight.

Replace the Wheel and Wheel Nut.

Store your Short Axle for future use, first coating it thoroughly with Mobilgrease MP.

### LUBRICATION

None required.

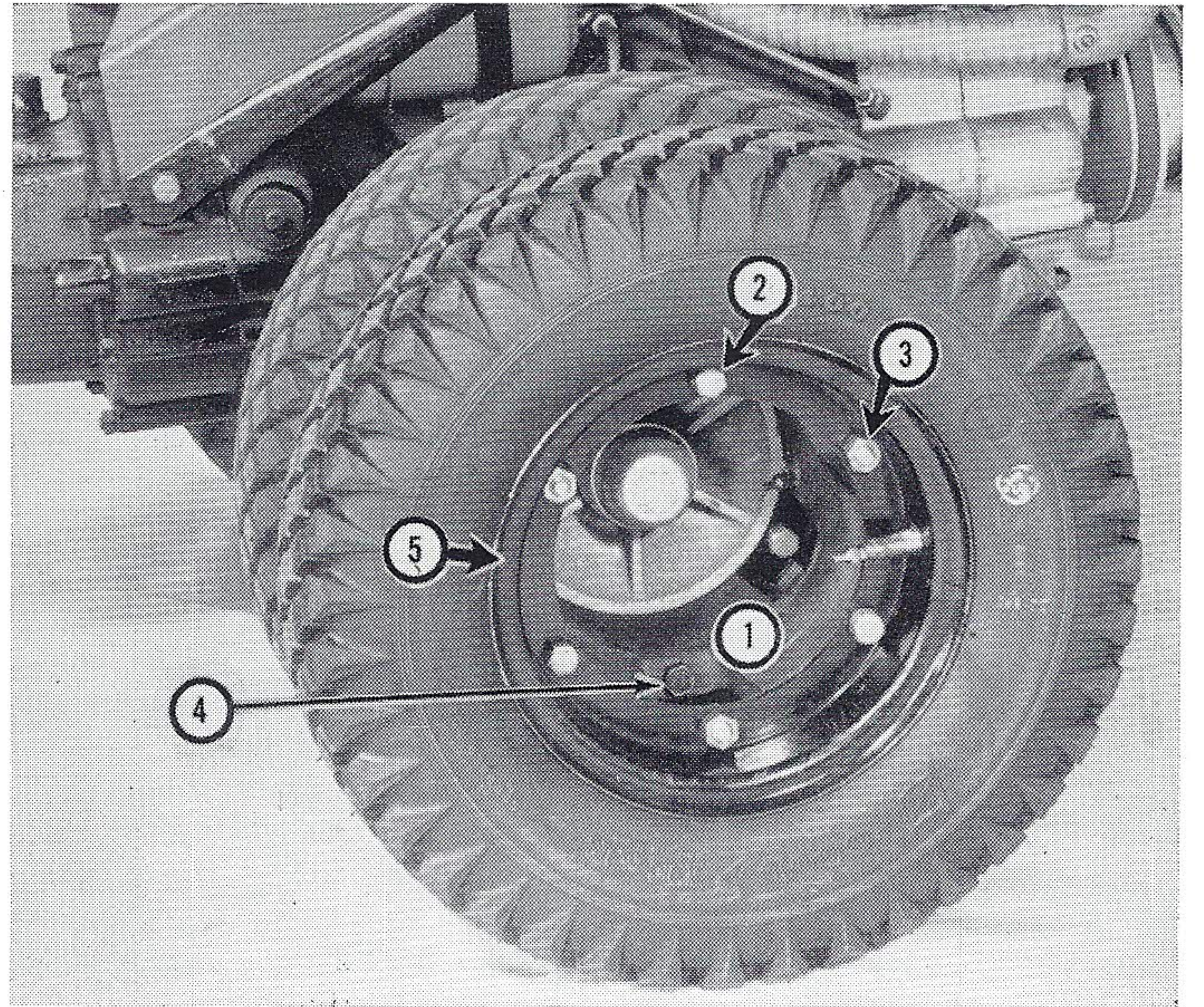

PLATE 29

1. Dual Wheel Spacer
2. Rim Securing Bolt
3. Rim Securing Nut

4. Spacer Securing Bolt
5. Wheel Rim

### DUAL WHEELS

Dual Wheels will increase the usefulness of your Tractor, especially if you have any mowing to do on steep slopes. The Dual Wheels will allow you to mow on a 60% slope without difficulty!

They are useful wherever you need traction—for example, in using the Bulldozer Blade, mowing terraces and slopes with either the Rotary Knife, Sickle or Reel Mowers, and when you want to haul very heavy loads on the Hauling Cart.

### ATTACHING

Remove every other one of the screws that hold the Wheel Rim to the Tractor.

Use the long screws furnished with the Dual Wheel Spacer, inserting them in the recessed or cut-out parts of the Spacer. Attach the Spacer to the wheel by these long screws. (Be sure tire valve is in a recess.)

Take out every other screw in the Wheel Rim of the second Tire, line up the holes with the holes in the Spacer, insert the screws and tighten down.

### LUBRICATION

None required.

## GARDENING EQUIPMENT

### ROTARY PLOW ATTACHMENT

The Rotary Plow is a unique attachment. It gives you a deep, even seedbed in one operation. It is easy to handle. It will work new ground. It is **power-driven**—does not depend upon traction to operate!

### ATTACHING DRIVE

The Rotary Plow attaches to the front of the tractor by four bolts. The Angle Adjusting Bracket must also be attached by two of the four attaching Bolts.

### LUBRICATION

The Oil Plug is on top of the Gear Housing. Fill with about one and one-half **pints** of Mobilube GX-140. When it is necessary to replace oil, always drain out the old oil (by taking the Angle Adjustment Bolt loose, on the tractor, and turning the attachment upside down) and replace with new.



The Swivel Casting should be given an occasional shot of MOBILGREASE MP as needed, by means of the Alemite fitting. (See Plate 30.)

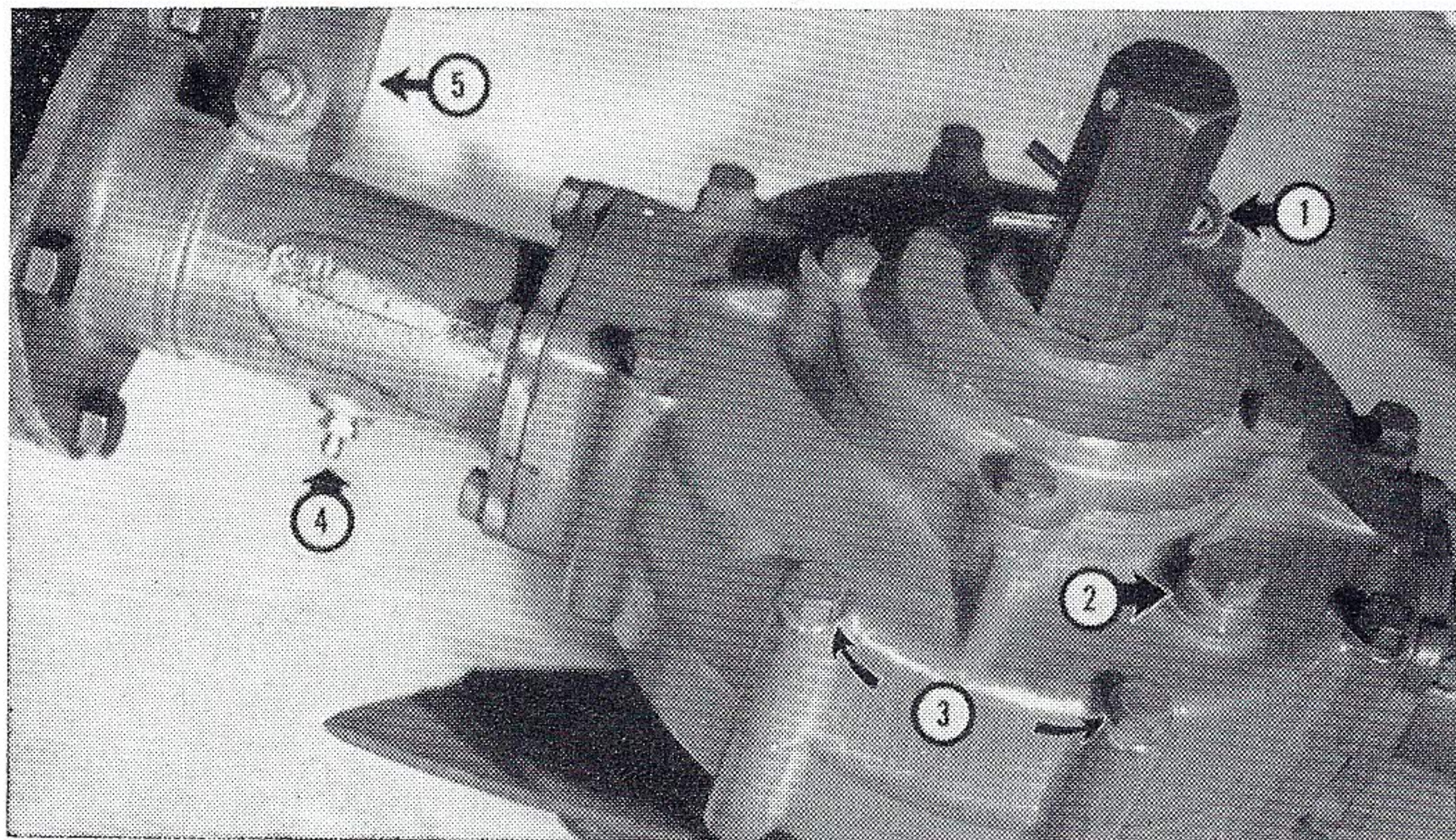

PLATE 30

(1) Depth Adjusting Clip, (2) Oil Filler Plug, (3) Attach Dirt Shield by these bolts, (4) Swivel Alemite Fitting, (5) Angle Adjusting Handle.

#### ADJUSTING DEPTH OF CUT

The large Pin or Clip in the Hex Shaft is the first depth adjustment. The higher up on the shaft you insert the pin, the farther down will go the blades and the deeper the furrow will be. The lower you insert the Pin, the higher the blades and the shallower the furrow.

Ordinarily the Pin is inserted in the top hole for plowing. For transporting, it is placed in the last hole at the bottom.

The final depth adjustment (if required) is made by sliding the Wheel Bracket Clamp Screw up or down on the slotted Wheel Bracket. The lower you set the clamp screw, the deeper you will plow.

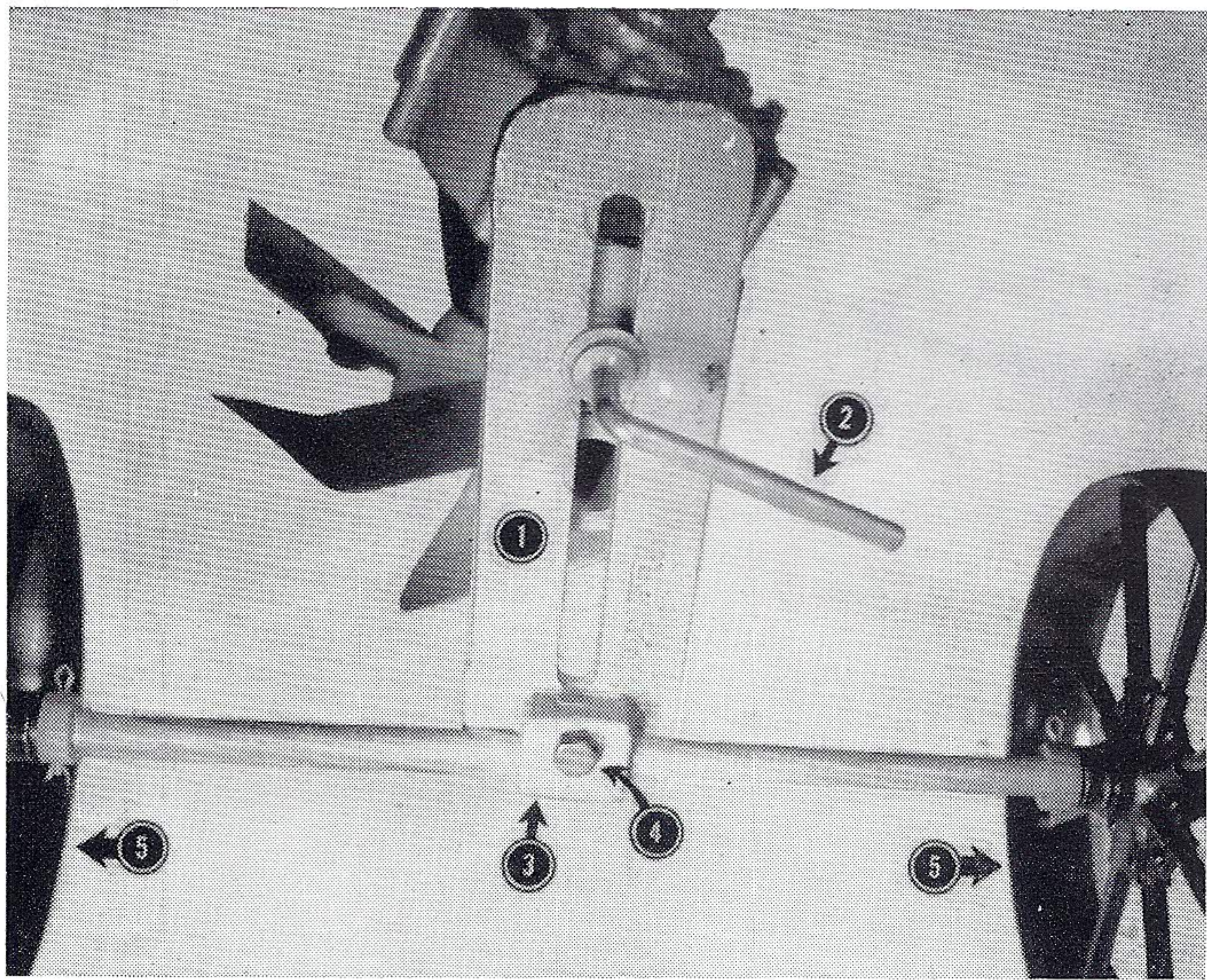

PLATE 31

(1) Wheel Bracket, (2) Wheel Bracket Clamp, (3) Axle Clamp, (4) Axle Clamp Screw, (5) Depth Wheel.

#### ADJUSTING WIDTH OF CUT

The width of cut is governed by the position of the Wheel Bracket in relation to the Depth Wheel that rides in the furrow. The closer the Wheel Bracket is to the Depth Wheel in the furrow, the narrower the cut. The farther away, the wider the cut.

#### ADJUSTING PLOWING ANGLE

**Proper angle adjustment of the Rotary Plow makes the difference between easy and difficult operation. The plow must be adjusted to your soil conditions, and this adjustment is made by increasing or decreasing the angle adjustment.**

When you plow for the first time, the best way to proceed is to set the angle adjustment at half-way in the slot. Be sure it is tight so it will hold. Then try a furrow or two.

If there seems to be an excessive side drag to the left, **increase the angle towards the horizontal.**

If the side drag is to the right, **decrease the angle towards the horizontal.**

To increase or decrease the plow angle, loosen the nut on the Adjusting Bolt, and move the Adjusting Handle up or down, retightening firmly.

A few experiments and you will have your plow adjusted to the soil. Then plowing is simply walking behind your tractor while it does the work!

#### DIRT SHIELD

The Dirt Shield for the Rotary Plow is optional at no extra charge. This flat metal shield attaches to the top of the Rotary Plow Housing by removing two of the bolts, inserting them through the two metal brackets, and replacing.

The Dirt Shield is used to direct the "throw" of the dirt. By bending it up or down, you can scatter or concentrate the dirt thrown by the blades, and put it right where you want it.

#### PLOWING YOUR LAND

To plow your land, first run a furrow down the center of the land to be plowed. Then turn the tractor at the end of the furrow by pivoting it, so the right hand Depth Wheel

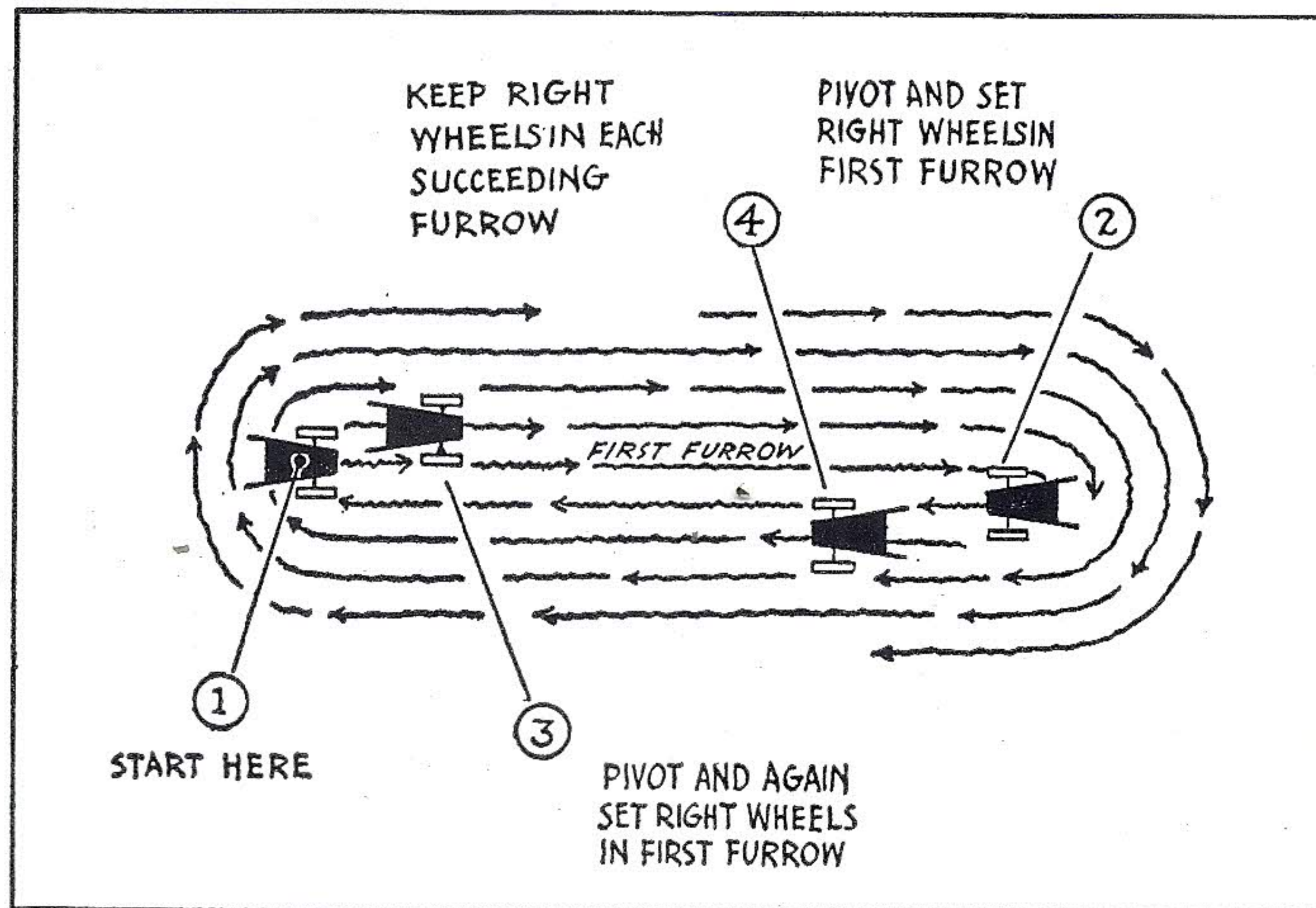

PLATE 32

is in the furrow you have just made. Continue this way so that dirt is always thrown to the center, turning at the end of each furrow, dropping the right wheels of the Tractor and Depth Wheels into the furrow until your plowing is completed.

If you are plowing a large area, you will soon be able to "pull" the tractor around the corners without pivoting. On a small area, it will be necessary to pivot each time.

This pivoting can be hard work unless you know this little trick. When you are ready to turn, bear down on the handles until the tractor is balanced. "Slip" your clutch gently, holding back slightly on the right handle. The transmission will pull the tractor right around without much effort on your part. A little practice will soon make you adept at this maneuver, and will make your plowing still easier.

Plowing is much easier if you can keep the Rotary Plow Housing level with the ground when the unit is in the furrow and plowing. To do this, try to get your DEPTH adjustment by use of the Hex Shaft holes, and adjust the horizontal level of the Attachment by means of the Axle Clamp Screw.

#### PLOWING WITH STANDARD OR GEAR REDUCTION WHEELS

Gear Reduction Wheels slow the forward speed of the tractor, but allow the attachment speed to remain the same. This means that even the toughest soil can be plowed easily with the Gravelly Rotary Plow.

However, many soils are plowed satisfactorily with standard wheels. **Occasional** jobs of plowing in very tough soil, sod, etc., can be handled by making two plowing cuts . . . one down to about three inches, then a second plowing getting the full depth desired.



Also, the use of chains for standard wheels seems to meet the requirements of some of our users.

Experiment, and consult your dealer. He will be glad to help you decide, and will demonstrate the Gear Reduction Wheels at no obligation, at your request.

#### OTHER USES

Your Rotary Plow can be useful for a number of different tasks that you won't suspect until you become used to it. The following are a few uses that our Users have told us about, which you may find helpful.

1. **DITCHING** . . . The Rotary Plow, especially when equipped with a special long Hex Shaft (available at your Dealer's) will do a very creditable job of ditching. The procedure is the same as in plowing, except normally only one pass is required in plowing. In ditching, make one cut fairly shallow. Drop the plow further, and make the second cut, and continue until the depth limit of the shaft and adjustments are reached. Do not drop the wheels into the furrow when ditching, but "straddle" the cut. A fairly heavy angle will also help, by throwing the dirt neatly out of the ditch for you.

2. **PLANTING TREES AND SHRUBS:** If you have several small trees and shrubs to plant, remove the Depth Wheels and Adjusting Bracket from the front end of the Rotary Plow Attachment. Then take the Adjusting Handle loose from the Adjusting Bracket. Turn the plow until the shaft is vertical.

Then put the attachment in gear, spot it in the place you wish to make your hole, and let the plow eat its way down. It will prepare a hole just about right for evergreens, small shrubs and trees.

3. **MAKING HILLS:** When planting Sweet Potatoes and other crops that require hills, it is easy to make the hills at the same time you plow.

The method is to start plowing right down the center of the space you want the hill. Continue as in regular plowing until you have the hill the right width. Then move over to the center of where you want the next hill, repeat the process and so on until all the ground is prepared.

#### GEAR REDUCTION WHEELS

Gear Reduction Wheels are indispensable when you are plowing very hard ground, sod land, or Gumbo with the Rotary Plow. They are also very useful when used with the Snowblower, and in some cases either of the Saws. They **must** be used with the Turn Plow.

The Gear Reduction Wheels slow down the forward speed of the Tractor about half, **but the attachment speed remains the same.**

This means a much better job of plowing, for example, because the Plow Blades strike the ground twice as many times per foot traveled.

#### ATTACHING

Remove the Hub Cap of the Tractor Wheel. Unscrew the elastic stop nut.

Block up the Tractor so the Wheels are at least 6 inches from the ground.

If you have a Wheel Knocker, screw it on the Axle and tap with a hammer until the Wheel "breaks loose" from the tapered Axles. Then take off the Wheel.

If you do not have a Wheel Knocker, insert a tapered punch or wedge **BETWEEN** the Axle Housing and Wheel Hub and drive down gradually, wedging the Wheel loose from the tapered Axles.

Put the Pinion Gear on the Tractor Axle, with key in place.

Pack inside of the wheel with a pound or pound and a half of Mobilgrease MP.

Slip the Wheel over the Pinion, matching the four holes in the Axle Housing with those in the Geared Wheel.

The Wheel will only go on with the short stub fitting into one of the 1/2 moon cutouts on the Axle Housing rim.

Insert the four bolts and tighten down good and tight.

The Wheel should carry between 20 and 25 pounds of air, if using Rubber Tired Gear Reduction Wheels.

Height adjustment is made by removing bolts in axle housing, rotating housing, re-inserting bolts.

Note: Bottom bolt is drainplug—See "Oil Change," page 2.

## ROTARY CULTIVATOR

The Gravely Rotary Cultivator attaches to the Gravely Rotary Plow Drive, to form a power cultivator that tills and aerates the soil, giving you power cultivation. It is particularly useful in Strawberry cultivation, and does an excellent job in the garden.

It is not a deep tiller. The Gravely Rotary Cultivator and Rotary Plow are the gardening twins—using the same attachment drive, you plow and power cultivate . . . do the complete gardening job with power!

#### ASSEMBLY

The unit consists of Hood, Drive, Tines.

To assemble Hood, fasten end plates to hood by bolts, washers and nuts provided. Note that a washer is used both under the head of the bolt and under the nut.

Assemble Tines to Shafts as follows. Place Cultivator Unit on a suitable surface, with the Oil Filler Plug and Oil Level Plug side of the Drive Housing facing you, the top of the Drive up (or away) from you. See Plate 33 for the correct way to assemble the **RIGHT HAND** Tines onto the shaft. Two sets, assembled as shown, will go on the right side, two on the left. Note that the cutting edges, if the shafts were revolved **TOWARD** you, would cut in the same direction as the shaft is being revolved.

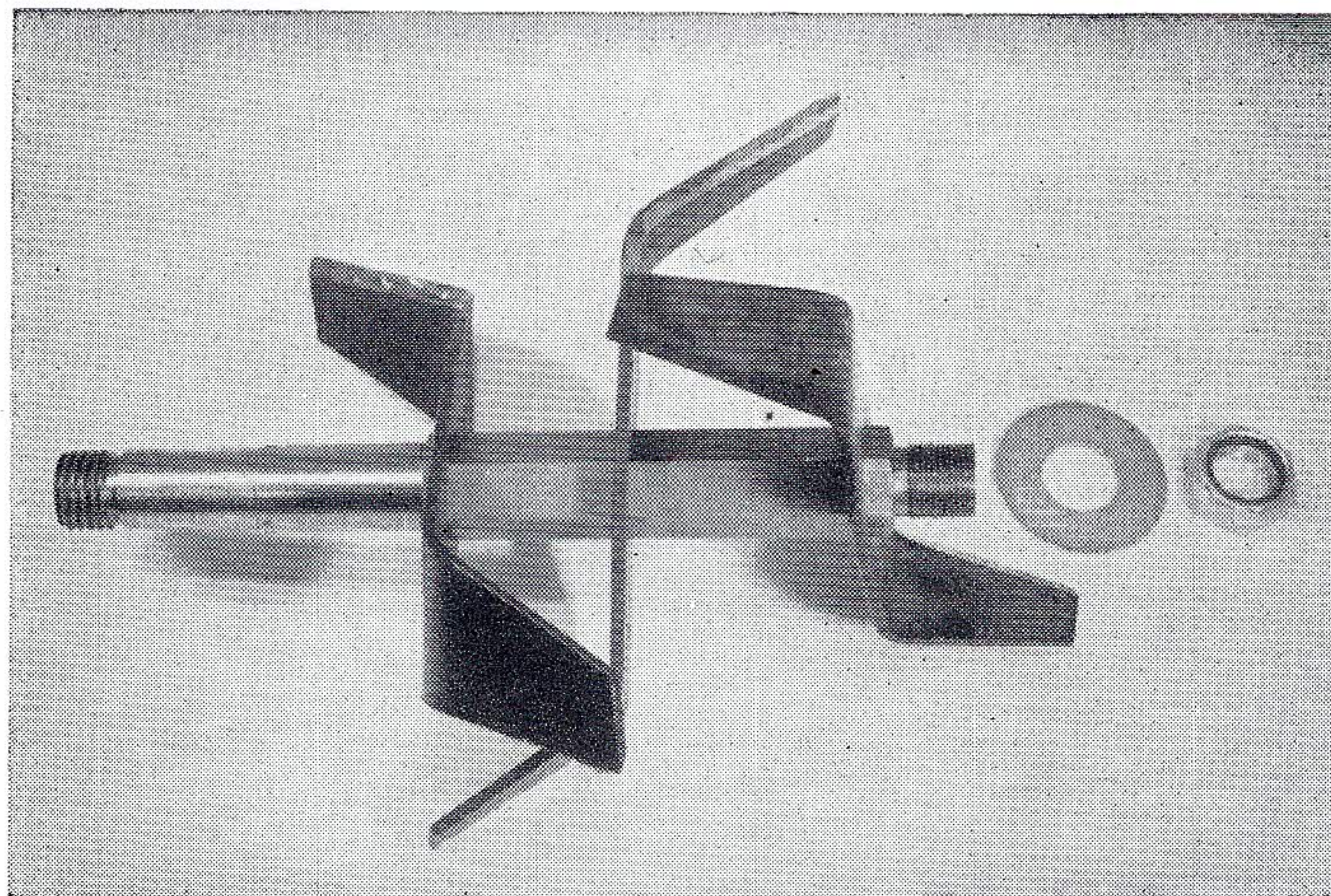

PLATE 33

To assemble the Tines to the Left Hand Shaft, assemble in the same way, but put them on the shaft from right to left. Correctly assembled, they will appear as in Plate 36.

Fasten by using the narrow spacer (Part No. RC-114), the large washer (Part No. 412-W) and the Elastic Stop Nut (Part No. 225-N).

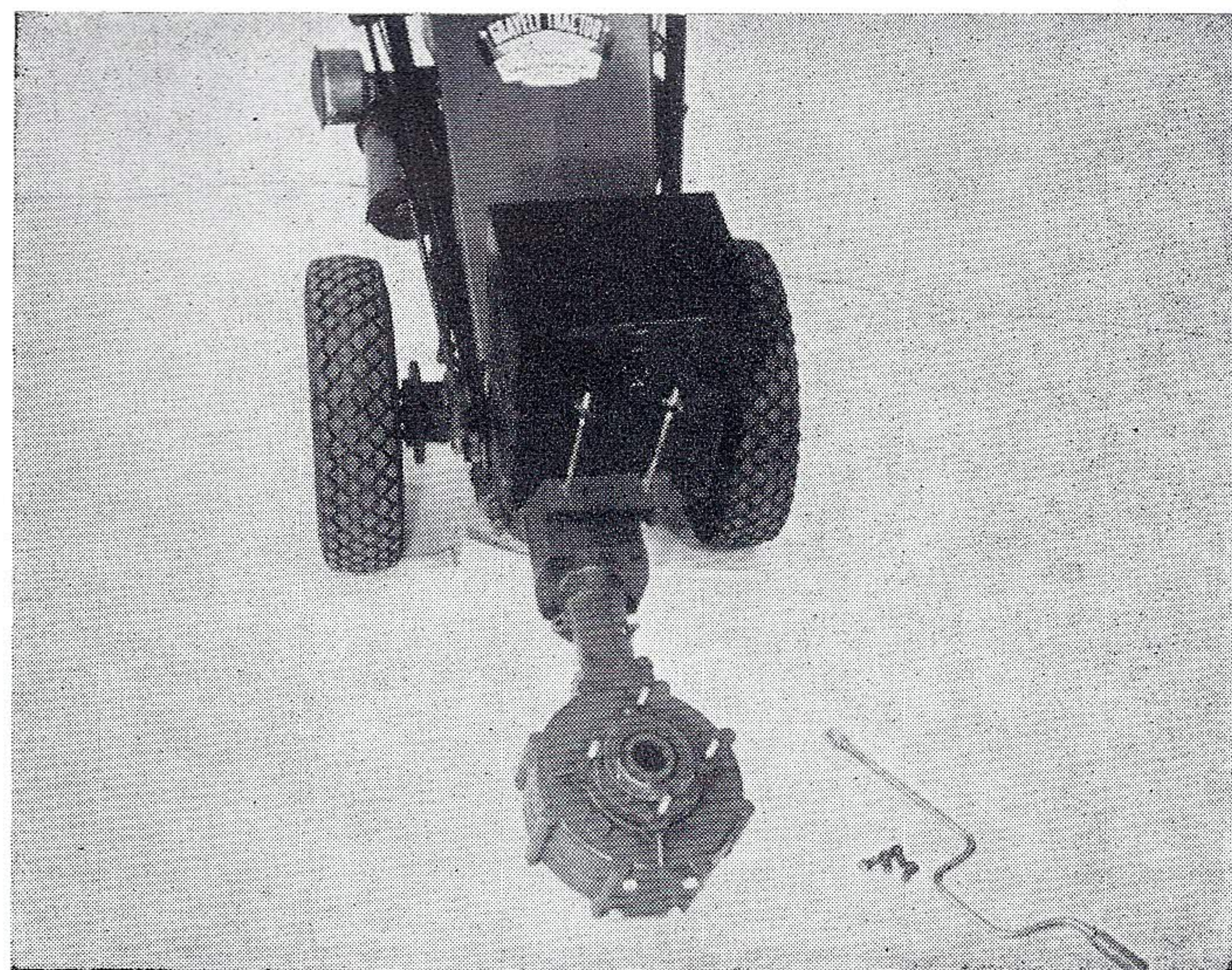

PLATE 34



## PREPARING THE ROTARY PLOW

The first step in preparing the Rotary Plow to receive the Rotary Cultivator is to remove the Adjusting Handle Assembly completely from the Rotary Plow.

Remove the Rotor Shaft, Spider and Rotor Spade Cutter assembly.

(The Depth Wheels, Bracket, and Column Assembly may be removed. They serve no useful purpose in the operation of the Rotary Cultivator, unless it is your desire to operate the Unit with the Tines "cutting against" the motion of the tractor. See operating instructions.) To remove this assembly, remove the four bolts from the front of the Rotary Plow Gear Housing, and remove the assembly. Reinsert the bolts to prevent oil leakage. **WARNING. The bolts as used on the Rotary Plow will lock the Rotary Plow Gear if tightened down tightly. We recommend the use of either short bolts, or of Bolts held away from the housing by washers the distance normally taken up by the Column Assembly.**

Turn the Housing through 180°. In this position it will appear as in Plate 34. Note the position of the Alemite Fitting and the Adjusting Handle Boss on the Column.

Remove the four bolts in the Bottom Cap, and insert the studs furnished. (If you do not have a stud driver, two nuts may be locked together on the threads and used to seat the studs firmly, then the nuts removed.)

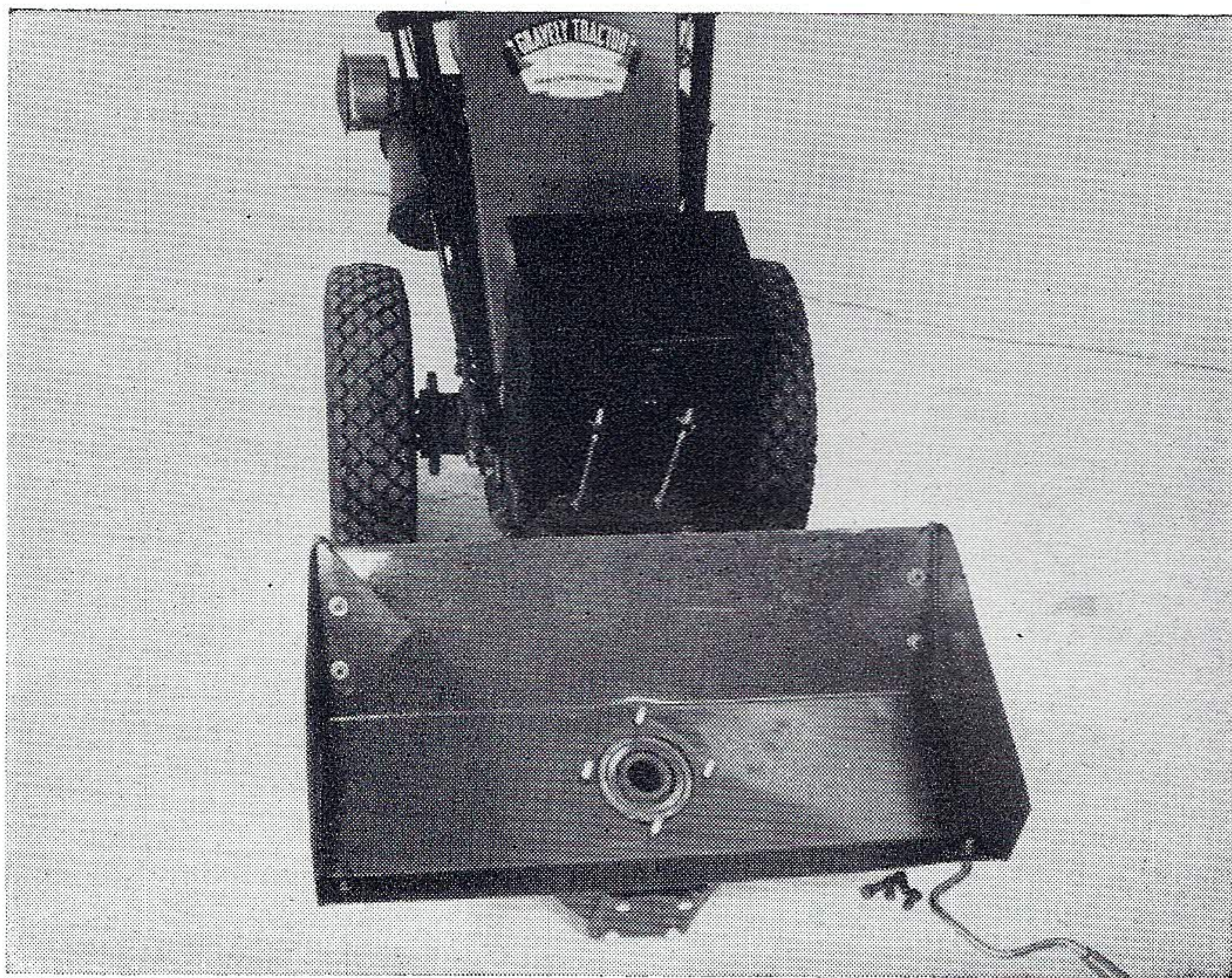

PLATE 35

## ASSEMBLY OF THE HOOD TO ROTARY PLOW HOUSING

With the Rotary Plow Drive in the same position as in Plate 34, fit the Hood as shown in Plate 35, with the long angle of the Hood towards the tractor.

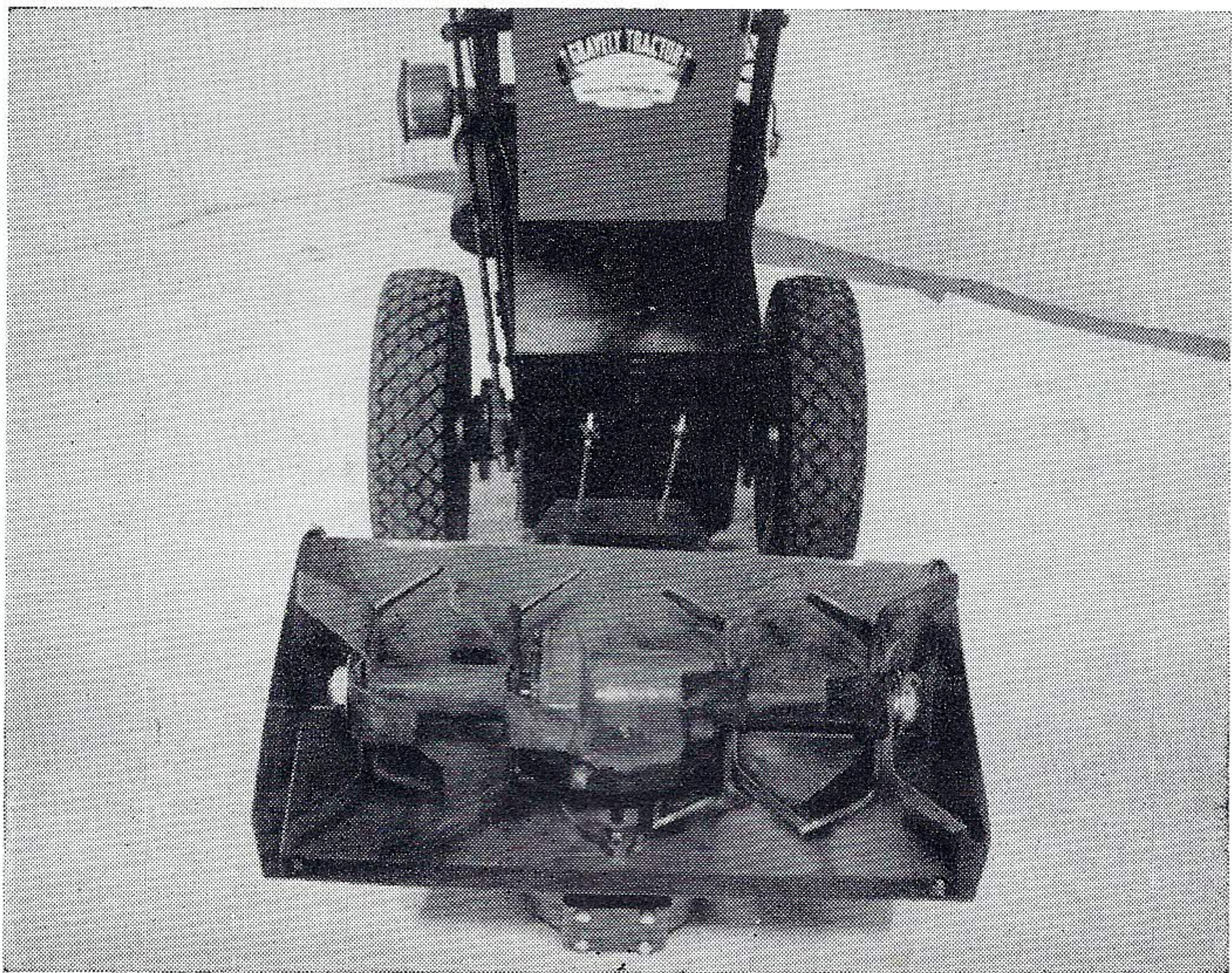

PLATE 36

## ASSEMBLY OF THE ROTARY CULTIVATOR DRIVE TO THE ROTARY PLOW

Now insert the protruding shaft of the Rotary Cultivator Drive into the Rotary Plow Housing. Using the elastic stop nuts, fasten drive firmly, making sure the Cap and Hood are properly seated. A Universal joint on a "speed handle" wrench is most convenient for doing this fastening job.

Now simply rotate the unit until it assumes the position as shown in Plate 37. In this position, the blades are cutting in the same direction as the Tractor wheels are turning, which is the recommended method for most work.

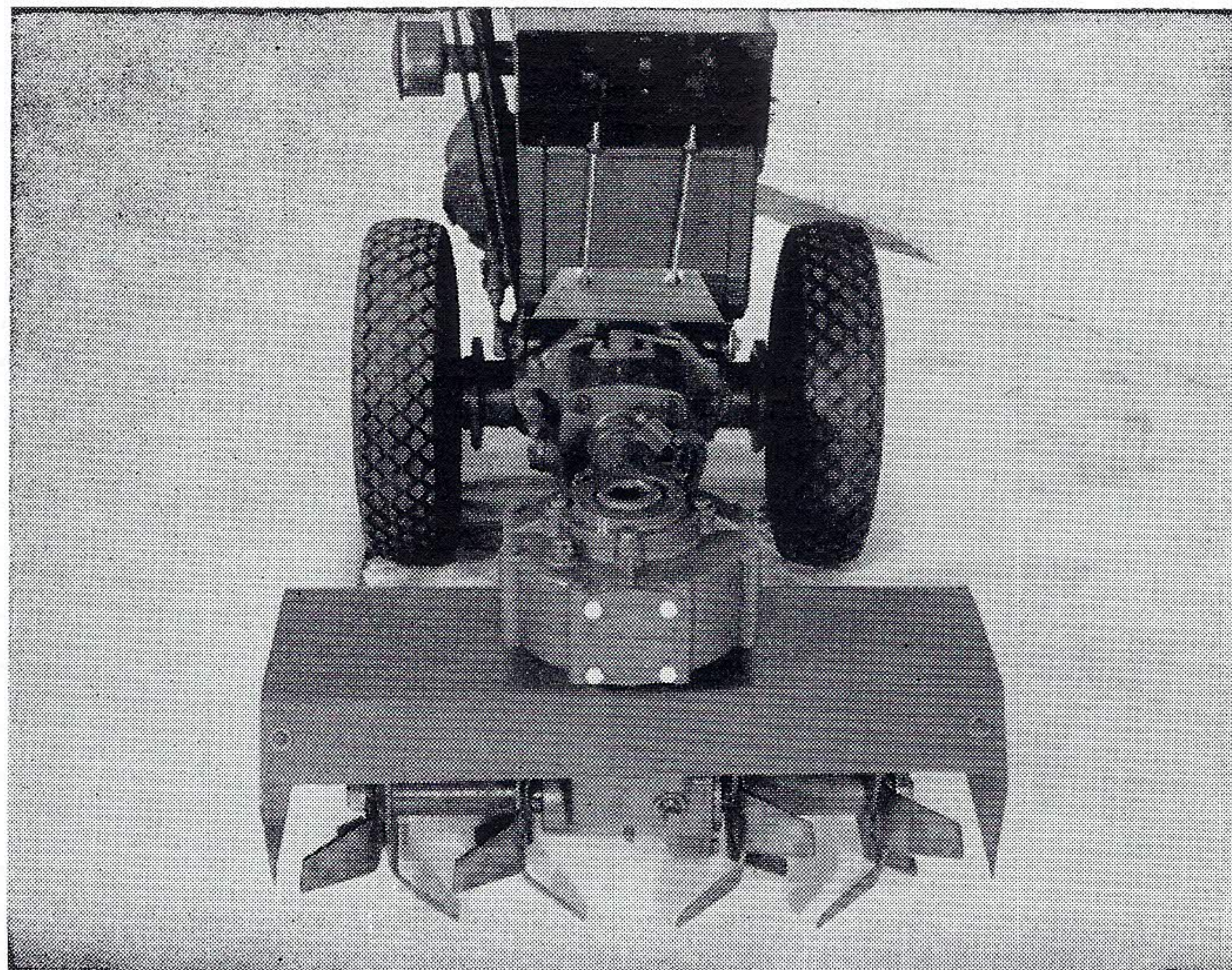

PLATE 37

Be sure to install dust seal and fastener on top of Hex Shaft.

Fill Both Rotary Plow and Rotary Cultivator Drives with oil. See "Lubrication."

## ADJUSTING BRACKET

See Plate 38. The Rotary Cultivator, for best results, should have its long axis parallel with the Tractor Axles.

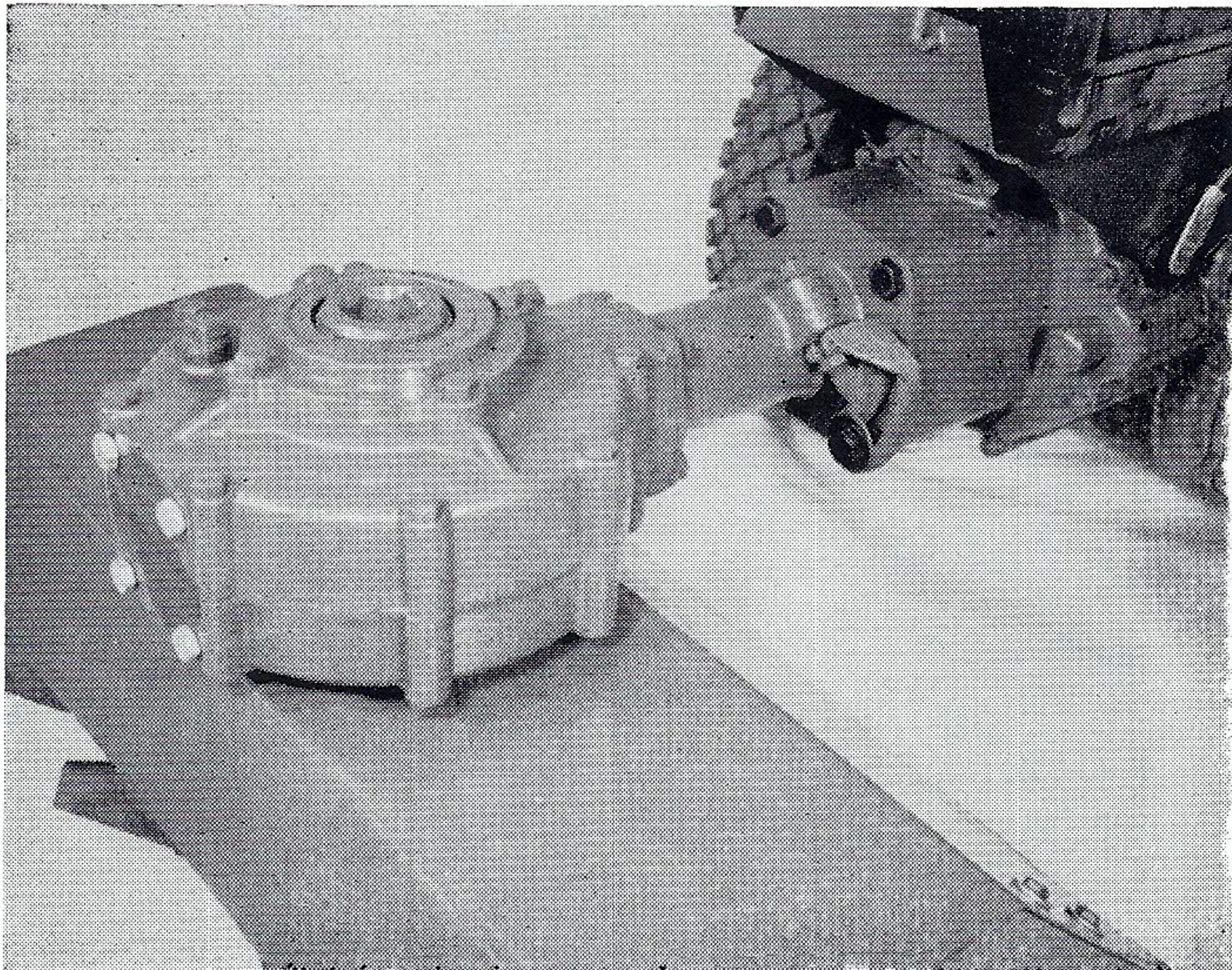

PLATE 38

Lock in place by the Adjusting Bracket, attached as shown.

SPACERS with the assembly are to be used when the Rotary Cultivator is removed from the Rotary Plow. The small cylinders are used over the studs, held in place by the stud nuts.

## LUBRICATION

There are two pipe plugs on the front of the Rotary Cultivator Housing. The large plug is an oil filler plug, the small plug is the oil level plug. We recommend Mobilube



GX 140 or GX 90. Fill until the oil begins to run out the level hole, reinsert plugs. A strip of paper folded to make a trough will be helpful in filling. Note that the unit should be setting level when measuring oil level.

## OPERATING HINTS

**CULTIVATING DEPTH** is obtained and controlled by light pressure on the Tractor Handles, either upward or downward. With the Tines revolving in the same direction as the Tractor Wheels, depth is controlled generally by the design of the Cultivator, and will cultivate to about a three inch depth.

To get slightly deeper cultivation, upward pressure on the Tractor Handles is necessary, conversely, to get less depth, slight downward pressure on the Tractor Handles.

A smooth seedbed without tractor wheel marks is obtained by the use of reverse (With the Tines Revolving in the same direction as the tractor wheels when the equipment is moving forward). This is an advantage in the preparation of lawn seedbeds, etc. With this arrangement, it is possible to cultivate right up to a wall, for example, then by backing away to leave a smooth, unmarked seedbed.

**TINE DIRECTION** of travel also controls the depth to some extent. If you wish to obtain greater depth as a general rule, we recommend that you assemble the Rotary Cultivator so the Tines revolve in the opposite direction to wheel rotation when moving forward. This is done by rotating the Rotary Cultivator Assembly through 180 degrees before attaching. In this case, it is usually necessary to use the Rotary Plow Depth Adjusting Wheel Assembly, to prevent the Cultivator from "digging in" and stalling the tractor.

**HOOD MANIPULATION** will give you added convenience. When you are cultivating a crop such as corn, which is generally cultivated in such a manner as to throw some dirt around the plants, removal of the End Plates from the Rotary Cultivator Hood will cultivate the center, and throw a very satisfactory ridge of dirt around the plant roots.

In all other cases, such as the cultivation of bushy crops, the End Plates should be in place to prevent tearing or damage to the plants.

**NOTE:** The Rotary Cultivator is designed to be a Cultivator. It is **not** recommended as a tool to prepare new ground for planting. New ground should be prepared with the Gravely Rotary Plow.

## TOOL CULTIVATING

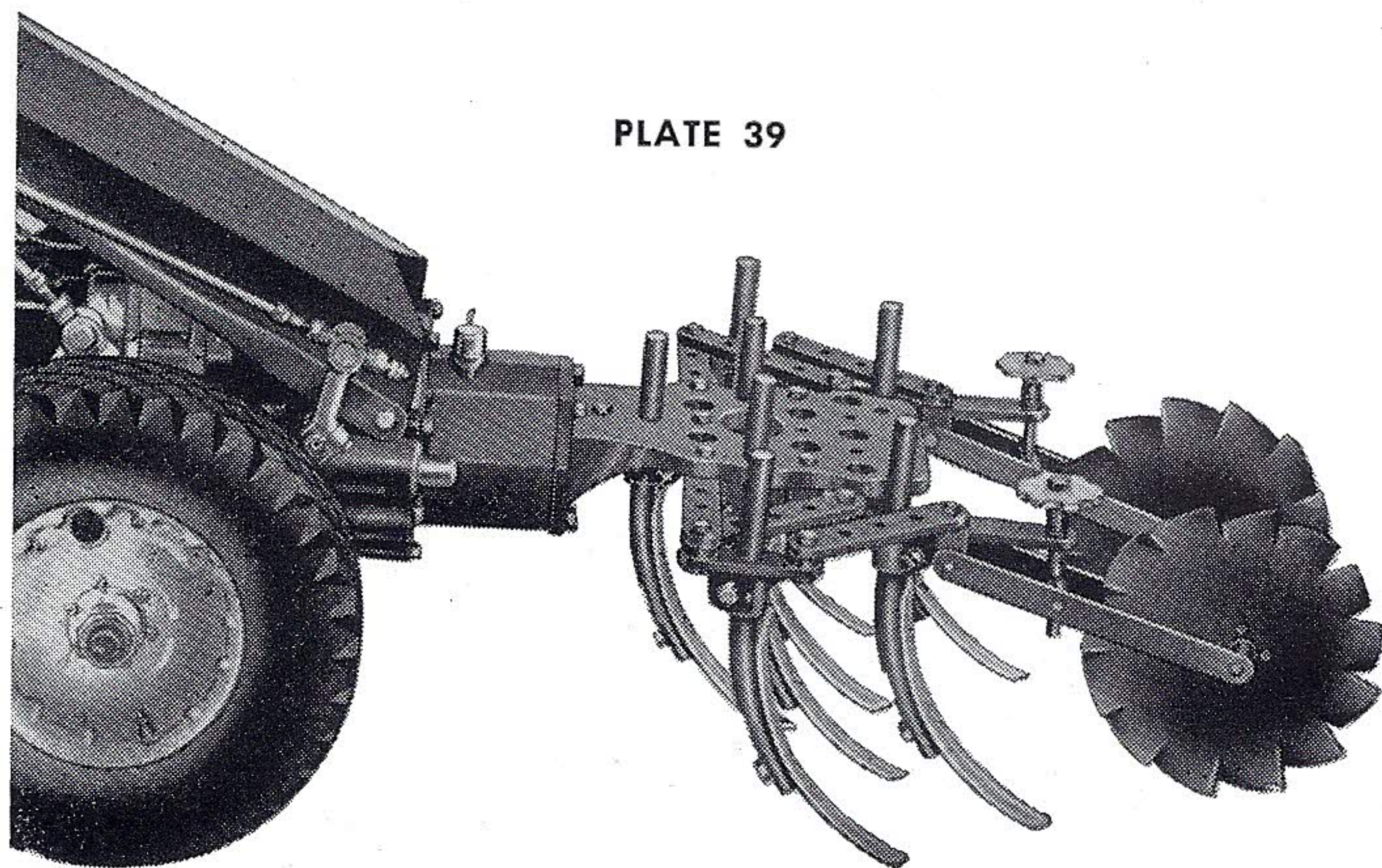

PLATE 39

You plow your ground only once or twice a season, but you cultivate many times. The Gravely Cultivator will save you many hours of hard, back-breaking hand work—make gardening a real pleasure by removing the drudgery!

The Gravely Cultivator uses all Cultivating Tools interchangeably on the same Toolholder. It is quick and easy to adjust to cultivate from eight to 30 inches . . . wider cultivation is possible by the purchase of extra Parallel Bars.

### ATTACHING THE TOOLHOLDER

The Gravely Cultivator can be attached to either the front or rear of the Tractor. Most people prefer the front, since the tools are all easily visible as you work, and control of the tools is easy by slight pressure on the handles.

To attach to the front, simply bolt the End Casting to the front of the Tractor, in the same manner as all front hitch attachments, using the four bolts furnished.

### ATTACHING THE SHANKS AND TOOLS

The Shanks are inserted in the Shank Holders from the bottom. First, loosen the hexagon head cap screw in the side until the Shank slips easily into place. Move the Shank up or down until it meets your requirements, then tighten the cap screw until the Shank is held firmly.

There are five Shank Holders already attached to the Cultivator in the proper positions. These may be moved, if desired, although this is seldom necessary. Additional Shank Holders may be purchased and attached to suit your needs, if desired.

The Tools are divided into two classes—those that require the "One-Hole" shank, and those that require the "Two-Hole" shank. All Cultivating Tools except the Furrowers, Hillers, Shovel Steel and Turning Shovel require the "One-Hole" Shank.

To attach to the Shanks, simply bolt in place with the bolts and nuts provided.

Changing from one tool to another only requires the switching of the Tools on the Shanks, unless you need a "Two-Hole" Shank where you have a "One-Hole" on the attachment. In that case change the Shanks also.

### ADJUSTMENTS

Depth Wheels are part of the Cultivator, whether used on the front or rear of the Tractor. They are used to set the depth the cultivating tools penetrate the ground.

With the Depth Wheels toward you turning the Hand-wheel to the right will give deeper cultivation; to the left, shallower cultivation.

Usually the Depth Wheels are all the adjustment you need. However, if necessary, you can adjust the Shanks in the Shank Holders up or down to meet your requirements.

### PARALLEL BARS

The Parallel Bars can be adjusted in several different ways, depending upon the task. Usually it is necessary to disassemble the Parallel Bars from the Depth Wheels to make these different set-ups.

## OPERATING HINTS

### HOW TO CULTIVATE

Cultivating depth and how close to plants to cultivate are individual problems and preferences. However, there are certain tips that may help you. You can set the Shanks individually, for example, so your Cultivator will be going deep in the center, and barely stirring the dirt next to the plants. This will save a lot of hand hoeing, and will not damage the plants when done with care.

Of course, you must plant your rows wide enough to accommodate the Tractor when you intend to use the Cultivator. The normal row width is about 32-36 inches. Wider rows should be used for plants that spread widely, unless you intend to shield the cultivator so you won't damage the plants.

**Occasionally a User tells us that he is not getting good results in hard ground, or very stony ground. The Cultivator will have a tendency to bounce up when it hits an obstruction. You can eliminate this very simply and inexpensively by filling a cloth or burlap bag with about 50 pounds of sand and laying it on the Toolholder. This will hold the Toolholder down, and does not make any appreciable difference in the handling of the Tractor.**

Users sometimes ask us why we don't "make the cultivator heavy enough to start with?". We may be old-fashioned, but to add the necessary 50 pounds or so of weight would add approximately \$18.00 to \$22.00 to the cost of the Cultivator. We believe your interests are served better by recommending a simple and inexpensive way to obtain the needed weight, rather than forcing you to pay more money, unnecessarily, for an attachment.

Incidentally, the Cultivator is very good for stirring deep litter in brooder houses.



## CULTIVATING TOOLS

All Tools Used on the Same Toolholder

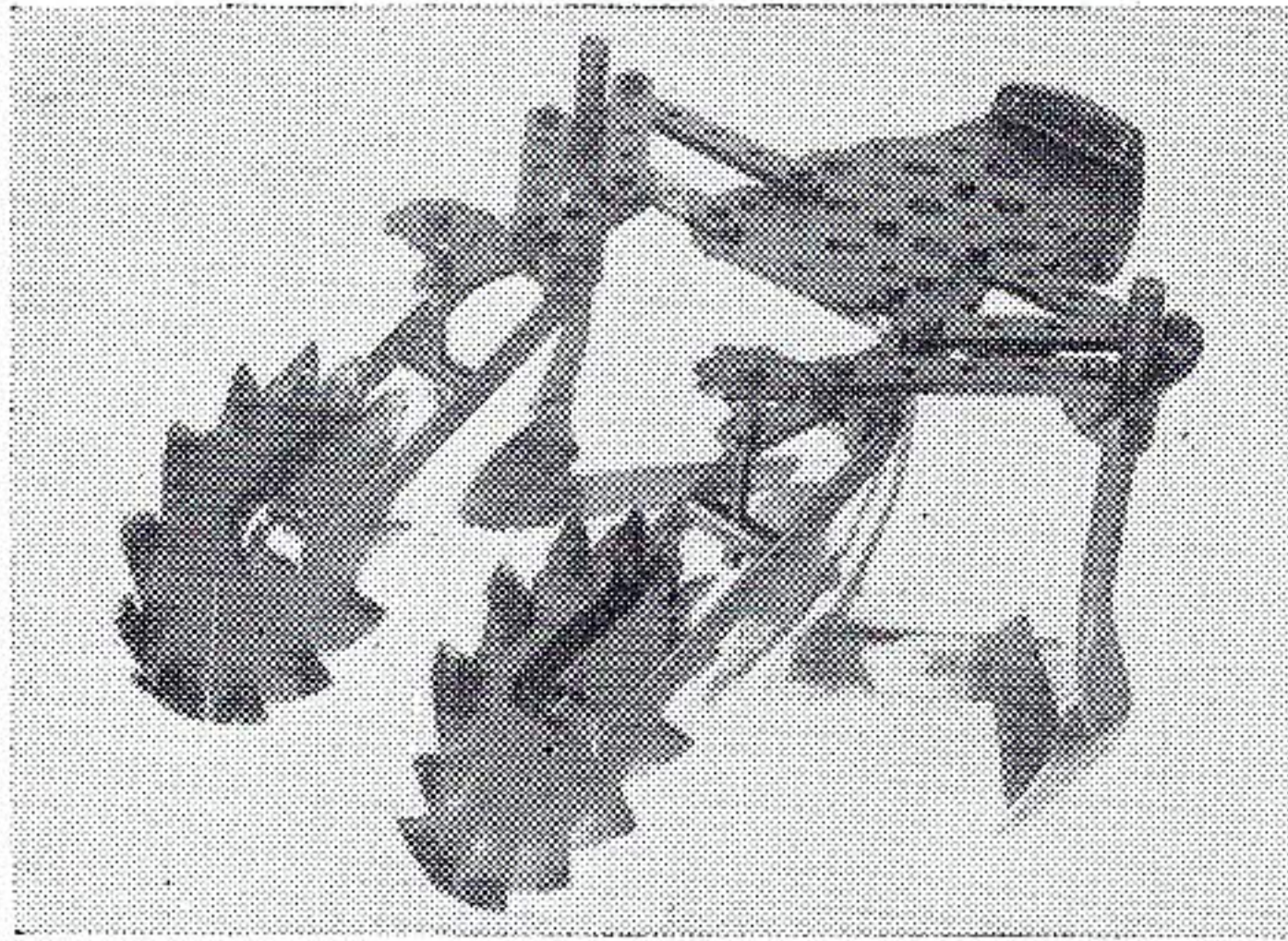

PLATE 40

**SWEEP AND HOE SET-UP** uses an improved Sweep in the center and a right and left Gravely Hoe on either side. The Sweep may be obtained in 8, 10, 12 and 18-inch sizes. The Sweep clears the center of weeds and trash, and the special Gravely Hoes eliminate the majority of hand work close to the plants.

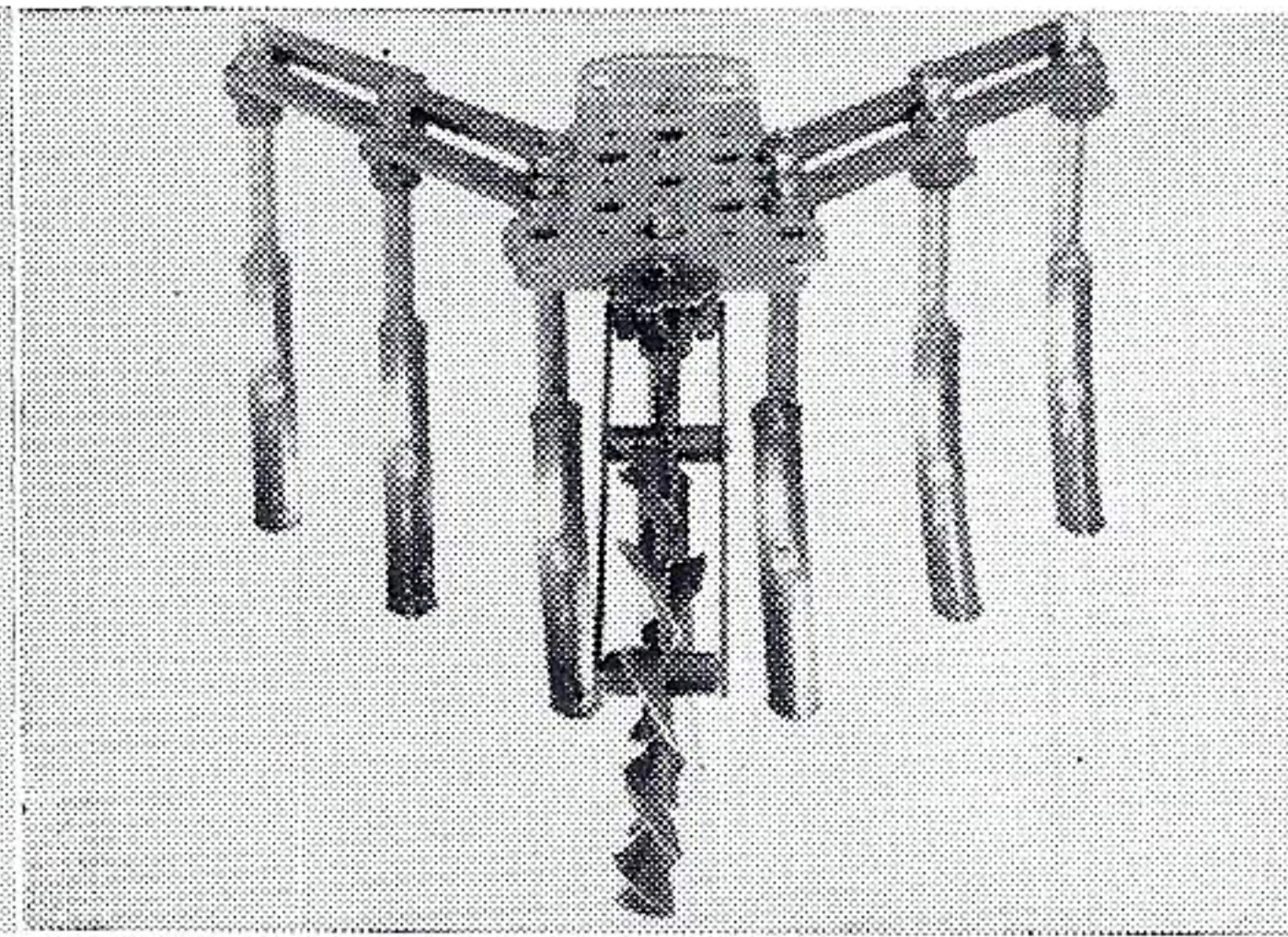

PLATE 41

**7 STEEL V SET-UP** uses one Depth Adjusting Wheel with the parallel bars arranged to form a V. Depth is obtained by a single adjustment of the Depth Wheel. The cultivator will follow the contour of the ground closely, and the last two steels shield foliage and vine crops so that they will not be bruised by the wheels.

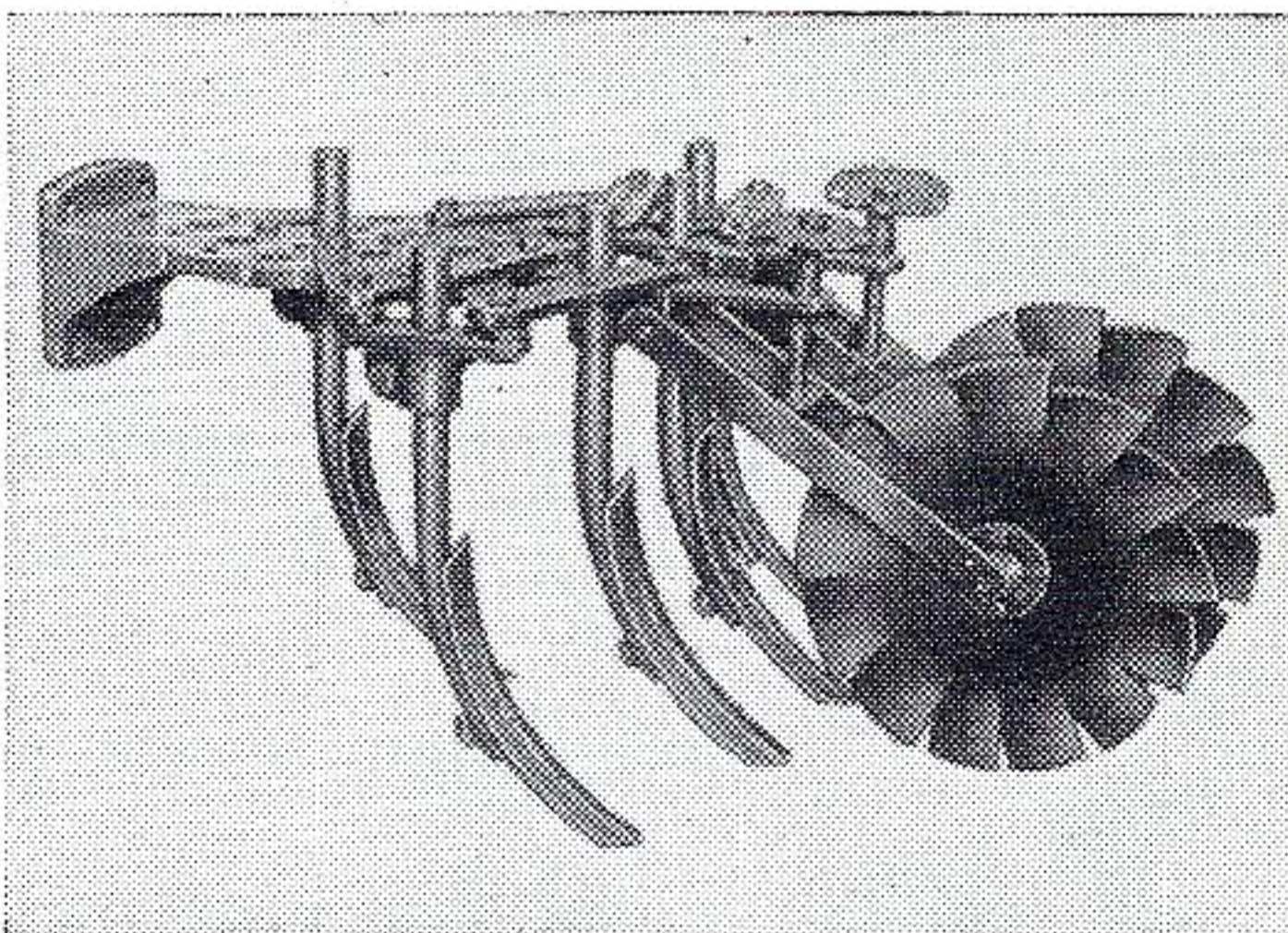

PLATE 42

**5 STEEL SET-UP** is the standard arrangement, uses 1 1/4" steels. Extra steels and shanks may be purchased. The picture, Plate 39, on page 18 shows the method of arrangement when seven steels are used. Steels are available in 1 1/4", 1 3/4", and 2 1/4" sizes. All cultivating tools are used on the same toolholder, are interchangeable.

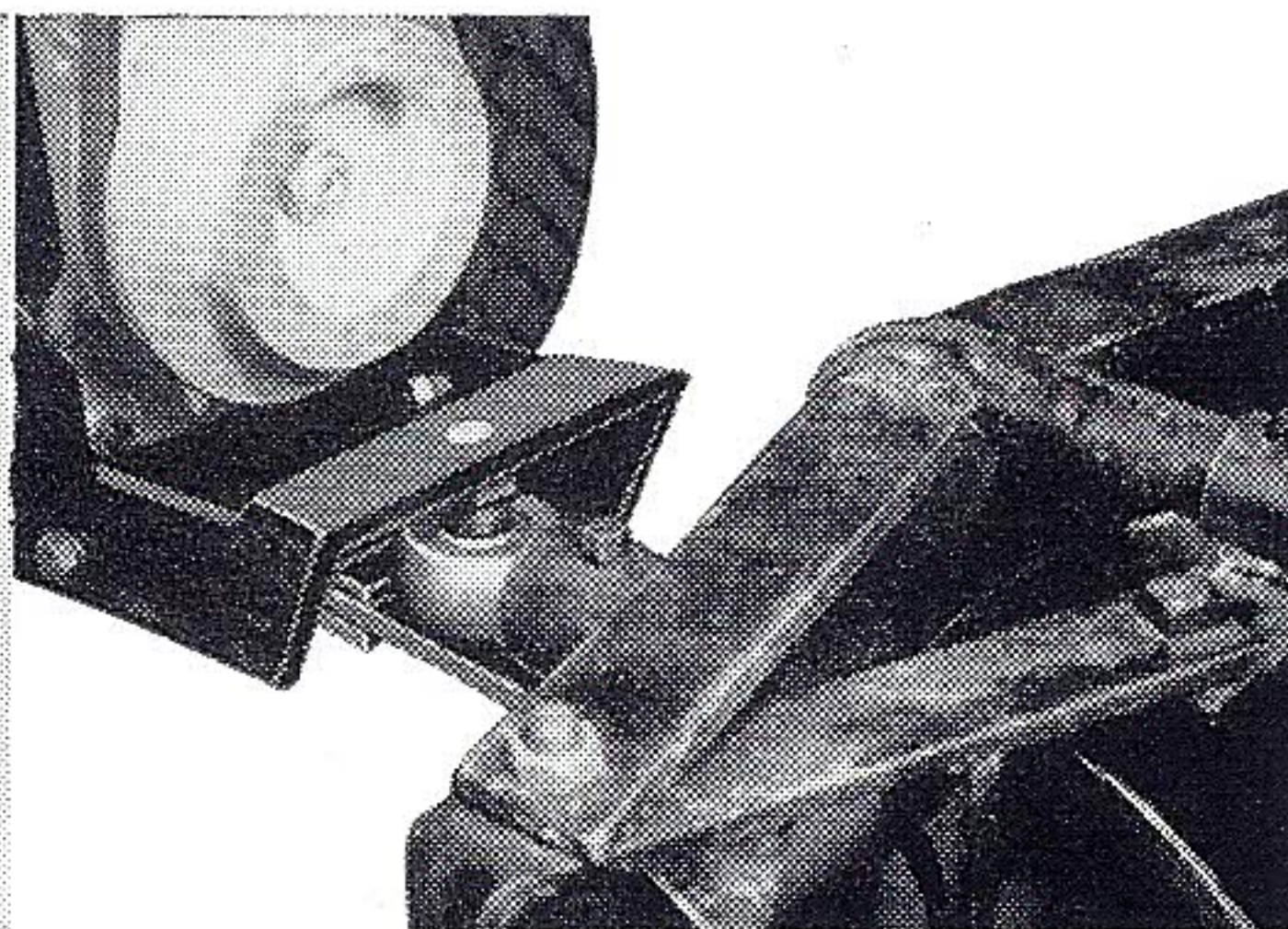

PLATE 43

**DISC HARROW** The Rear Disc Harrow is used mostly for cultivation since the Gravely Rotary Plow gives a perfect seedbed without any type of harrowing or dragging. The Disc Harrow requires the Rear Hitch. It is attached as shown. An occasional squirt of Mobiloil on the Axle is the only lubrication required. Pitch of the Discs is adjusted by releasing the Clamp Screw, and adjusting the pitch of the discs to your requirements.

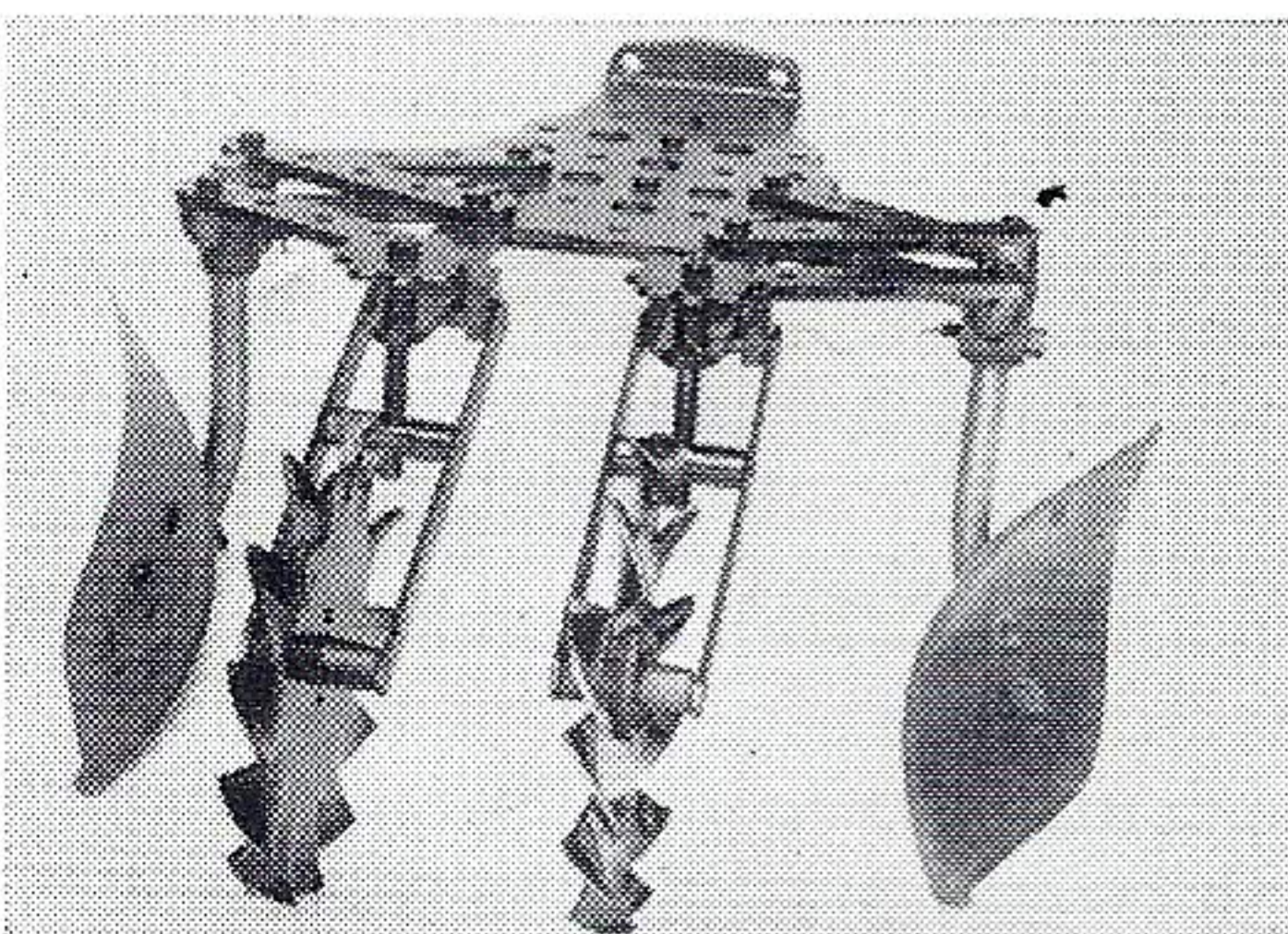

PLATE 44

**6-INCH HILLER SET-UP** uses right and left hillers, can be used for closing rows as well as hilling. They throw dirt away from or around the plants, as you desire. You can use a furrower in the center at the same time, bringing the dirt from the center of the row to the hillers which in turn heap it around the plants.

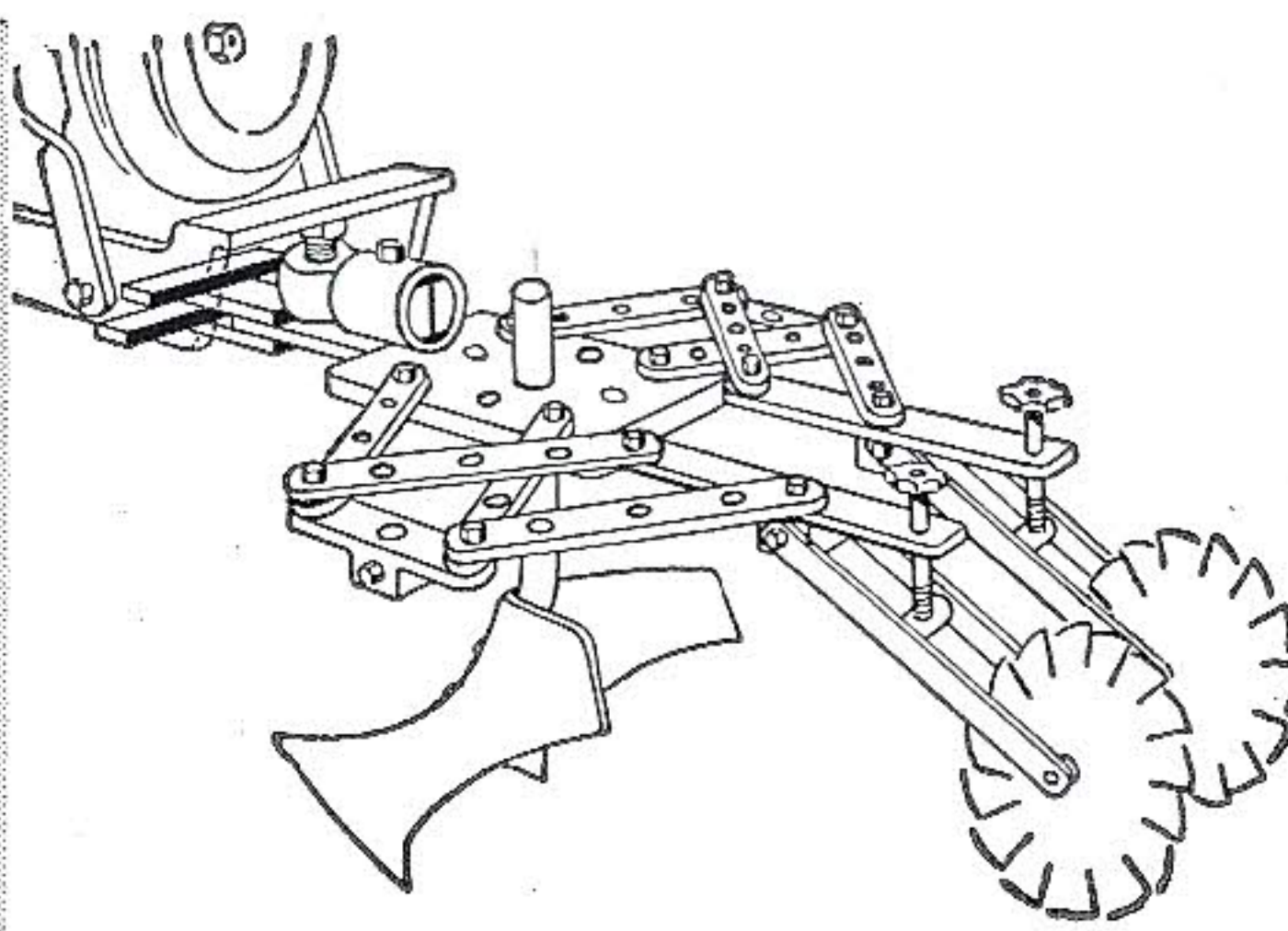

PLATE 45

**FURROWERS** are available in 10 or 12-inch sizes, may be used front or rear to lay off rows for planting. Many users also find it a good tool for digging potatoes. For smaller furrows, seven-inch shovel steels are available. These are very handy for laying off small seed crops and can be used for center row cultivation.

## REAR CULTIVATOR

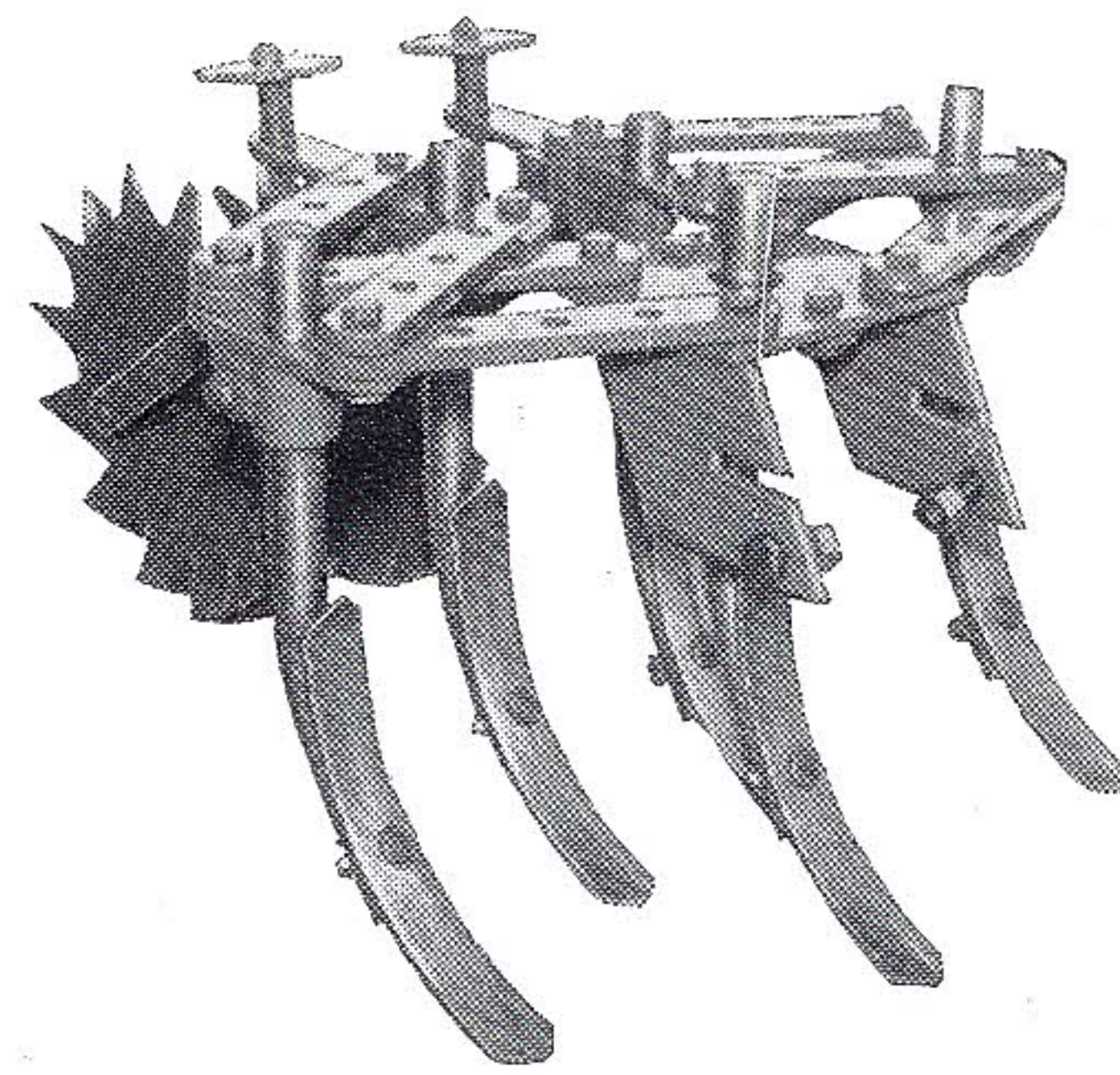

PLATE 46

Many of our Users prefer the Rear Cultivator, because when used on the rear of the Tractor, the cultivator loosens the dirt previously packed down slightly by the wheels. Set-up of tools, and adjustments for depth are the same as shown for the Front Cultivator.

Rear Hitch required.

## SNOWBLOWER INSTRUCTIONS

### OPERATING INSTRUCTIONS

### GRAVELY SNOWBLOWER ATTACHMENT

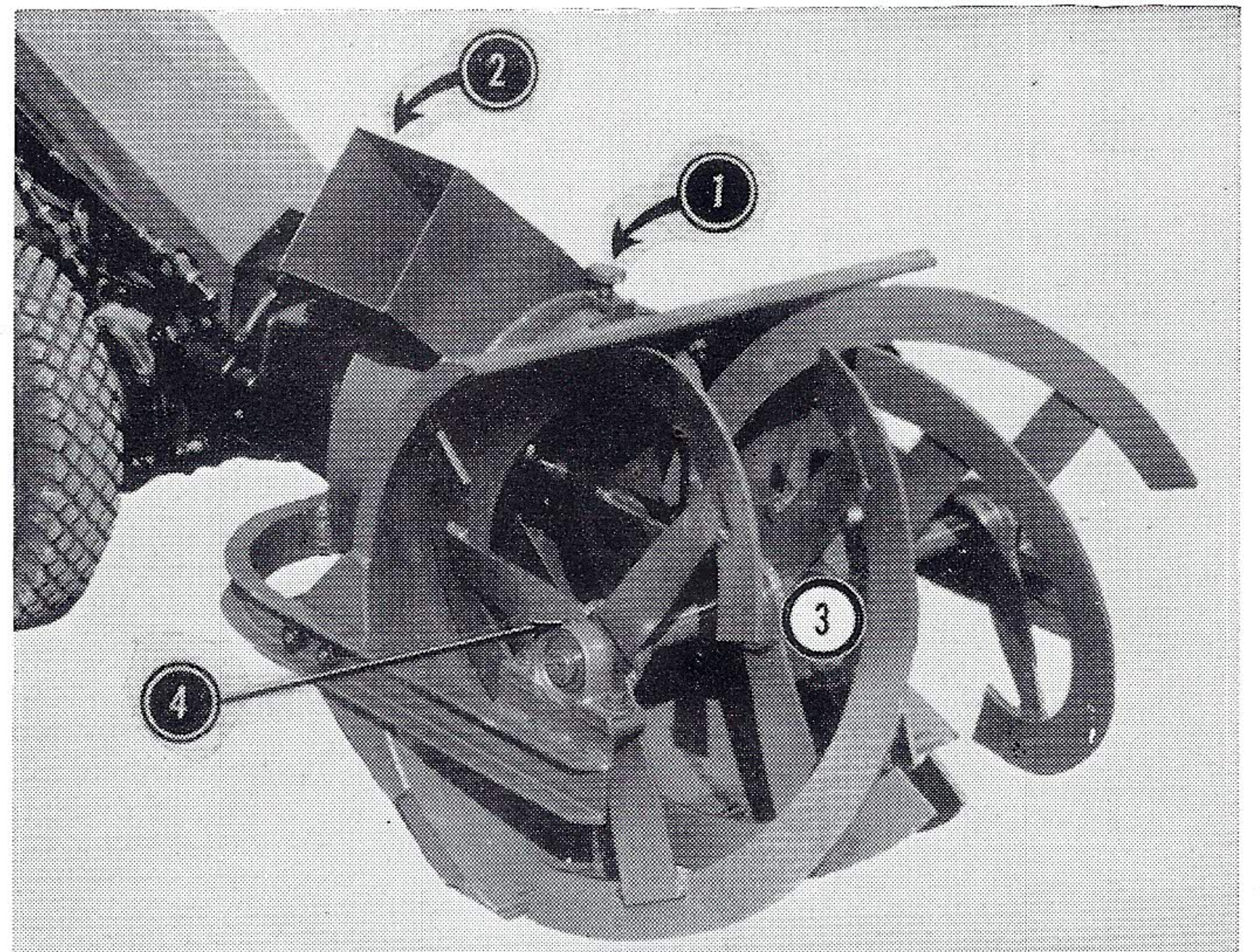

PLATE 47

1. Discharge Spout Clamp Wheel. 2. Discharge Spout. 3. Gear Housing. 4. Pillow Block Alemite Fitting.

### LUBRICATION

On the Gear Housing of the Snowblower are two pipe plugs, one large, one small.

Remove both plugs. Fill the Gear Housing through the large hole with Mobilube GX-90 until it begins to run out the small hole, which is the oil level. Avoid putting in more Mobilube than is required to fill to the level of this level plug.

There is an Alemite fitting on the swivel housing. This requires an occasional shot of Mobilgrease MP.

The pillow block bearing requires a shot of Mobilgrease MP in Alemite fitting as needed. The amount of lubrication required will vary according to your use. However, usually these bearings will only require lubrication two or three times a season.

### ATTACHING

The Snowblower is attached to the front of the Tractor with four bolts.

### ADJUSTING

The Spout is adjustable to any angle within practical working limits, by loosening a Handwheel and small clamp. To operate, STOP THE ATTACHMENT by throwing out the Attachment Clutch Lever. Then loosen the Handwheel slightly, until the Fan Housing will turn. Adjust it to the angle you desire, then tighten the Handwheel down against the Clamp to hold the Discharge Spout in the chosen position.

The Skids are removable by the use of a screwdriver.



### MOVING VERY DEEP, HEAVY SNOW

We recommend that where you anticipate many hours of operation in deep, heavy snows, you purchase Gravely Geared Wheels. These wheels slow the forward speed of the Tractor one-half, while the Attachment remains at the same speed. This will give you much more efficient action, and more power for the wet snows. The only other method of obtaining the same results is to "slip" the Clutch. This works for awhile but—as in an automobile—Clutch slipping will soon cause excessive wear on the Clutches, and require replacement.

### HINTS AND CAUTIONS

NEVER attempt to kick, adjust or tinker with the Reel, Fan Housing, or Discharge Spout while the attachment is in operation.

### WARNING—NEVER PUT HANDS IN DISCHARGE SPOUT WHEN ATTACHMENT IS IN OPERATION.

BE CAUTIOUS when operating on gravel or rock surfaces. If a heavy rock is carried to the fan it will be expelled with enough force to hurt a person standing in the path of snow discharge, or break windows in automobiles and homes.

An optional set of Casters is available for the Gravely Snowblower, giving greater maneuverability. Also, by being able to adjust the height, it is possible to use the Snowblower on bluestone and gravel drives, minimizing the danger of picking up loose material and throwing it through the Blower.

### TRAVEL SPEED

To remove a maximum amount of snow, the operator should keep the machine with full engine load at all times. This means that the forward speed should be shifted from low to high gear as required by the depth and density of the snow.

If you own a new Snowblower, the Fan has been extended. On some older models, "clogging" of the intake openings occurred with deep wet snows, especially when operating in freezing weather. If you own an older Snowblower with this problem, we suggest you have your Gravely Dealer install the new, extended fan.

Also, there are several Silicon Base preparations on the market that may be used to coat the working surfaces of the Snowblower, and will make the operation more efficient.

If your tractor suddenly stops while Snowblowing, check the vent in the Gas Tank Cap. Sometimes snow will pile up and/or freeze, stopping up the vent and giving a vapor lock which stops the Tractor. In freezing weather, the same thing may be caused by gas line or Carburetor freeze up, caused by water condensing in the gas. We recommend you use anti-ice additives in the gasoline in the winter, and always keep a FULL TANK of gas to minimize condensation and consequent freezing.



PLATE 48

### 48-INCH SNOW PLOW, BLADE TYPE

The Gravely Blade Type Snow Plow will clear the average sidewalk in one sweep, the driveway in two. It will

move snow as deep as 18 inches, deriving its efficiency from its design—the blade does not push the snow, it ROLLS it out of the way.

### ATTACHING

The Snow Plow is attached to the front of the Tractor by means of four bolts, in exactly the same manner as all other front hitch Attachments.

### LUBRICATION

None required.

### ADJUSTMENTS

The Gravely Blade Type Snow Plow is adjustable to throw the snow to the left, right, or straight ahead.

This is done by simply removing the large "T" (Adjusting Bolt and Handle) and swinging the Blade to the position desired, lining up the proper hole in the Bracket with the hole in the Swivel, and dropping the "T" in place to hold it.

The Wearing Strip on the bottom of the Blade will eventually need replacement. All you do is remove the screws that hold it in place, replace the old Strip with a new one, and reinsert and tighten down the screws.

Skids for the Snow Plow are available from your Dealer. They are installed by removing the end screws from the Wearing Strip, and inserting the long screws furnished with the Skid. Then slip the Skid on the screw from the back of the blade, with the long side down and parallel to the ground, and fasten tightly with the nut.

### OPERATION

Skids are useful in two places . . . where you are working on concrete pavement where one section is higher than another, forming an edge that will catch the plow as you go along, and on gravel or bluestone drives where you want to remove the snow but not the drive.

### SNOW REMOVAL

Chains available from your Gravely Representative are always helpful, especially on icy pavement.

### BULLDOZING

The Blade comes in handy for many other uses other than removing snows. You can grade loose dirt, for example, and a set of Dual Wheels (described on page 14) will help you get the maximum amount of work from the Blade.

Many dairy farmers and cattle farmers use the blade for cleaning up the concrete holding pens next to the milking parlor. Some even take the tractor right inside the barn and clean the barn interiors with the Blade.

Poultry Farmers have also found the Blade useful for clean-up work in brooder houses. The Tractor will go through most doors, and once inside can make short work of cleaning out dirty litter and droppings.

Motels, Parking Lots, Hotels, and Drive-In Theatres with gravel drives and parking areas use the Blade in reverse to level the drive material. By backing up the tractor, the Blade smooths out the humps and dug-out places into a level surface again.

Landscapers find the Rotary Plow/Rotary Cultivator and the Blade Type Snow Plow a good combination for lawn preparation. The lawn is plowed first, then the Bulldozer is used to terrace or grade, finally going over the area to be seeded IN REVERSE, with the blade following the Tractor. This gives a very even, smooth seedbed properly prepared for lawn seeding. In some cases, the lawn is seeded, then the Blade is used again in the same manner. This sets the seeds at about the right depth for good germination.



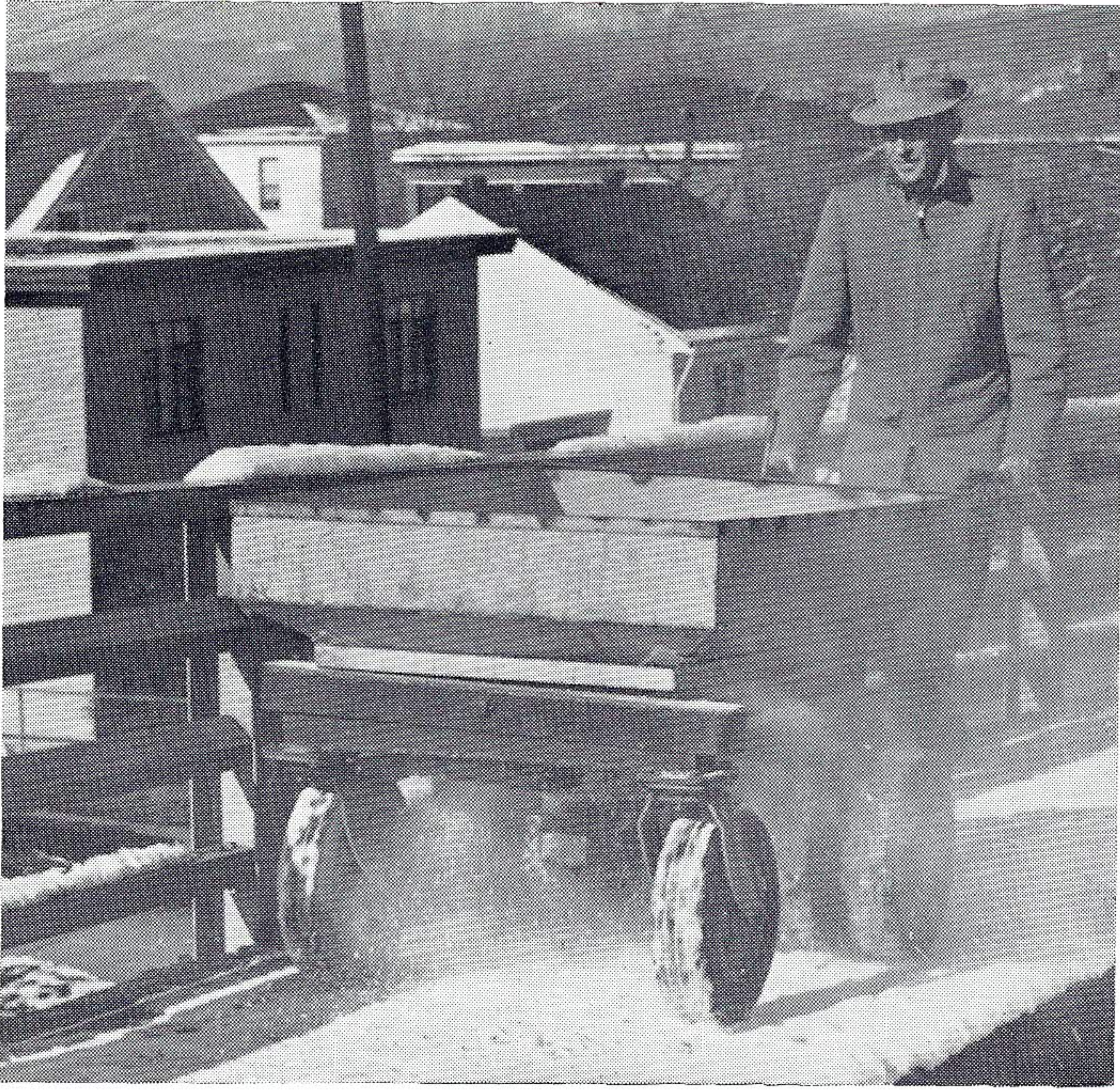

PLATE 49

#### POWER SPREADER

The Gravely Power Spreader (above) spreads a width from 4 to 12 feet and a length of 1,050 feet in one loading. It spreads salt, sand or other snow-removal substances, as well as granular fertilizer. Write for special instructions.

#### POWER BRUSH

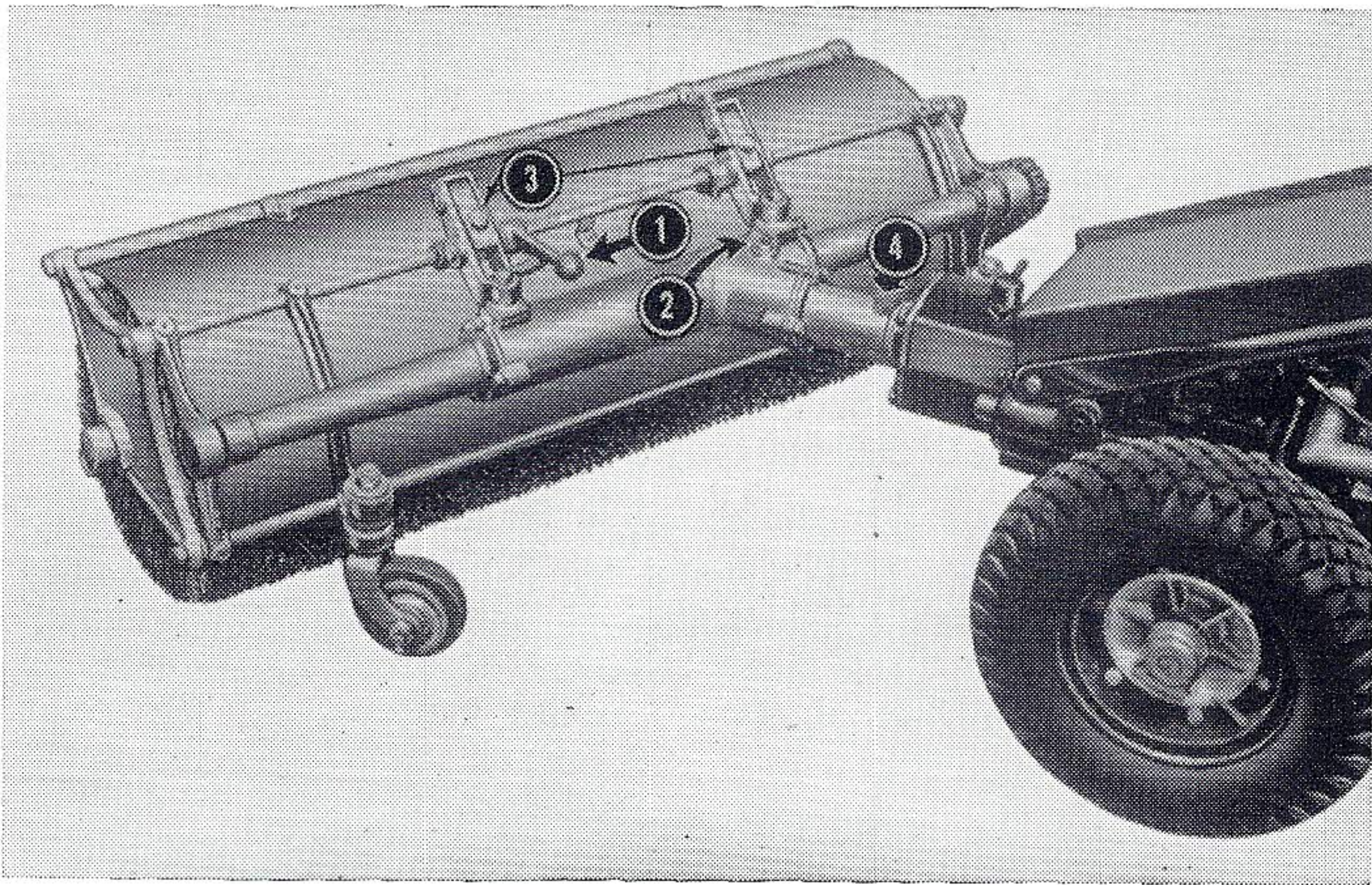

PLATE 50

- |                        |                                  |
|------------------------|----------------------------------|
| 1. Brush Contact Lever | 3. Brush Tension Adjusting Bolts |
| 2. Oil Filler Plug     | 4. Swivel Grease Cup             |

The Gravely Power Brush is a useful tool for cleaning parking lots, drives, sidewalks, and other areas where power sweeping is necessary.

The Brush is also useful for sweeping of light snows—it will handle snows up to about six inches deep, brushing clean to the pavement unless there is an ice-skim under the snow.

#### ATTACHING

The Power Brush is attached to the front of the Tractor by four bolts, in the same manner as all front hitch Attachments.

#### LUBRICATION

On the drive of the Power Brush next to the Tractor you will see either a Cup or an alemite fitting. This lubricates the Swivel and should be given a shot of Mobilgrease MP as needed.

On the section of the drive next to the Brush is a large Oil Filler Plug. The drive should always contain enough

Mobilube GX-140 so that the Gears will dip halfway in the oil. Of course, the attachment should be level when this checking is done. You can determine if the attachment needs oil by removing the Oil Filler Plug and looking down into the gears through the Oil Filler Hole.

No other lubrication is necessary except an occasional squirt of motor oil on the Chains.

#### ADJUSTMENTS

CHAIN DRIVE adjustments are made by removing a half link when the Chain has been driving long enough to "stretch." This usually takes several months of use.

BRUSH CONTACT is adjusted by the Brush Adjusting Bolts. (See Plate 50). Put the Brush in contact with the floor by lifting the Contact Lever up. Then turn the Bolts until the tension desired is obtained.

The proper tension for the Brush is something that must be learned by trial. It must have enough pressure to sweep clean. It is best to adjust downward gradually until the correct pressure is obtained. **Too much pressure will cause the brushes to wear out prematurely.**

#### REVERSING OR CHANGING BRUSH STRIPS

If you find that the Brushes have worn more on one side than another, it is time to reverse the Brushes in the Brush Spiders. Reversing or changing a Strip involves the same operation—merely loosen the bolts that hold the Wedges in the Spider and remove the Strip. Reverse it or insert a new one, put the Wedges in place and tighten down the bolt. Adjust to the proper tension by the procedure described in "Brush Contact."

Extra Brush Strips are available from your dealer.

#### TRANSPORTING THE BRUSH

To save unnecessary wear on the Brush, a Brush Contact Lever is provided which, when it is in the down position, will carry the Brush above floor level. When the Lever is pulled up, it will contact the Brush to the Floor.

**You will greatly increase Brush life if you wet down the Brushes before use, and keep them wet during prolonged use.**

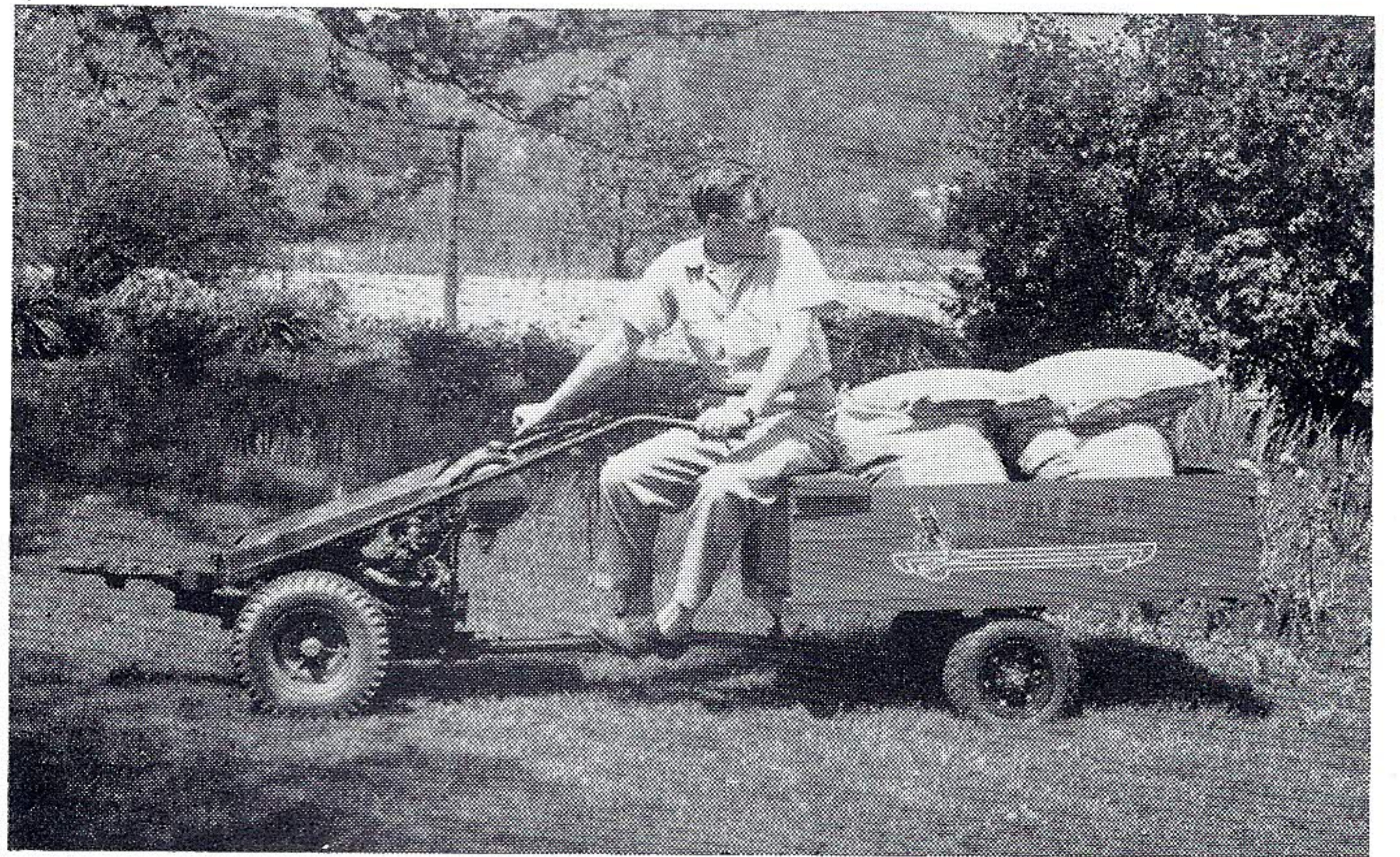

PLATE 51

#### HAULING CART

There are always odd jobs of hauling to be done . . . and the Gravely Hauling Cart will handle a thousand pound load!

The Cart attaches to the rear of the Tractor, has a Seat on which you can ride while hauling.

Cart sides are removable, and stakes can be put in their place for hauling bulky materials, such as hay. The Cart is equipped with a releasing Latch that dumps the Cart with no effort on your part, and pneumatic tires.

#### ATTACHING

The Cart requires the Rear Hitch. For attaching Instructions, see next page.

#### LUBRICATION

The only lubrication required is an occasional shot of Mobilgrease MP in the Alemite Fitting on each Wheel Disc.



## POWER TAKE-OFF

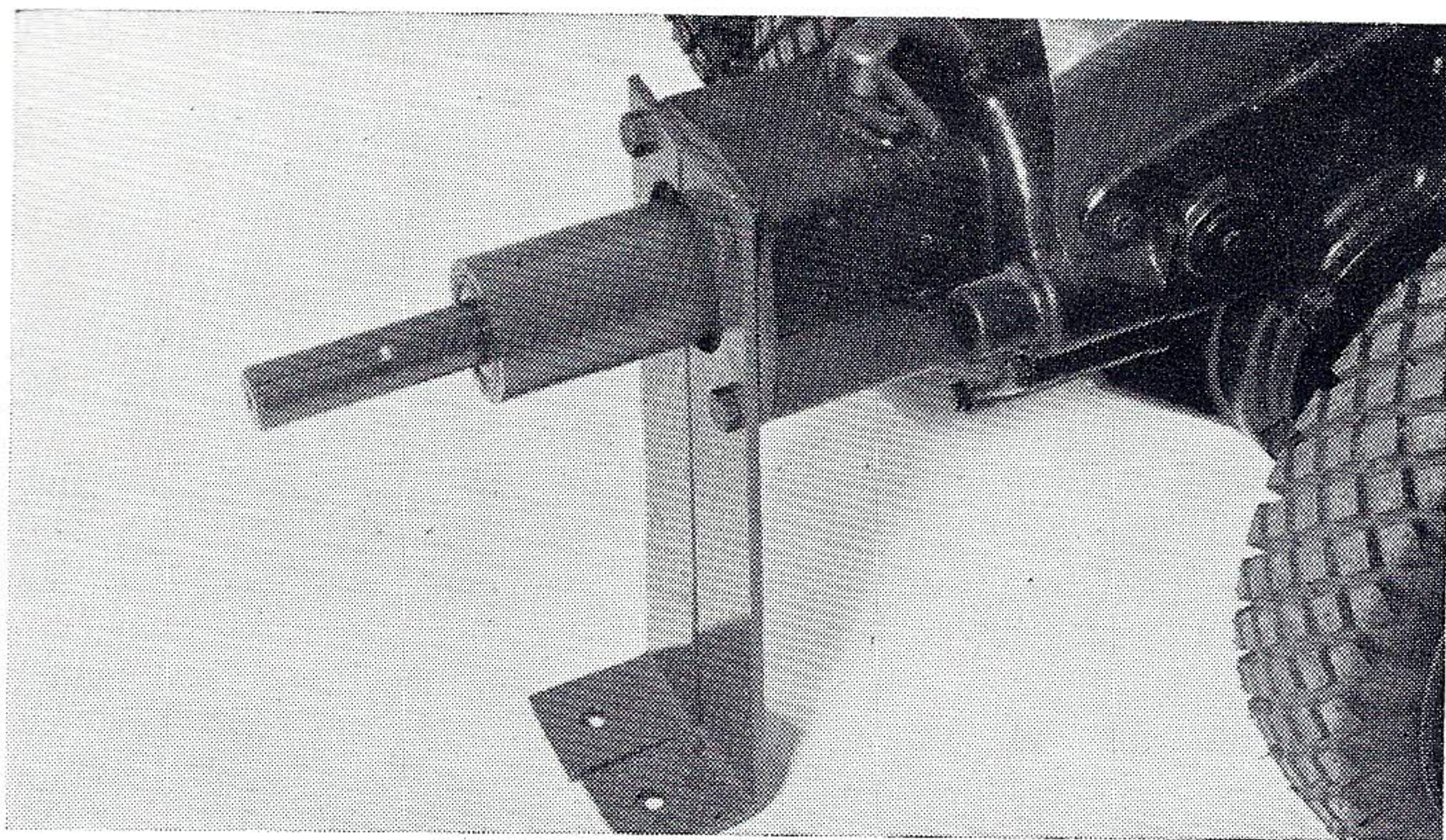

PLATE 52

The Gravely Power Take-Off is useful for running any equipment that gets its power from a belt, and that requires not more than 4.8 Horsepower to operate it.

### ATTACHING

The Gravely Power Take Off is attached to the Tractor by four bolts, as are all power attachments. However, the Stand, at your option, may be bolted on at the same time as you attach the Power Take Off to the Tractor.

The standard bolts will hold the attachment, but we recommend that when using the stand you use a bolt  $\frac{1}{4}$  inch longer in length. These are available from your dealer.

If you have a job that requires the use of a Power Take Off frequently, sometimes it is a good idea to bolt the Stand in the proper place for the job. Then you can simply run the tractor onto the Power Take Off, tighten down the bolts and be ready for operation.

### LUBRICATION

None required.

### BELT ALIGNMENT

Always be sure that the belts are in alignment during operation. Proper tension is a matter of trial for the individual task to be performed. The same applies to the size of Pulley needed.

### CAUTION

Do not run engine wide open on any belt job, for any extended period of time.

### HOW TO FIGURE PULLEY SIZE AND RPM

Sometimes you will have to figure how to use the Power Take Off with a piece of equipment that has a certain speed at which it should operate.

To find out which size pulley to use, and what RPM will be generated, AT NORMAL WORKING SPEED—(throttle  $\frac{2}{3}$  down) use the table below.

| P.T.O.<br>Pulley<br>Dia. | DRIVEN PULLEY |      |      |      |      |      |      |      |      |
|--------------------------|---------------|------|------|------|------|------|------|------|------|
|                          | 4"            | 5"   | 6"   | 7"   | 8"   | 9"   | 10"  | 11"  | 12"  |
| 4"                       | 1200          | 960  | 800  | 685  | 600  | 533  | 480  | 436  | 400  |
| 6"                       | 1800          | 1440 | 1200 | 1028 | 900  | 800  | 720  | 654  | 600  |
| 12"                      | 3600          | 2880 | 2400 | 2057 | 1800 | 1600 | 1440 | 1309 | 1200 |

The above speeds are based on P.T.O. speed of 1200 R.P.M. in high gear with engine operating at 2400 R.P.M. (Throttle  $\frac{2}{3}$  down.)

## REAR HITCH

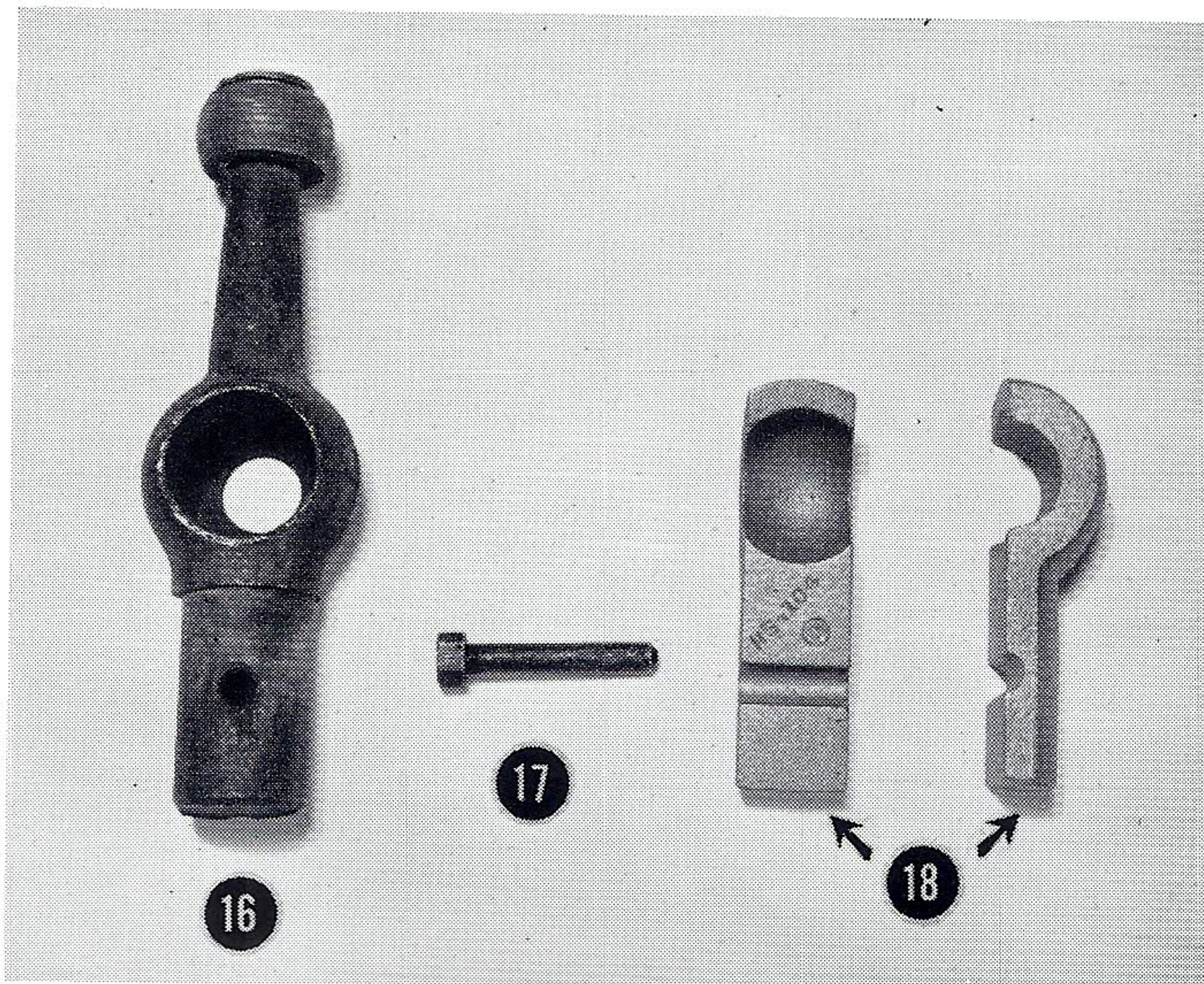

PLATE 53

16. Roller Rest Socket (used with all rear attachments needing support at the hitch: i.e. Hauling Cart. 17. Hitch Pin. 18. Split Socket (used with all attachments when another attachment is used on the front of the tractor), i.e. Riding Sulky.

The Rear Hitch is required for the Riding Sulky, Steering Sulky, Hauling Cart, Hay Rake, Disc Harrow, Rear Cultivator, Turnplow, and 5' Seeder, Spreader.

### ATTACHING

First, attach the Braces loosely to the Frame of the Hitch, with the short twist down.

Remove the second bolt from the bottom of the Chassis Casting, on both sides.

Slip the Frame in place, with the Steel Strip on the extreme end of the Frame on top.

Insert the two  $\frac{1}{2}$ " x  $1\frac{1}{4}$ " bolts and tighten. (These are furnished with the Rear Hitch.)

Remove the nuts from the L-224 Bracket, slip the Braces on, replace the nuts. (On Tractors with serial numbers less than 80,000, the length of the stud in the L-224 Bracket may be inadequate if both the Rear Hitch Brace and the Governor Bracket is mounted. In this case, order a new L-224 Bracket from your dealer.)

Now place the large nut on the Ball Stud, running nut up to the end of the threads. Screw the Ball Stud into the threaded hole on the Rear Hitch Cross Piece. Place the second nut on the threads and lock tightly to the frame, with the Ball towards the ground. (The bottom of the Ball Stud has an opening to fit a  $\frac{1}{4}$ " Allen Wrench.)

Run the Ball Stud Lock Nuts TIGHTLY against the Box Frame. IT IS IMPORTANT TO TIGHTEN THE NUTS SECURELY AGAINST THE REAR HITCH FRAME BECAUSE THE NUTS, INSTEAD OF THE THREADED STUD, MUST TAKE THE THRUST. UNLESS YOU TIGHTEN BOTH NUTS YOU MAY STRIP THE THREADS IN THE REAR HITCH FRAME.

To Level the Tractor, after an attachment is in place, loosen the Ball Stud Lock Nuts. To raise the handles, turn the Ball Stud clockwise. To lower the handles, counterclockwise.

IMPORTANT! Attachment Boss Cover, or Toolholder Frame must be used on the front of the Tractor when using a Rear Attachment!

### LUBRICATION

None required.



## INDIVIDUAL ATTACHMENT INSTRUCTIONS

### LAWN ROLLER, TRANSPORTATION CART (Same methods apply to both)

#### ATTACHING

Assemble the Roller Rest Socket by slipping the Roller over the small end, and securing it in place with the Retaining Ring.

**UNLOADED,** Place Socket on Ball Stud, with the Roller end of the Roller Rest Socket resting on the Rear Hitch Bottom Cross Piece. While holding the Roller Rest Socket in this position, bring the hollow Draw Bar over the end of the Roller Rest Socket, and drop the Draw Bar Pin in place.

**LOADED,** Attach the Roller Rest Socket to the Draw Bar. Bring the Tractor with Rear Hitch to the attachment, then stand the Tractor on its "nose." Guide the Roller of the Roller Rest Socket into position on the Rear Hitch Bottom Cross Piece. Pull Tractor down to normal position, guiding the Ball Stud into the Socket.

Level Tractor, if necessary, according to Rear Hitch Instructions.

#### HAY RAKE

Use "LOADED" method under Lawn Roller, Transportation Cart.

#### STEERING SULKY

Bring the Steering Sulky Yoke over the outside of the Rear Hitch, lining up the holes in the Yoke with the holes in the SIDE of the Rear Hitch.

Attach with Shoulder Bolts and Elastic Stop Nuts and run down tightly. Yoke will be stable and won't work loose.

The Adjustment of the Wire Cable is critical for good operation. With the wheels in line with the frame member be sure the tension is **equal** on each strand of the Wire Cable. This is adjusted by the nuts on the ends of the threaded portion of the wire cable.

Check this tension at reasonable intervals, and keep it tight for best results.

Dual Wheels should always be used on the tractor when using the Steering Sulky.

#### RIDING SULKY

The Riding Sulky is ordinarily used with another attachment on the front, in which case the Split Socket furnished with the Rear Hitch is used.

Place the Split Socket on the Rear Hitch Ball Stud, pull the Draw Bar of the Sulky over the end of the Split Sockets, and drop the Draw Bar Pin through the holes in the Draw Bar and the Split Socket.



PLATE 54

#### 5' SEEDER SPREADER

##### ATTACHING

Attaches to the Rear Hitch with a Roller Rest Socket.

##### LUBRICATION

There is one alemite fitting on each wheel. Use Mobil-grease MP, greasing occasionally as use requires.

##### CARE OF HOPPER ASSEMBLY

The materials used in this attachment are corrosive. Abrasives are also present, which means that the protecting paint will soon wear off the port assembly and agitator. To protect these surfaces, after using your spreader wash down thoroughly and let dry, preferably in the sun. If you are not going to use it again within a few days, pour a small quantity of Mobiloil along the port openings, and work the lever which actuates the ports to distribute the oil.

##### OPERATION

Obtaining the proper distribution of the material used in the Seeder-Spreader is easy. The plate on the hopper is self-explanatory. Setting the Port Lever Opening to the proper opening will give the distribution per 10,000 square feet as noted on the plate.

##### SPECIAL INSTRUCTIONS AVAILABLE

Some Gravely attachments are not covered by the instructions in this manual. In most cases, special instructions are packed with the attachment. If additional instructions are needed, they are available on request.

## GRAVELY EQUIPMENT RECORD

Tractor Serial Number.....Tractor Mfg. Number.....  
 Identifying Markings other than above:.....  
 Carb. Model No.....Mag. Model No.....  
 Purchased from:.....  
 Service Phone Number.....

#### EQUIPMENT LIST

| DESCRIPTION | MODEL NO. | DESCRIPTION | MODEL NO. |
|-------------|-----------|-------------|-----------|
|             |           |             |           |
|             |           |             |           |



## ACCESSORIES FOR YOUR GRAVELY

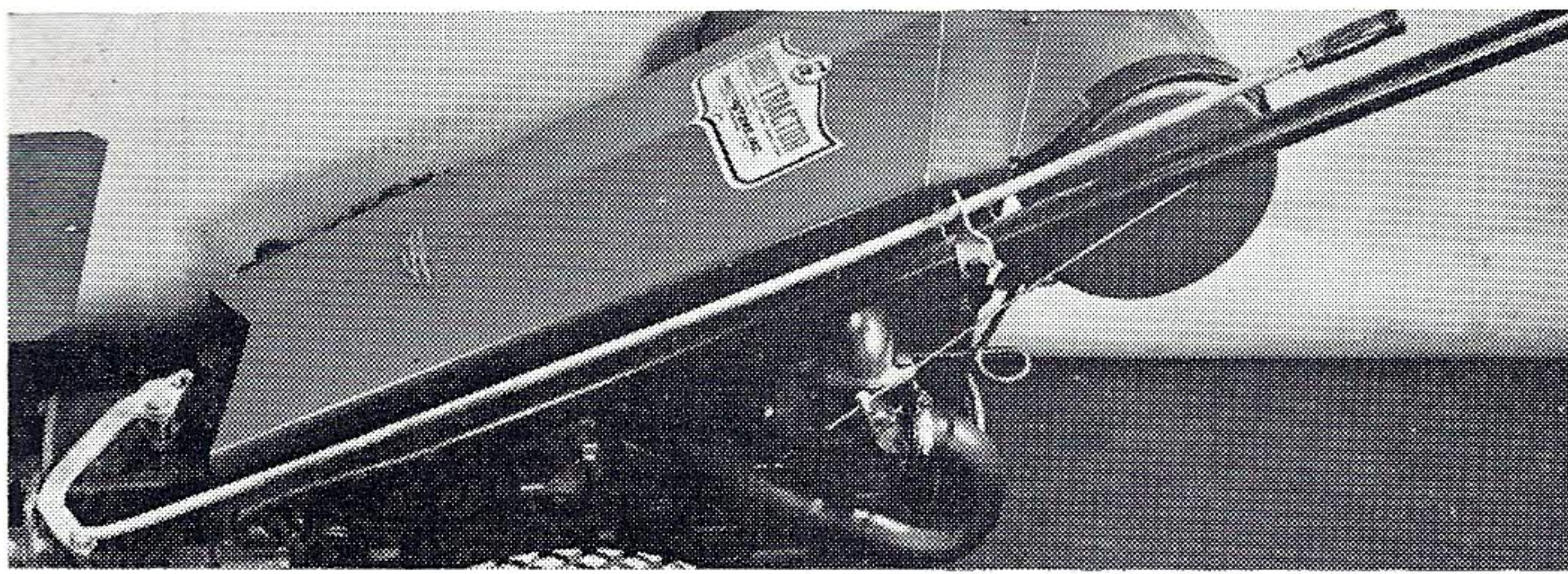

PLATE 55

### ATTACHMENT CLUTCH CONTROL

You engage and disengage your Attachments much easier with the Gravelly Attachment Clutch Control. The Control, mounted along the left Tractor Handle, allows you to engage and disengage the Attachments without leaving your position behind the Tractor.

The Attachment Clutch Control Kit can be installed quickly and easily in a few minutes.

### GOVERNOR

The Gravelly Governor will make much of your operation easier by feeding the fuel as required, **automatically!** It's like having an extra hand—especially useful in plowing and mowing where the load on the Engine varies so rapidly.

In addition to convenience, the Governor is good for your Tractor—it prevents racing of the Motor, always sees—automatically—that the correct amount of fuel is being fed to handle the load!

### OIL PRESSURE GAUGE

The Oil Pressure Gauge is an optional attachment that soon pays for itself in more convenient operation. Instead of lifting off the Oil Filler Cap to check the Oil Pump, simply check the Gauge!

### TRACTOR COVER

The Gravelly Tractor Cover is specifically designed to protect your tractor from weather, fire and water damage, and tampering. It is built to last... constructed of fire-proof, mildew-proof, waterproof, heavy duck with reinforced gromets, edges and cutouts.

The Cover fits snugly down over the handles and reaches entirely to the floor or the ground.

### TIRE CHAINS

You will need Chains when using your Tractor for Snow removal, especially when there is a thin glaze of ice under the snow. The Gravelly Chains are easily put on or taken off, and will give you the extra traction you need.

### SICKLE GRINDER

The Gravelly Sickle Grinder is a necessity if you do much mowing with your Sickle Mower. The Grinder comes equipped with a 3" Cone the correct bevel to sharpen your 3" Sickle Knives exactly right... and sharp knives are necessary for efficient mowing.

2" cones are also available for 2" sections. Specify which is desired when you order.

Full instructions for use are packed with each Grinder.

### TRACTOR STAND

The Tractor Stand makes changing attachments even easier. Quickly adjustable height, it supports the tractor while you change attachments. Ask your Gravelly representative about the Tractor Stand.

### HANDLE STOP SWITCH

An optional, inexpensive Handle Stop Switch lets you stop the motor by flipping a lever on the handle. Inexpensive, easy to install yourself.

## POWER BARROW

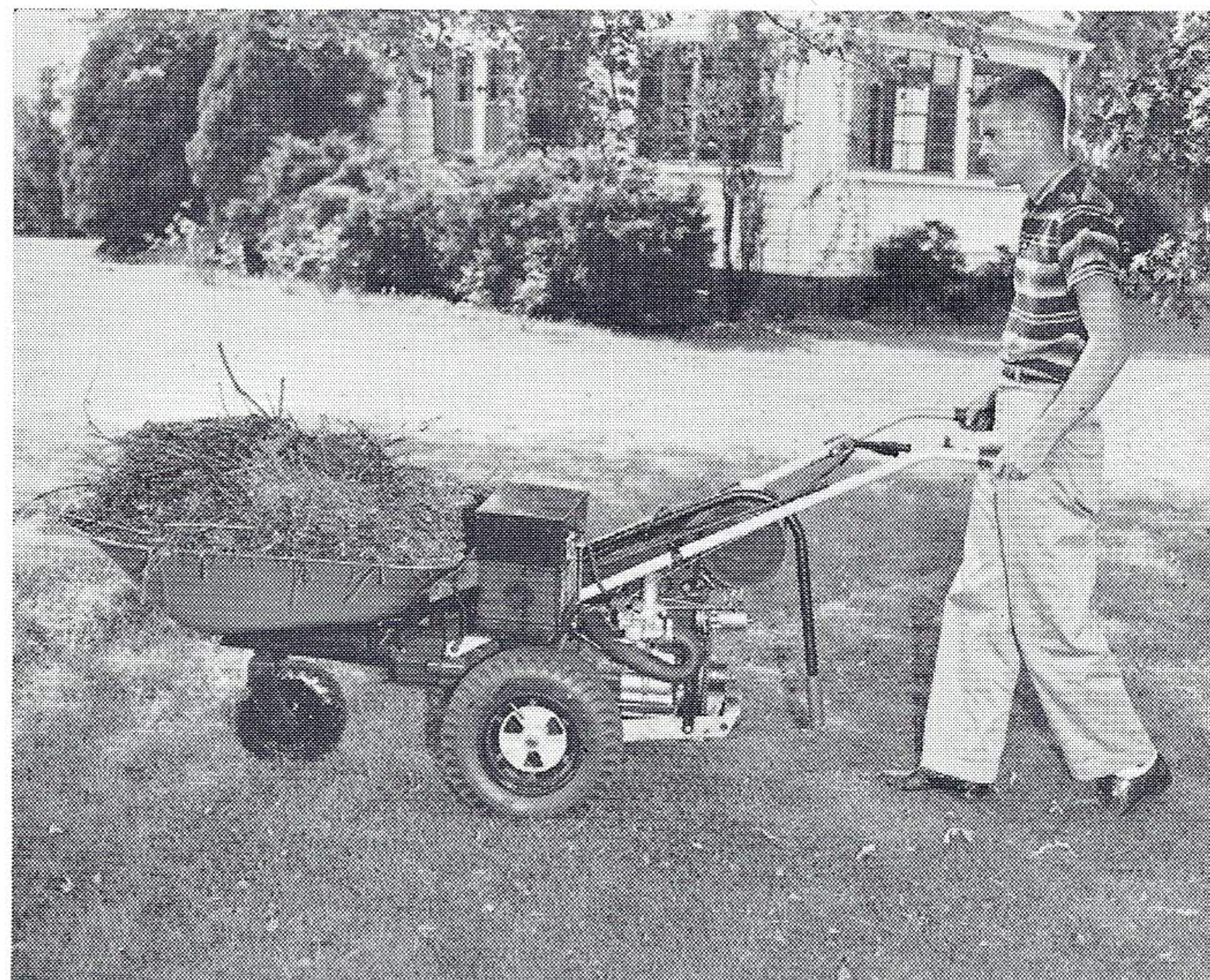

PLATE 56

This NEW Gravelly attachment is designed to make the heavy hauling tasks fast and easy. The design gives you maximum traction, handles heavy loads to the capacity of the hopper.



PLATE 57

### ATTACHING

The Power Barrow attaches by four bolts to the front of the Tractor.

### OPERATION

See illustrations above. Dumping is simply a matter of raising the handle as shown... the hopper is so balanced that this is an easy task. The odd shape of the handles allows you to accomplish this from the Tractor handles.

### LUBRICATION

There is an alemite fitting in the wheel, and one on the Caster itself. These require a shot of Mobilgrease MP from time to time.

### SIDE MOUNT BATTERY BRACKET

Some customers prefer to mount their Batteries for the Starter on the side of their Tractor instead of in the front, with the necessary hardware and cables. Required for Power Barrow.



# USE-MULTIPLIER TOOLS

For your convenience, the Gravelly Company has made arrangements with other reputable manufacturers for furnishing additional tools to help you make the most of Gravelly Equipment.

Some of these tools are illustrated on this page.

The "Use-Multiplier" attachments have been carefully adapted to Gravelly Equipment. They are guaranteed by their manufacturers under their usual guarantee.

These attachments will expand and multiply the number of jobs that Gravelly can make easier, do better for you.

Let us send you our booklet, the "Gravelly Use-Multiplier," FREE, without obligation. Full information, specifications, prices for each of these attachments—and others—are included.

A post card will do—or ask your Gravelly Dealer for your copy.

## POWER VS. DRUDGERY

From time to time new attachments and improvements are made in Gravelly Equipment. We suggest you keep your Gravelly catalog — "Power Vs. Drudgery" — handy, and look it over from time to time. You will find other Attachments that will make your jobs faster, easier—and get the job done better!

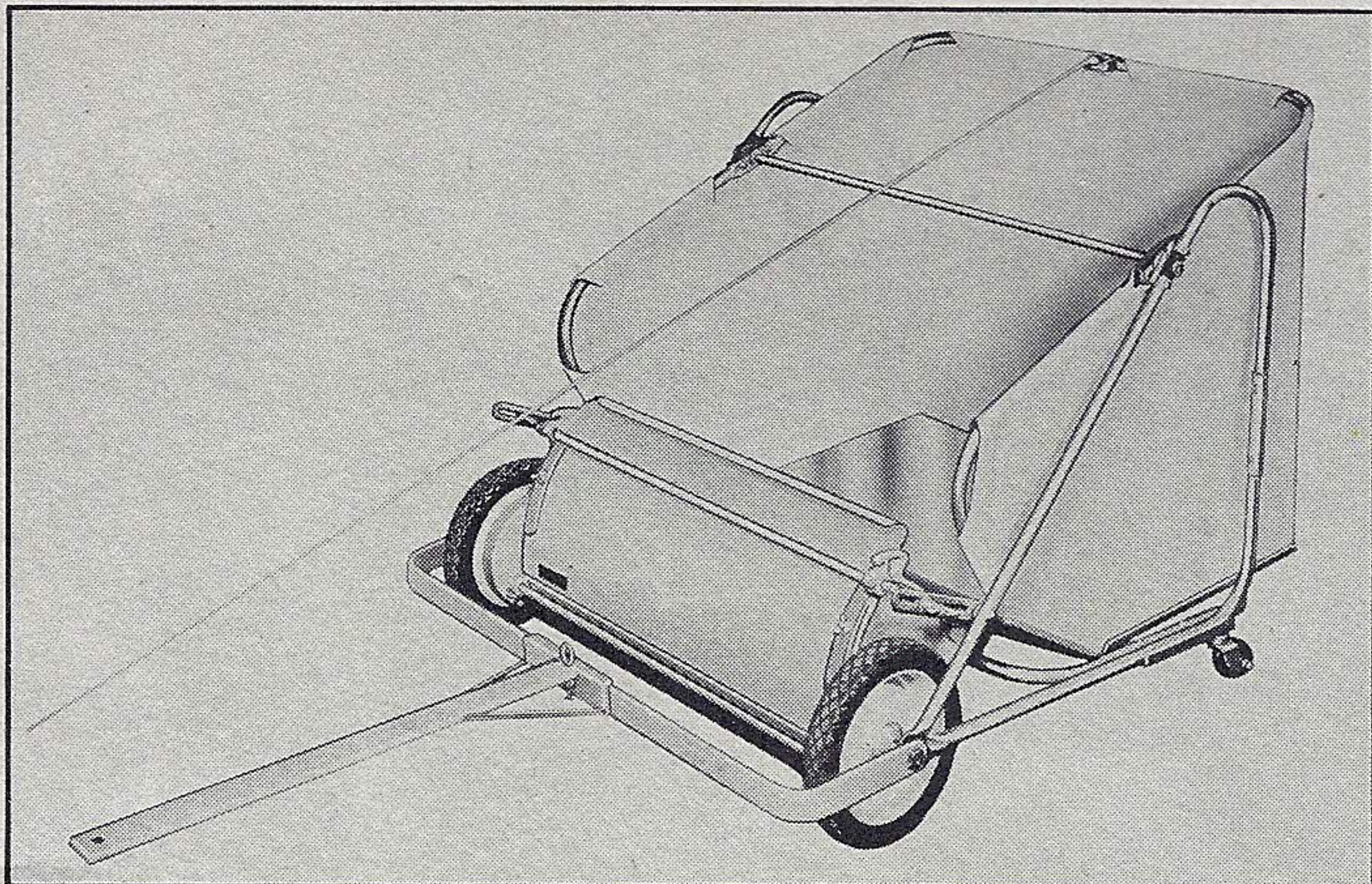

LAWN SWEEPER

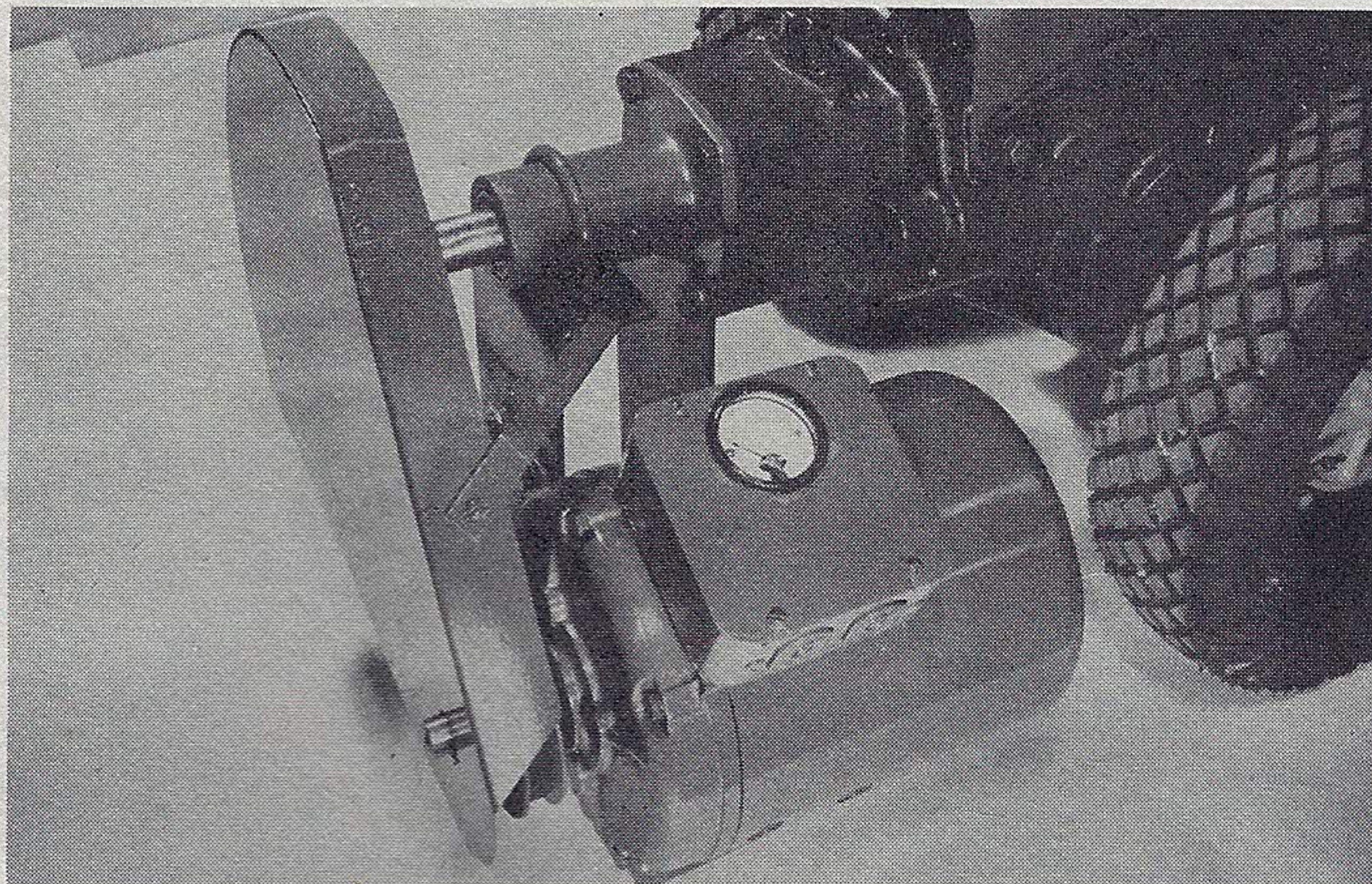

GENERATOR



BLITZ FOGGER

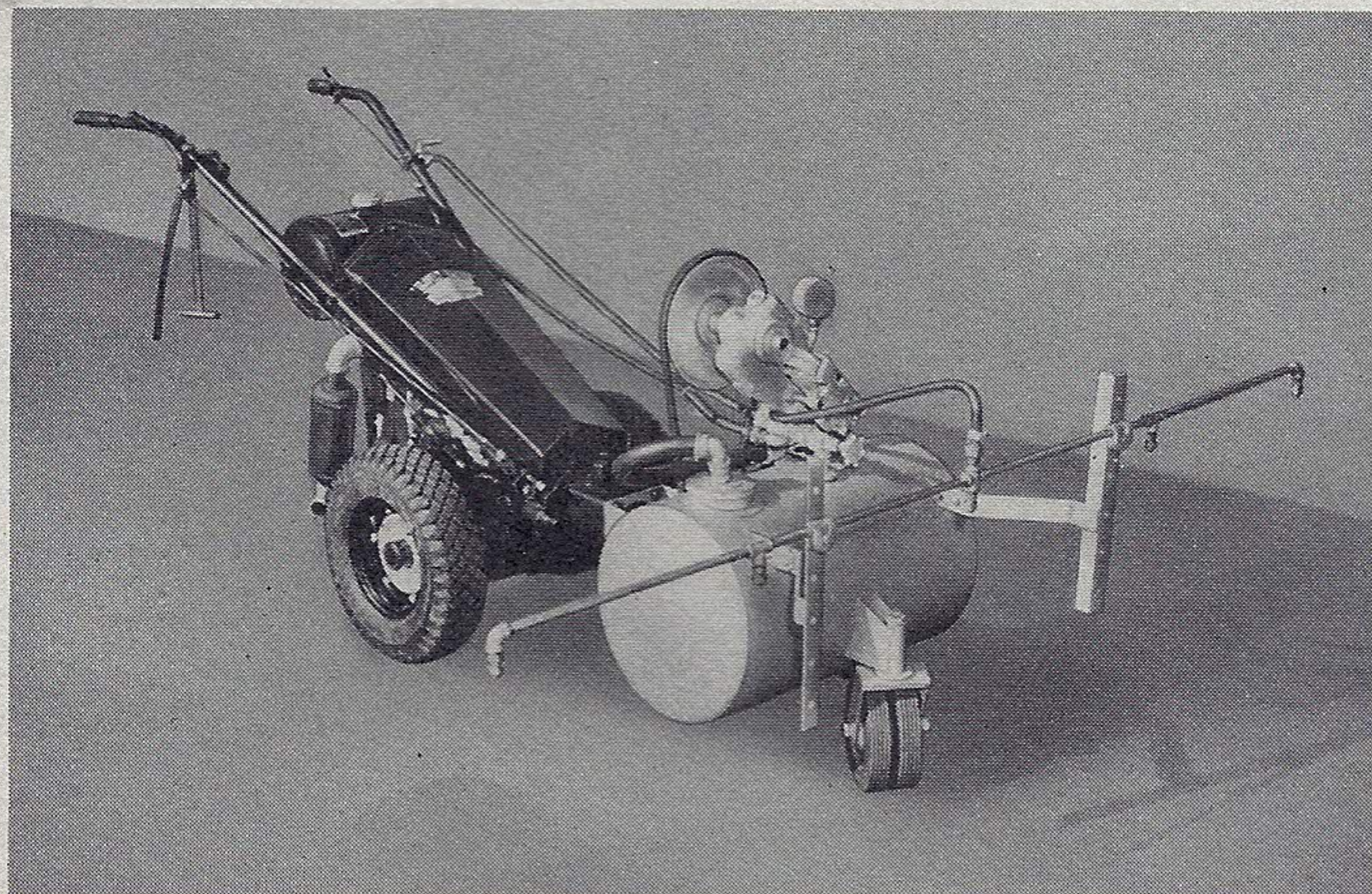

15 GALLON SPRAYER

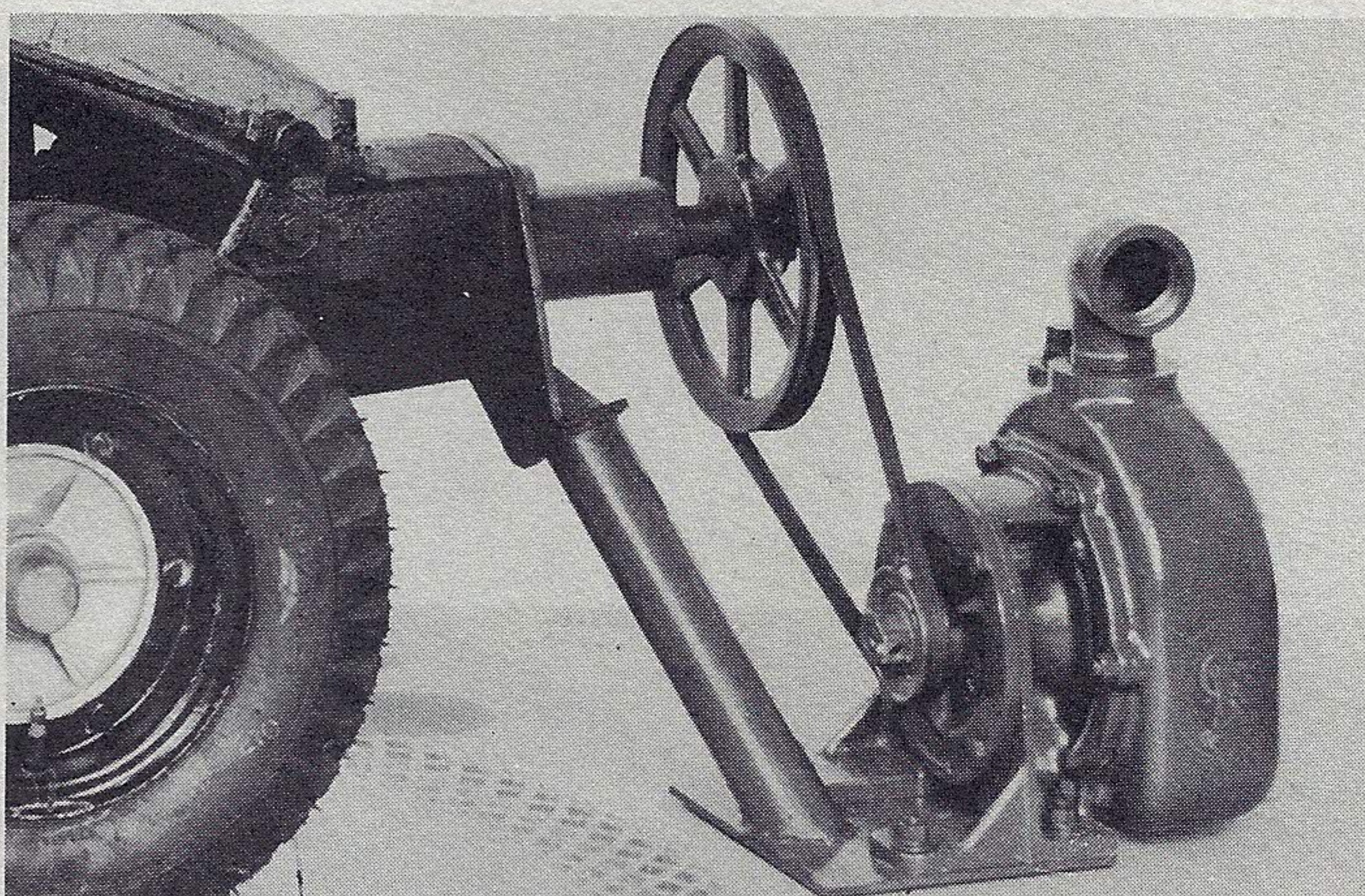

UTILITY PUMP



# **GRAVELY**

## **Quick-Check Lubrication Chart**

**TRACTOR ENGINE:** Summer Mobiloil A (SAE 30) or Mobiloil Special (10W-30)  
Winter Mobiloil Arctic (SAE 20W) or Mobiloil Special (10W-30)

**ATTACHMENTS: GEAR HOUSINGS:**

Summer: Mobiloil 140 (SAE 140)

Winter: Mobiloil 90 (SAE 90)

**GREASE FITTINGS:** Mobilgrease MP (# 2 Cup Grease)

**OIL BATH AIR CLEANER:** Mobiloil A (SAE 30)

### **CHECK!**

**TRACTOR LUBRICATION:** EVERY DAY BEFORE STARTING JOB. If not up to oil level plug, add until oil BEGINS to run out Oil Level Hole. DO NOT ADD MORE OIL AFTER OIL IS LEVEL WITH TOP OF OIL LEVEL HOLE.

**OIL BATH AIR CLEANER:** EVERY FOUR HOURS. Clean and change oil if dirty.

**DRY TYPE AIR CLEANER:** Check Every Four Hours. Change if dirty. DO NOT PUNCH OR JAB PAPER CARTRIDGE.

**ATTACHMENTS:** Mowing Attachments: Gear Housings every four hours. Others: every eight hours. Governor: Every 16 hours.

**CHANGE OIL!** For very dusty, dirty conditions, every 20 hours is best, every 40 hours a must. Drain oil while hot. For ordinary conditions, every 40 hours. Change Oil Filter according to directions on filter. For best results, replace Filter every 80 hours.

**Be Sure to Mail Your Guarantee Registration Card!  
Parts and Price Lists Available on Request**