

MAINTENANCE

First 20 Hrs. operating

Change engine oil

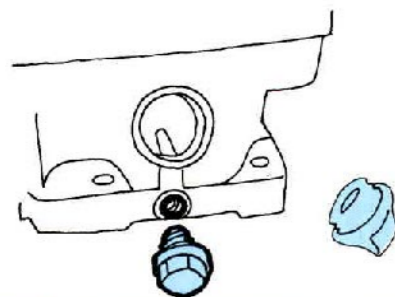

Change reduction gear oil.

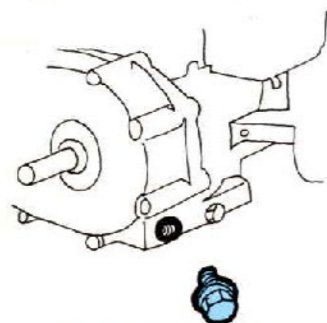

Every 50 Hrs. operating

Clean element and re-oil air cleaner.

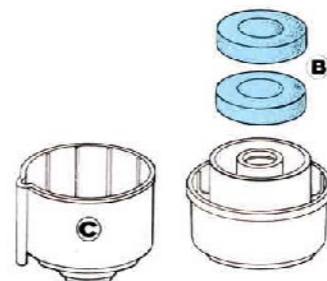

- Clean more frequently if operating in dusty area.

- Wash "B" and "C" in cleaning solvent, after drying, refill with clean engine oil up to oil level mark.

Every 100 Hrs. operating

Change engine oil

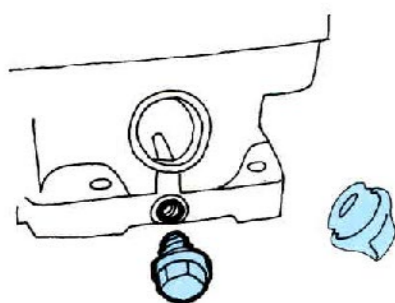

Clean fuel strainer.

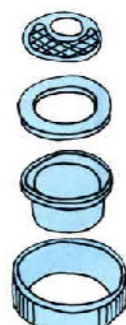
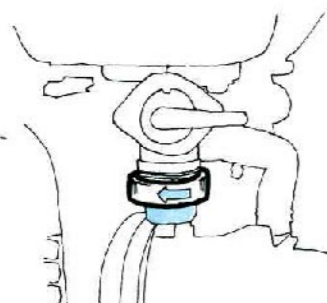

- Wash removed parts in gasoline, dry them thoroughly and install securely. (No smoking and No open flame when cleaning)

Clean spark plug and check gap.

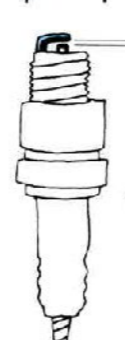

0.6 ~ 0.7 mm
(0.024 ~ 0.027 in.)

- Use NGK B6HS or BR6HS spark plug.

Every one year or 300 Hrs. operating.

Change reduction oil.

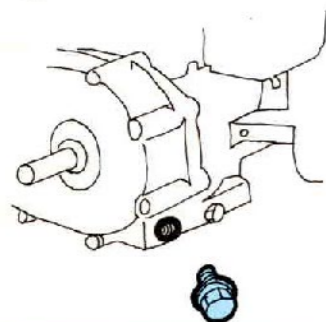

- Renew fuel tube, if necessary.
- Valve tappet clearance checking and adjustment, combustion chamber cleaning and ignition timing adjustment should be serviced by an authorized HONDA dealer, unless the owner has proper tools and is mechanically proficient.
- If you have any questions concerning the operation or serving of the engine, please contact the HONDA power products dealer whom you purchased the unit.

Before extended storing

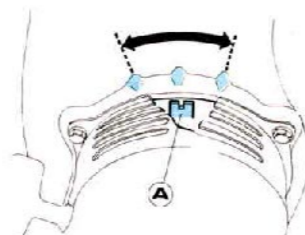

- Position mark "A" on starter pulley between by pulling starter rope.
- Drain fuel tank and carburetor.
- Change engine oil and reduction gear oil.
- Cover engine with plastic sheet.
- Store in a dry, dust-free area.

SPECIFICATIONS

		G42	G50
Cycle, Valve arrangement		4 cycle, side valve	
Displacement	cc (cu. in.)	171 (10.4)	187 (11.4)
Max. output	PS/rpm	4.5/4000	5.0/4000
Rated output	PS/rpm	3.3/3600	3.8/3600
Max. torque	kg-m	0.85	0.92
Fuel consumption	g/PS-H	300	300
PTO shaft rotating direction		Counterclockwise	
Dry weight	kg (lbs.)	19.0 (41.9)	19.0 (41.9)

* These specifications may be changed without notice.



HONDA G42-G50

GENERAL PURPOSE ENGINE

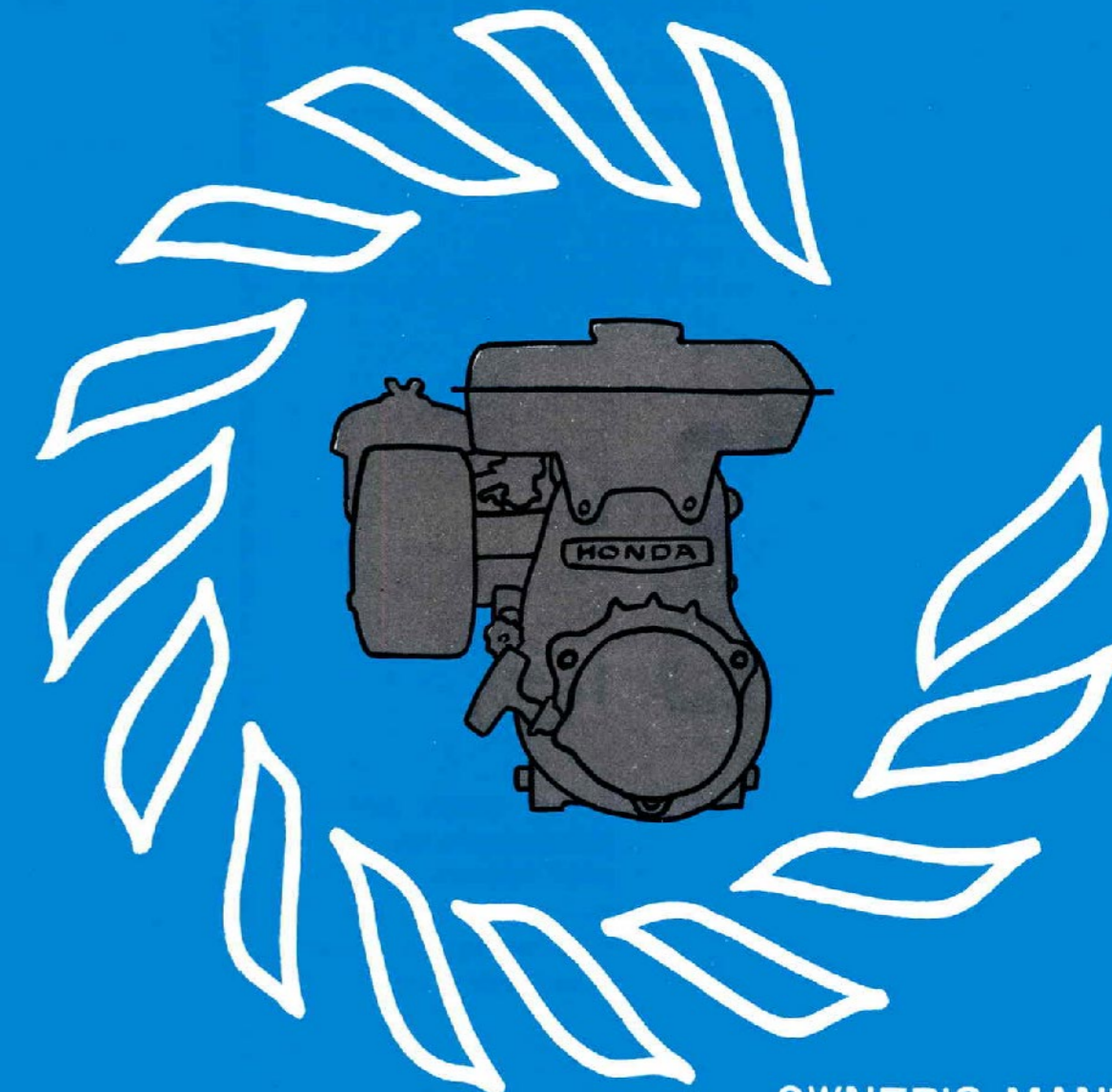

FOR SAFE OPERATION

★ Keep the engine at least 1 m (3 ft) away from building or other equipment during operation.

★ Do not place inflammable objects, such as, gasoline, matches, etc., close to the engine, while it is running.

- WARNING:**
- * Gasoline is flammable and explosive under certain conditions.
 - * Always stop the engine and do not smoke or allow open flames or sparks near the engine when refueling.
 - * Do not overfill the tank. There should be no fuel in the filler neck.
 - * If fuel is spilled, wipe it off completely before starting.
 - * Make sure that the filler cap is closed securely.

★ Operate the engine only on a level surface, otherwise fuel may spill from the fuel tank and engine lubrication may not be sufficient.

★ This engine is not equipped with a spark arrestor.

Operation on forest covered, brush covered, or grass covered land may not be legal in some sates.

Check local laws and reguration before operation.

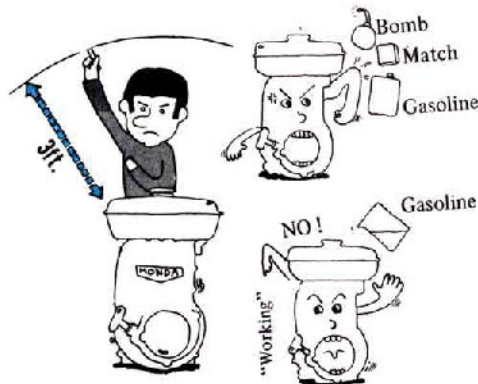

- WARNING:**
- * Exhaust contains poisonous carbon monoxide gas.
 - * Avoid inhalation of exhaust gases.
 - * Never run engine in a closed garage or confined area.

PRE-OPERATION CHECK

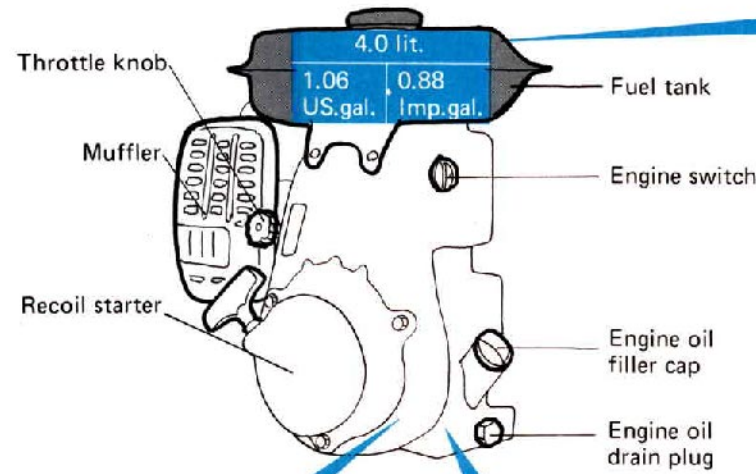

Fill fuel tank.
Use low or non-lead
"Automobile gasoline"

Check oil level and condition.



0.60 lit.
1.27 US.pt. 1.06 Imp.pt.

Engine oil
Reduction gear oil
Air cleaner oil } Use SAE 10W - 30
or 10W - 40 engine oil.

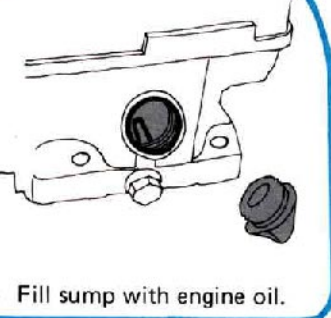

Check reduction gear oil level.

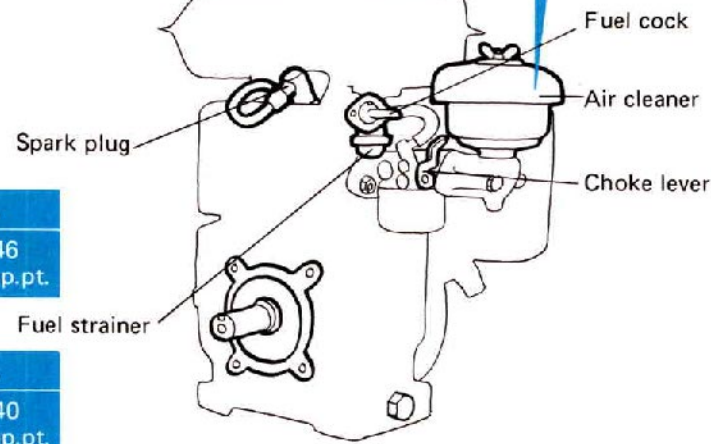
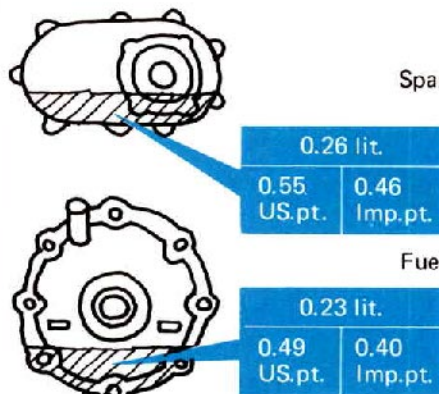

STARTING

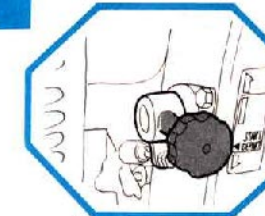
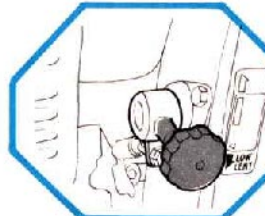
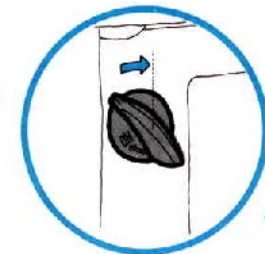

RUNNING

STOPPING

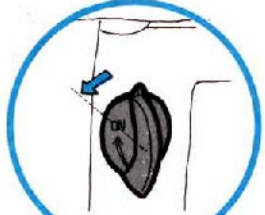
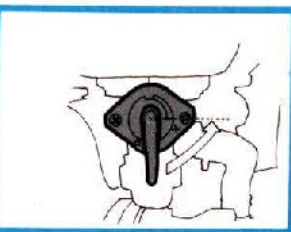
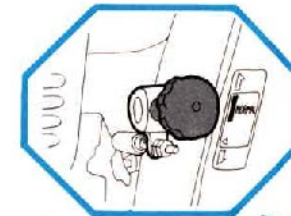

As engine warms up,
open choke lever
gradually.

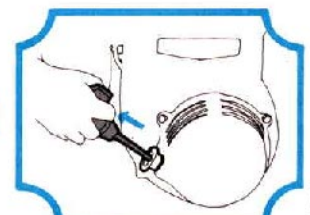

Current customer service contact information:

Servicing dealership personnel are trained professionals. They should be able to answer any question you may have. If you encounter a problem that your dealer does not solve to your satisfaction, please discuss it with the dealership's management. The Service Manager, General Manager, or Owner can help. Almost all problems are solved in this way.

United States, Puerto Rico, and U.S. Virgin Islands:

If you are dissatisfied with the decision made by the dealership's management, contact the Honda Regional Engine Distributor for your area (www.honda-engines.com/dea.htm).

If you are still dissatisfied after speaking with the Regional Engine Distributor, you may contact the Honda Office as shown.

American Honda Motor Co., Inc.
Power Equipment Division
Customer Relations Office
4900 Marconi Drive
Alpharetta, GA 30005-8847

Or telephone: (770) 497-6400 M-F, 8:30 am - 7:00 pm EST

When you write or call, please provide the following information:

- Equipment manufacturer's name and model number that the engine is mounted on
- Engine model, serial number, and type
- Name of the dealer who sold the engine to you
- Name, address, and contact person of the dealer who services your engine
- Date of purchase
- Your name, address, and telephone number
- A detailed description of the problem