

**MITSUBISHI
DIESEL ENGINE**

KATSURA
MODEL NM SERIES

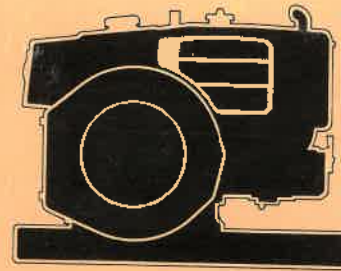

HANDLING MANUAL

'78-11



MITSUBISHI
HEAVY INDUSTRIES, LTD.

*** CORRECT OPERATION IS A VITAL KEY TO 100% PERFORMANCE**

Foreword

Thank you for buying a Mitsubishi engine.

Your Mitsubishi "KATSURA" water cooled diesel engine is the distillation of the company's experience in the design, research and production of a great variety of engines. Many excellent suggestions offered by the users also have been embodied in your engine.

To maintain your engine in top operating condition and keep it performing well up to specification, it is important that your engine is correctly operated, inspected and maintained according to this manual.

For the sake of your safety, carefully read the caution plate on your engine as well as the cautions given on pages that follow.

Should there arise questions concerning your engine or in the event of trouble, call your nearest Mitsubishi dealer authorized service shop.

Remember that the contents of the manual may slightly differ from your engine because of the use of modified parts following changes made to the specifications for better quality and performance.

For your future engine needs, please count on Mitsubishi as the supplier of the most dependable engines.

*Precautions for safe operation

1. Do not release your hold of the cranking handle until you remove the handle from the shaft.
2. On condenser cooled engines, do not open the condenser cap during operation or immediately after operation. Ejection of boiling water could be dangerous. Do not open the cap while the engine is hot.
3. Do not touch the muffler during operation or immediately after operation. It might cause burns. Avoid operating the engine near things which easily catch fire.
4. Operation in a poorly ventilated place is dangerous. Make sure that the engine is operated in a well ventilated place.
5. Do not adjust parts or add fuel during operation.
6. Cover the rotary parts to prevent operation with dangerous parts exposed.

Table of Contents

General Specifications	2
Preparations for Operation	5
Before Starting	7
Start · Operation	9
Stopping	10
How to Care the Engine after Operation	11
Storage	12
Starting the Engine during Cold Weather	13
Lighting Equipment	15
Selecting Pulleys	16
Extension Shaft installation procedure	17
Periodic Inspections and Adjustments	18
Instructions for Dyna-starter Equipped Engine	27

General Specifications

Engine Model		NM65			NM75		
		NM55H	65	65L	65H	75	75L
Type		1-cylinder, 4-cycle, water-cooled, horizontal, diesel engine					
Bore×Stroke	mm (in.)	68×80 (2.68×3.15)	73×82 (2.87×3.23)			78×85 (3.07×3.35)	
Total Displacement	cc (cu. in.)	290 (17.7)	343 (20.9)			406 (24.8)	
One hour rating out put	BHP/rpm	5.5/2400	6.5/2400			7.5/2400	
Continuous rating out put	BHP/rpm	4.5/2400	5.5×2400			6.5×2400	
Dry Weight	kg (lb)	53 (117)	61 (134)	65 (143)	74 (163)	69 (152)	
Cranking direction		Counter-clockwise, facing flywheel					
Starting System		Manual					
Cooling System		Hopper	Condenser	Hopper	Condenser	Hopper	
Cooling Water Capacity	liter (U.S.gal.)	5.2 (1.37)	1.5 (0.39)	7.0 (1.84)	1.8 (0.48)	7.5 (1.98)	
Lubrication System		Forced feed circulation by trochoid-pump with relief-valve & oil pressure signal					
Lubricant Capacity	liter (U.S.gal.)	1.1 (0.29)	1.25 (0.33)			1.8 (0.48)	
Air Cleaner		Cloth filter type, paper filter type (cyclone type) or oil bath type					
Fuel		Gas oil					
Fuel Tank Capacity	liter (U.S.gal.)	6.0 (1.58)	6.8 (1.79)	6.0 (1.58)	6.0 (1.58)		
Generating Device	(V×W)	—	Fan-dynamo (6~8×25 & 10)		—	Fan-dynamo (6~8×25 & 10)	
Head Lamp (Double Filament)	(V×W)	—	—	(6~8×25)	—	—	(6~8×25)

NM90				NM110				NM130									
90	90E	90L	90H	110	110E	110L	110H	130	130E	130L	130H						
1-cylinder, 4-cycle, water-cooled, horizontal, diesel engine																	
80×95(3.15×3.74)				88×95(3.46×3.74)				94×95(3.70×3.74)									
477(29.1)				577(35.2)				659(40.2)									
9/2400				11/2400				13/2400									
8/2400				9.5/2400				11/2400									
90(198)	105(231)	90(198)	85(187)	94(207)	109(240)	94(207)	89(196)	116(256)	136(300)	116(256)	110(242)						
Counter-clockwise, facing flywheel																	
Manual	Dynastarter	Manual		Dynastarter	Manual		Dynastarter	Manual									
Condenser		Hopper		Condenser		Hopper		Condenser		Hopper							
2.4(0.63)		12(3.16)		2.4(0.63)		12(3.16)		3.3(0.87)		14(3.70)							
Forced feed circulation by trochoid-pump with relief-valve & oil pressure signal																	
2.4(0.63)						2.8(0.74)											
Cloth filter type, paper filter type (cyclone type) or oil bath type																	
Gas oil																	
8.7(2.29)			10(2.64)			8.7(2.29)			10(2.64)			11(2.91)			12(3.16)		
Fan-dynamo (6~8×25 & 10)			—			Fan-dynamo (6~8×25 & 10)			—			Fan-dynamo (6~8×25 & 10)			—		
—			(6~8×25)			—			(6~8×25)			—			(6~8×25)		

General Specifications

Engine Model		NM155				NM180			
		155	155E	155L	155H	180	180E	180L	180H
Item		1-cylinder, 4-cycle, water-cooled, horizontal, diesel engine							
Type		1-cylinder, 4-cycle, water-cooled, horizontal, diesel engine							
Bore×Stroke	mm (in.)	96×110(3.78×4.33)				100×110(3.94×4.33)			
Total Displacement	cc (cu in.)	796(48.6)				863(52.7)			
One hour rating out put	BHP/rpm	15.5/2400				18/2400			
Continuous rating out put	BHP/rpm	13/2400				15/2400			
Dry Weight	kg (lb)	147(324)	166(366)	145(320)	139(306)	152(335)	171(377)	150(331)	144(317)
Cranking direction		Counter-clockwise, facing flywheel							
Starting System		Manual	Dynastarter	Manual		Dynastarter	Manual		
Cooling System		Condenser			Hopper	Condenser			Hopper
Cooling Water Capacity	liter (U.S.gal.)	4.8(1.27)			16.5(4.36)	4.8(1.27)			16.5(4.36)
Lubrication System		Forced feed circulation by trochoid-pump with relief-valve & oil pressure signal							
Lubricant Capacity	liter (U.S.gal.)	3.3(0.87)							
Air Cleaner		Paper filter type (cyclone type) or oil bath type							
Fuel		Gas oil							
Fuel Tank Capacity	liter (U.S.gal.)	13.5(3.57)			12(3.16)	13.5(3.57)			12(3.16)
Generating Device	(V×W)	Fan-dynamo (6~8×25 & 10)			—	Fan-dynamo (6~8×25 & 10)			—
Head Lamp (Double Filament)	(V×W)	—	—	(6~8×25)	—	—	—	(6~8×25)	—

Preparations for Operation— When making preparations for operation, observe the following procedure.

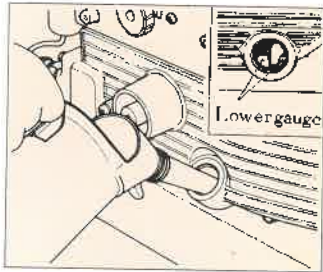

① Filling crankcase with oil

Prior to operation, place the engine in level position and fill the crankcase with oil up to the vicinity of the filler port located under the cranking shaft.

Oil quantity;

Please see page General specification.

Make sure that the recommended brands of engine oil are used. (Please see page 32)

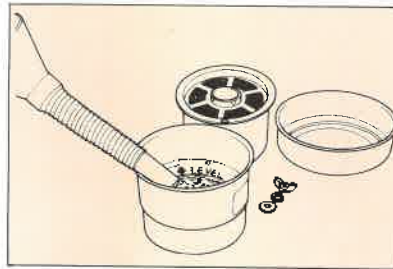

② Filling air cleaner with oil (for oil bath type)

Refill up to the prescribed oil level of the cleaner case. The oil should not be above or below the prescribed level.



③ Adding fuel

Fill the fuel tank with Mitsubishi diesel heavy oil or Gas oil. Make certain that the fuel is added through a strainer.

The use of a fuel containing foreign substances might ruin the performance of the engine and even might cause damage to the injection pump which is the heart of the engine.

Tank capacity;

Please see page General specification.

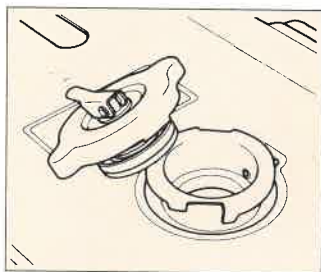

④a Adding coolant
(for condenser-cooled type)

Remove the pressure cap at the top of the condenser and slowly put in water. Make sure that a soft water is used. Fill up to the filler port, use care to prevent entry of sand or rust into the condenser.

Coolant capacity;

Please see page General specification.

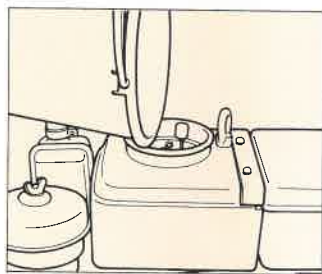

④b Adding coolant
(for hopper-cooled type)

Add soft water through a dust strainer until the float slightly floats up.

After the engine has gone into full operation and the water has begun to boil, add water.

Coolant capacity;

Please see page General specification.

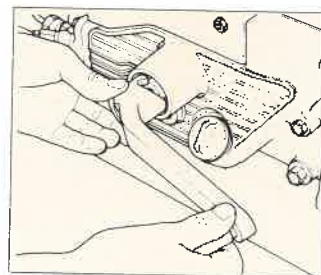

⑤ No-load cranking

Before starting, be sure to crank the engine at no load. Remove the cranking handle from its holder, insert it onto the cranking shaft, and crank the shaft at no load, while depressing the decompression lever, to spread oil through the engine. An engine released from service for a long period should be cranked at no load approx. 20 times. If you have been operating the engine every day, crank it approx. 10 times.

Before starting

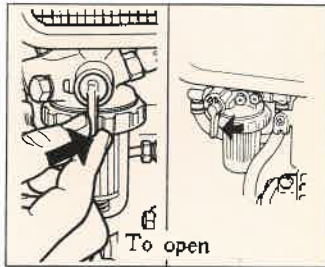

⑥ Operating fuel cock (for filter with cock)

Open the fuel filter cock.
The fuel is delivered to the
injection pump past the fuel
filter.

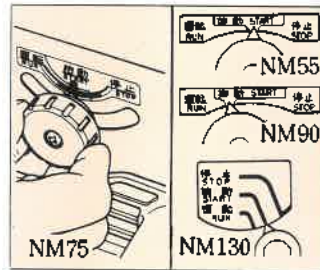

⑦ Setting control lever

Set the speed control lever to
the START position.

⑧ Operating fuel button (for Model NM130~180)

Depress the starting fuel button
located on the fuel injection
pump.

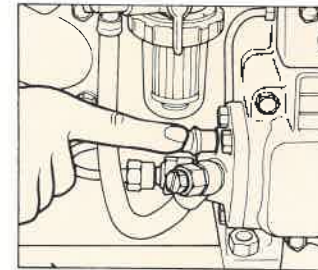

Note

It is not necessary to depress
the fuel button when the atmo-
spheric temperature is high or
when the engine is warm.

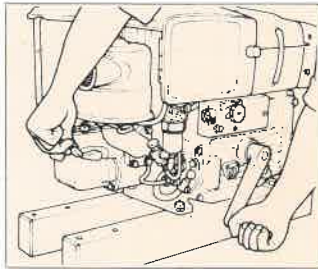

⑨a Confirming fuel injection noise (for Model NM55~110)

While holding down the decompression lever with your left hand, turn the cranking handle with your right hand to confirm fuel injection noise. (If no injection noise is heard, bleed the fuel system as described below.)

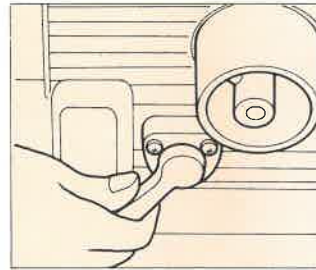

⑨b Confirming fuel injection noise (for Model NM130~180)

Turn the flywheel until the priming lever feels heavy to the hand. In this state, move the priming lever about 20 times, making certain of the injection noise. If no injection noise is heard, bleed the fuel system as described below.

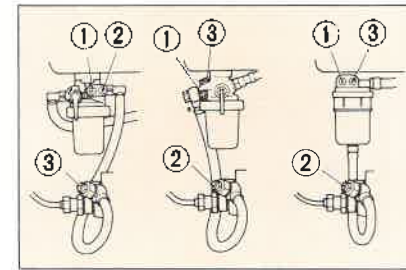

⑩ Bleeding

If no injection noise is heard at the time of the first operation or usual starting, bleed the fuel system.

Loosen the air vent screws 1, 2 and 3 shown in the illustration in that order to let the fuel run out until no air bubbles are present.

After the fuel system has been bled, tighten the screws firmly.

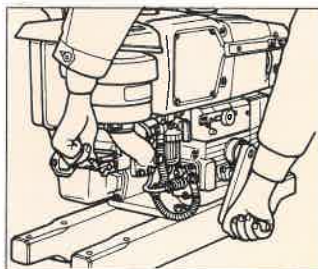

① Starting with decompression lever held down

Rotate the cranking handle to check to ensure that the engine is on the compression stroke or that the handle is placed in the position it is to be turned upward. Hold down the decompression lever and turn the cranking handle with force.

If the engine has gained sufficient inertia, release the decompression lever but continue to turn the cranking handle with additional force until the engine starts up. After the engine has started up, secure the handle in its holder.

◎ Starting precautions

1. Make certain that the cranking handle is securely fitted into the pin of the cranking handle.
2. Take a correct attitude when starting the engine.
3. Be sure not to release your hold of the handle when starting. If you let go your hold of the handle, it could be very dangerous, because the handle rotates with the shaft. The handle will automatically come out of position as soon as the engine begins to start.

⑫ Warmup operation

Allow approx. 5 to 10 minutes for warmup operation after starting. Check to see if the oil signal is correctly performing (blue). After warmup operation, place load at a desired speed. Note: Check points and precautions "during operation" under Daily Inspection (Page 21) should also be referred to.

~~~~~ Operating a new engine

When a new engine is to be operated, allow the first week (approx. 30 hours) for break-in operation. Operate it at moderate speeds carefully to avoid overloading.

~~~~~

## Stopping

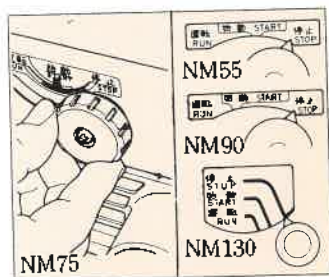

### ⑬ Shutting down with speed control lever

Set the speed control lever to the **STOP** position to shut down the engine.

#### Caution

Do not use the decompression lever in shutting down the engine.

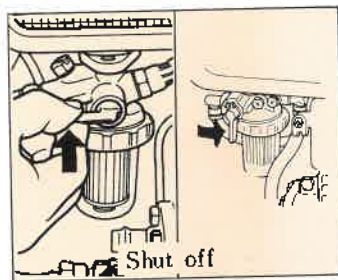

### ⑭ Operating fuel cock (for filter with cock)

Turn the fuel filter cock lever upward to shut off the fuel.

# How to Care the Engine after operation

## 1. Removing coolant

After operation, be sure to open the drain cock lever and then stand the pressure cap lever (for condenser-cooled type) to remove water while the engine is still hot. Even some water that may be left behind will be evaporated by the engine heat so that every part can be kept dry. when draining a condenser cooled engine refer to the precautions during operation under Daily Inspection to insure safety.

## 2. Cleaning

Thoroughly clean the engine. Cleaning does not merely mean wiping away dust. It will help you to find loosened bolts if any and prevent troubles well in advance. So do not neglect cleaning.

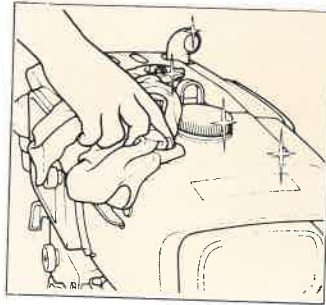

## \* Storage for a long period

When the engine is to be stored for a long period, take the following steps to aid in next time startup. Store the engine in a clean and dry place.

### 1. Applying oil to cylinder to prevent rust

Remove either the nozzle holder or air cleaner, put in a small amount of fresh oil in the cylinder, and turn the cranking handle several times. If the nozzle holder was removed, tighten the bolts evenly. If the air cleaner was removed, tighten the cleaner firmly.

### 2. Placing piston on compression stroke

Place the flywheel at a position 40° to 50° before the top dead center on the compression stroke. For this purpose, turn the flywheel to a point before the compression stroke, hold down the decompression lever, and turn the flywheel coincides with the arrow mark on the tank (NM55H to 65) or until the mark on the crankcase coincides with the indicator (NM75 and above). On engines with a cover over the flywheel, hold the flywheel at a position where the inspection window of the cover and the IT mark of the flywheel coincide.

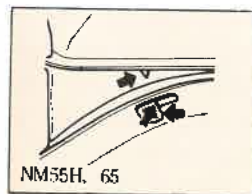

With flywheel cover

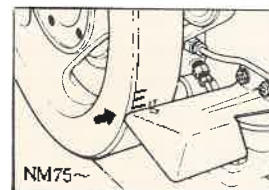

With indicator

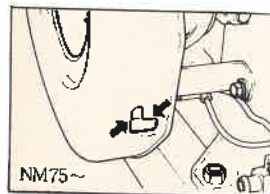

With flywheel cover

### ⊙ Storage precautions

Check for fuel leaks before storage. To prevent the danger of fire, store the engine after it has cooled down.

## Starting the Engine during Cold Weather



To facilitate starting in cold weather, proceed in the following sequence.



### ① Engine oil

The use of high viscosity oil in cold weather will offer large resistance to manual cranking. Poor acceleration will result in hard engine starting. So the use of the CB or higher grade oil of low viscosity is recommended. A recommended brand of oil SAE 10W-30 in viscosity should be used.

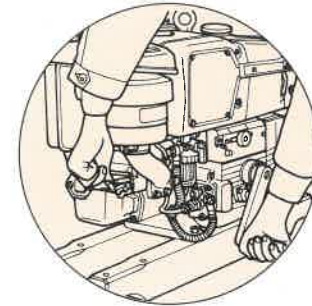

### ② Manual cranking

Hold down the decompression lever and turn the cranking handle to spread oil through the engine. Try to turn the handle more often than usual, particularly in cold weather.



## Starting the Engine during Cold Weather



### ③ Checks to make before starting

Check for complete fuel injection on the basis of the injection noise which will be heard when the cranking handle is turned with the decompression lever held down. If no injection noise is heard, bleed the fuel system. Check also for complete compression.



### ④ Heating coolant and oil

For cold weather starting, heat the water and oil in separate containers. This will make starting a lot easier.

#### ⊙ Caution

When the oil is heated, use care to prevent fire.

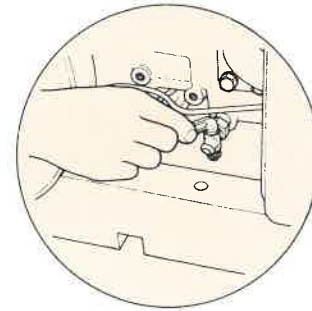

### ⑤ Removing coolant

Be sure to remove the coolant after a day's operation. If it is frozen at night, the engine might be ruined. The use of antifreeze in the coolant, however, will eliminate icing trouble.

## Lighting Equipment (for Condenser type)

On headlamp equipped engines, switchover of the headlamp and work lamp can be made with a remote switch attached to the handle of a tiller. To facilitate electrical connections, the leads for the lighting system are centralized on the speed control guide plate.

Connections can be made easily as shown.

### 1. When the engine is to be used with a tiller

Make connections as shown below for switchover of the lamps at the handle of the tiller.

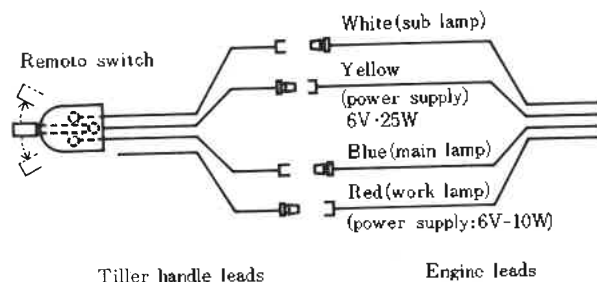

### 2. When the engine is to be used independently

Connect the leads as shown.

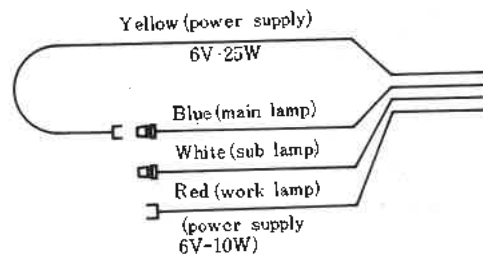

Engine leads

## Selecting Pulleys.

Belt pulleys (80mm) are available on order but when the engine is used for a special type of machine, it may be necessary to change the engine pulley or the pulley of the work machine. To select a proper pulley, calculate its diameter by the following formula.

### 1. Changing engine pulleys

Engine pulley diameter (D) = Work machine pulley diameter (d)  $\times$   $\frac{\text{Work machine speed (n)}}{\text{Engine speed (N)}}$

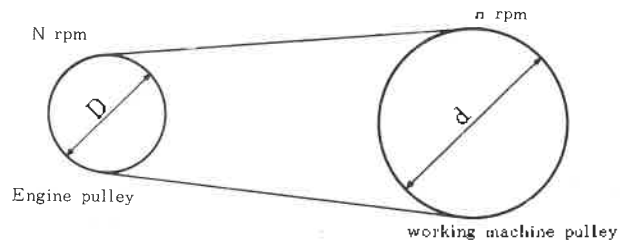

### 2. Changing work machine pulleys

Work machine pulley diameter (d) = Engine pulley diameter (D)  $\times$   $\frac{\text{Engine speed (N)}}{\text{Work machine speed (n)}}$

An engine speed which would not overload the engine should be selected in consideration of the work machine.

## Extension Shaft installation procedure

### ⊙ Cautions

When you select any of the pulleys described below, please consult with your nearest Mitsubishi dealer or the company.

1. A pulley whose belt contacting angle ( $\theta^\circ$ ) is less than  $120^\circ$
2. A pulley not between 100 and 250mm diameter ( $D\phi$ ) (Extremely small or large pulley)
3. A pulley whose overhang ( $L$ ) exceeds 150mm

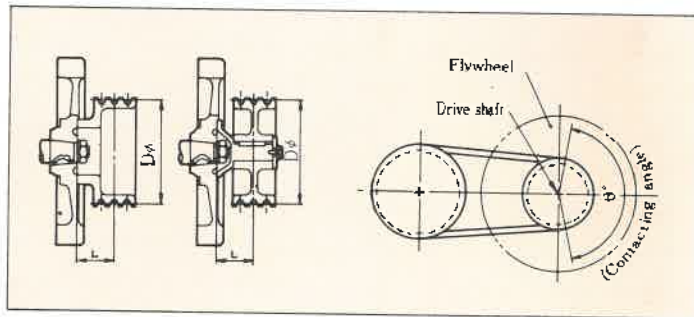

The use of the engine for industrial purposes will make it necessary to select a pulley of suitable size. An extension shaft for this purpose is available from your nearest Mitsubishi dealer. Tighten the extension shaft to the flywheel with three bolts inserted from outside the joint. On the General Power engine, an extension shaft is standard equipment.

# Periodic Inspections and Adjustments

○ Inspection    △ Adjustment    □ Cleaning    ⊙ Replacement    ● Refilling    ▲ Drain

| Inspection and adjustment intervals               | At the time of delivery             | Daily        |                  |                 |
|---------------------------------------------------|-------------------------------------|--------------|------------------|-----------------|
|                                                   |                                     | Before start | During operation | After operation |
| Each tightened part                               | ○                                   |              |                  | ○               |
| Appearance                                        | ○                                   |              |                  | □               |
| Engine oil                                        | ●                                   | ○            |                  |                 |
| Air cleaner                                       | cloth filter type                   |              |                  |                 |
|                                                   | paper filter type<br>(cyclone type) |              |                  |                 |
|                                                   | oil bath type                       | ●            | ○                |                 |
| Fuel                                              | ●                                   | ●            |                  |                 |
| Cooling water                                     | condenser type                      | ●            | ●                | ▲               |
|                                                   | hopper type                         | ●            | ●                | ▲               |
| Fan belt tension(except hopper type)              | ○                                   |              |                  |                 |
| Oil signal                                        | ○                                   |              | ○                |                 |
| Condition of exhaust                              | ○                                   |              | ○                |                 |
| Noise, vibration, and water, oil and gas leaks    | ○                                   |              | ○                |                 |
| Speed of revolution<br>(including hunting)        | ○                                   |              | ○                |                 |
| Headlamp and working lamp<br>(except hopper type) | ○                                   |              | ○                |                 |
| Condenser fins                                    |                                     |              |                  | □               |
| Fuel filter                                       | cartridge type                      |              |                  |                 |
|                                                   | with cock                           |              |                  |                 |
| Fuel tank                                         |                                     |              |                  |                 |
| Valve clearance                                   |                                     |              |                  |                 |
| Nozzle injection pressure                         |                                     |              |                  |                 |

○...Inspection    △...Adjustment    □...Cleaning    ⊙...Replacement    ●...Refilling    ▲...Drain

| Longtime<br>shutdown | After first<br>10 hours of<br>operation | After first<br>30 hours of<br>operation | Every 100<br>hours | Every 300<br>hours       | Every 500<br>hours | Every 600<br>hours       |
|----------------------|-----------------------------------------|-----------------------------------------|--------------------|--------------------------|--------------------|--------------------------|
| ○                    |                                         | ○                                       | ○                  |                          |                    |                          |
| □                    |                                         |                                         |                    |                          |                    |                          |
|                      | ⊙                                       | ⊙                                       | ⊙                  |                          |                    |                          |
|                      |                                         |                                         | □                  | ⊙ ELEMENT<br>Replacement |                    |                          |
|                      |                                         |                                         | □                  |                          |                    | ⊙ ELEMENT<br>Replacement |
|                      |                                         | □ ⊙                                     | □ ⊙                |                          |                    |                          |
| ▲                    |                                         |                                         |                    |                          |                    |                          |
| ▲                    |                                         |                                         |                    |                          |                    |                          |
| ▲                    |                                         |                                         |                    |                          |                    |                          |
|                      |                                         |                                         | △                  |                          |                    |                          |
|                      |                                         |                                         |                    |                          |                    |                          |
|                      |                                         |                                         |                    |                          |                    |                          |
|                      |                                         |                                         |                    |                          |                    |                          |
|                      |                                         |                                         |                    |                          |                    |                          |
|                      |                                         |                                         |                    |                          |                    |                          |
|                      |                                         |                                         | □                  |                          | ⊙                  |                          |
|                      |                                         |                                         | □                  |                          |                    |                          |
|                      |                                         |                                         |                    | □                        |                    |                          |
|                      |                                         |                                         |                    | △                        |                    |                          |
|                      |                                         |                                         |                    | △                        |                    |                          |

## Daily Inspection

### ① Before operation

#### 1. Checking engine oil level

Place the engine in level position and check the engine oil level. Add if the level is lower than halfway between the bottom of the filler port and the lower limit mark.

#### 2. Checking air cleaner oil (Oil bath type)

Check to see if the oil in the air cleaner are up to the prescribed level.

#### 3. Checking coolant level

##### a. Condenser type

If the level is lower than the vicinity of the filler port, add drinking water. Do not use river or well water which does not lather well.

##### b. Hopper type

If the level is lower than where the float slightly floats up through the strainer, add drinking water. After the engine has started up and the water has begun to boil, add more water.

#### 4. Checking fuel level

Remove the cap of the fuel tank and check the fuel level. Add if low. Make sure that fuel is added through the strainer.

### ② During operation

#### 1. Starting

After a cold engine has started, allow five to ten minutes for warmup operation at low speed (START position).

#### 2. Checking oil signal (in provided)

Check to see if the oil signal on the cover of the speed governor is properly performing (showing blue). If the signal is red, the signal is out of order or the oil level low. Stop the engine immediately and check the oil level. If the signal is defective, call your nearest Mitsubishi dealer.

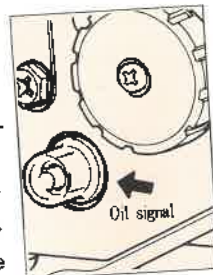

### 3. Checking exhaust emissions

Check the exhaust emissions. If the fuel is burning properly, the exhaust emissions will be colorless and transparent.

### 4. Checking for other abnormal conditions

Check for noise, water leaks, oil leaks or abnormal vibrations.

### 5. Adding coolant (hopper type)

When the engine is continuously operated as in industrial applications, check the position of the float at the intervals of one or two hours. Add if low.

## ⊙ Precautions during operation

### 1. Engine speed

Do not operate the engine at a speed higher than the standard speed.

### 2. Pressure cap

On the condenser type, do not remove the pressure cap during operation or immediately after operation. Ejection of boiling water could cause burns. Frequent removal of the cap will result in earlier reduction of the coolant. When there is a need for removing the cap, stop the engine and let it alone for more than 10 minutes. Lift the pressure lever to release the pressure completely from inside the condenser before removing the cap.

### 3. Broken fan belt

On the condenser type, a broken belt might soon result in ejection of steam from inside the condenser. Stop the engine immediately.



## Daily Inspection

### ③ After operation

#### 1. Removing coolant

Remove the coolant after operation. On the condenser type in particular, observe the precautions described under During operation.

#### 2. Cleaning and checking for looseness

Thoroughly clean the engine. When it was operated in a dusty or muddy place, clean the air cleaner as well. On the condenser type, check and clean the inside of the condenser grille and fins as well. At the same time, check to ensure that the bolts are tight and secure.

### ⊙ Precautions after operation

1. Use the speed control lever to stop the engine. Be sure not to use the decompression lever to stop the engine.

#### 2. Speed governor and allied sections.

Do not touch the speed governor and allied sections except the speed control lever.

## Inspection at Every 10 Hours Operation

### 1. Replacing engine oil

On a new engine, replace the engine oil after the first 10 hours of operation. And the engine oil should be replaced while the engine is still hot. Use the recommended brands of diesel engine oils.

#### ⊙ Caution

If the engine oil is removed when the engine is cold, dust and worn metallic powder will be deposited at the bottom of the crankcase. Such an oil change will prove to be hardly effective.

## Inspection at Every 30 Hours Operation

The moving parts of an engine will be "settled" in approx. 30 hours after the first operation. After the first 30 hours operation, check and adjust all points.

### 1. Check for looseness.

Retighten all points of the engine.

### 2. Replace the engine oil.

The engine oil should be replaced while the engine is still hot.

### 3. Cleaning air cleaner and replacing oil. (oil bath type)

Clean the interior of the air cleaner. Change the air cleaner oil with fresh oil. When the engine is used in a specially dusty place, check the air cleaner every day. Clean the interior of the cleaner and replace the oil when necessary. Remember to always keep clean the interior of the air cleaner during operation.

# Inspection at Every 100 Hours of Operation

## 1. Checking for looseness

Check the major bolts and nuts.

## 2. Replacing engine oil

Replace the engine oil while the engine is still hot.

## 3. Checking belt tension (condenser type)

Adjust the tension of the fan belt so that when the middle of the belt between the fan pulley and the intermediate pulley is depressed with the thumb, the belt will deflect approx. 12mm. For adjustment, loosen the tightening nut of the intermediate pulley shaft and move the intermediate pulley with the tension bolt to correct the belt tension. After the adjustment, make sure that the pulley tightening nut is firmly tightened.

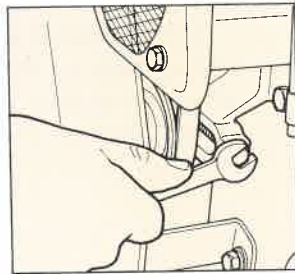

## 4. Cleaning air cleaner

### a. Cloth and Paper filter type

When the engine is operated in a dusty place, clean the element every 50 hours or earlier to keep the inside of the cleaner clean at all times. To clean the element, blow air from inside the element or rinse the element in a neutral detergent solution. Dry it completely before installing it in the original position.

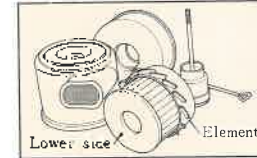
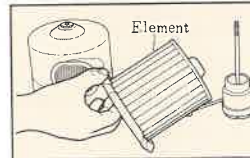

### b. Oil bath type

Clean the interior of the air cleaner and put in fresh oil up to the prescribed level.

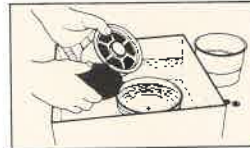

## 5. Cleaning fuel filter

Clean the fuel filter in clean gas oil.

The element should be rinsed in clean gas oil. Replace the element if it is defective. If the element has been damaged, dirt will enter the injection pump and nozzle, resulting short engine life.

## Inspection at Every 300 Hours of Operation

### 1. Replacing air cleaner element (Cloth filter type)

Replace the air cleaner element with a new one.

### 2. Cleaning fuel tank

Remove the fuel tank and clean it with a clean light oil.

### 3. Checking valve clearance (Call your nearest Mitsubishi dealer.)

Valve clearance should be checked at the top dead center on the compression stroke by turning the flywheel in the turning direction (until the TDC mark on the outer periphery of the flywheel and the indicator coincide). On the NM55H,65 the arrow mark on the side of the fuel tank is the indicator. On the NM75 and above, align the TDC mark with the mark on the crankcase or indicator. On the other engine with a flywheel cover, the center of the inspection window of the cover is the indicator.

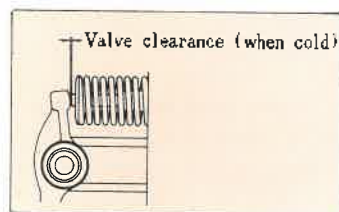

| Engine Model | Valve Clearance |
|--------------|-----------------|
| NM 55        | 0.30mm          |
| NM 65        |                 |
| NM 75        | 0.25mm          |
| NM 90        | 0.35mm          |
| NM 110       |                 |
| NM 130       |                 |
| NM 155       |                 |
| NM 180       |                 |

### 4. Checking nozzle (Call your nearest Mitsubishi dealer.)

Adjust the injection pressure of the nozzle to 120 to 130kg/cm<sup>2</sup>.

### 5. Miscellaneous

The injection pump is to the engine what the central nerve is to man. Inadequate adjustment is very dangerous to the engine. If the injection pump is malfunctioning, be sure to call your nearest Mitsubishi dealer for adjustment or repair.

## Inspection at Every 500 Hours Operation

### I. Replacing fuel filter (cartridge type)

A cartridge type fuel filter should be replaced every 500 hours or earlier. Disconnect the connection pipe to remove the filter.

## Inspection at Every 600 Hours Operation

### Replacing air cleaner element (Paper filter type : Cyclone type)

Replace the air cleaner element with a new one.

## Instructions for Dyna-starter Equipped Engine

### ① Starting Operation and Stopping

As for steps to take before starting, refer to the foregoing section in the manual. Start, run and stop the dyna-starter equipped engine by the following procedures.

#### I. Starting

- a. Open the fuel cock to send the fuel to the injection pump through the fuel filter.
- b. Before starting, turn the engine at no load to distribute oil throughout the engine. First set the battery switch to ON. While holding down the decompression lever, turn the key switch to the position "2" (START) (or depress the START button switch). This will operate the starter and will crank the engine at no load. An engine removed from service for a long period should be cranked at no load for approx. 10 to 20 seconds. An engine used every day should be cranked for approx. 5 seconds.

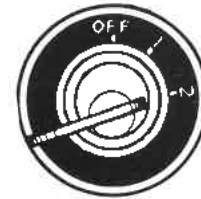

START

- c. Set the speed control lever to the START position.
- d. Hold down the decompression lever. Set the key switch to the position "2" (or depress the start button switch) and the engine will begin to rotate. After the flywheel has gained enough inertia (approx. 3 to 5 seconds after the switch has been placed in closed position), release the decompression lever and keep the engine rotating until it starts up. After the engine has started up, release the key switch (or start button switch). When the key switch is released, the key will automatically return to the position "1". Leave it at that position during operation. If the engine does not start up after 10 to 20 seconds of cranking with the decompression lever released, keep the engine at

## Instructions for Dyna-starter Equipped Engine

rest for approx. 30 seconds and then repeat the starting procedure. If the starter does not operate because of a rundown battery, start the engine with the cranking handle. (Check to discover what has caused the battery to run down.)



ON

Note : As for the cold starting procedures, refer to Page 13, 14 of this manual.

### 2. Operation

After the engine has started up, allow approx. five minutes for warmup operation before adjusting the engine to a desired speed and placing load.

### 3. Stopping

- Set the speed control lever to the STOP position to stop the engine. Never use the decompression lever to stop the engine.
- After the engine has stopped, set the key switch to "OFF" and then turn off the battery switch. On an engine with a starting button switch, do not forget to turn off the battery switch. With the battery switch in the ON position, current will flow to the charge lamp and the battery will run down.



「OFF」

## ② Periodic Inspection

### I. Daily inspection

- a. Note that the charge lamp may burn out. Before starting the engine, check to see if the charge lamp lights when the key switch is placed at the position "I." If the charge lamp does not light, it means that the lamp is defective or loosely connected or that the battery has run down.
- b. Check to see that the lamp is OFF during operation. If the lamp is ON, the battery is not on charge. Call your nearest Mitsubishi dealer inspection.

### 2. Inspection at every 100 hours

- a. Adjust the tension of the V belt of the dyna-starter. The V belt must deflect 10 to 12mm when pressed down with the thumb at a point halfway between the flywheel and starter (shown at left). Move the starter support plate to adjust the tension.

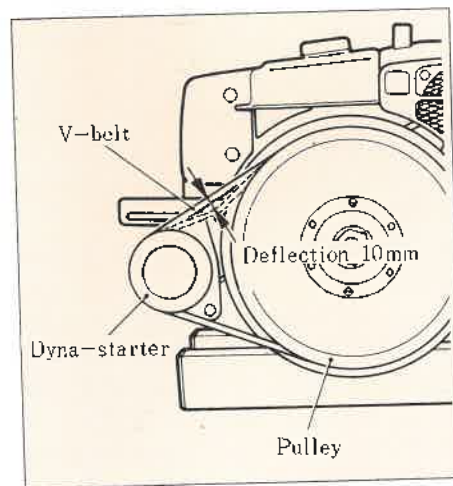

- b. Check the battery fluid level. If low, add up to the upper level. Make sure that distilled water is used for addition.



# Instructions for Dyna-starter Equipped Engine

## ③ Principal parts of electrical equipment

### I. Specifications

|                                |         |                                   |
|--------------------------------|---------|-----------------------------------|
| Dyna-starter                   | Starter | 12V, 0.7kW (NM55~110)             |
|                                |         | 12V, 1.2kW (NM130~180)            |
|                                | Dynamo  | 12V, 100W                         |
| Solenoid switch                |         | 12V                               |
| Regulator(relay)               |         | 12V, 120W                         |
| Battery(optional)              |         | 12V, 70AH (20-hour rate capacity) |
| Battery switch (optional)      |         | 24V, 600A                         |
| Key switch (Pushbutton switch) |         | 24V, 5A or more                   |
| Charge lamp                    |         | 12V, 1.5 to 3W                    |

Note : A battery switch and key switch rated for 12V may also be used.

## 2. Wiring

Make connections as shown below.

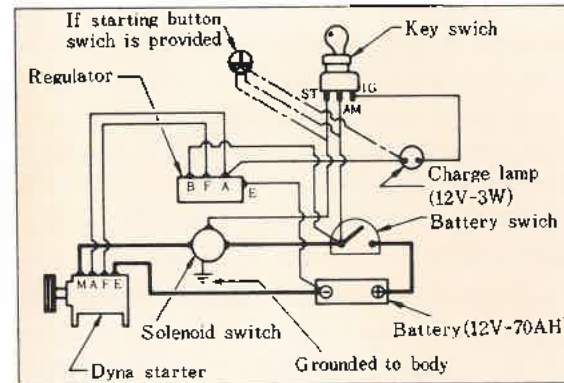

- Cross sectional area of conductor 30mm<sup>2</sup> or more.
- Cross sectional area of conductor 5mm<sup>2</sup> or more. (If conductor is less than 3m long, cross sectional area of 2mm<sup>2</sup> is acceptable.)
- - - Circuit for engine with starting button switch.

### ⊙ Wiring precautions

When wiring is laid, make sure that the following precautions are strictly observed.

1. Be sure to use cords of prescribed thicknesses.
2. Make sure that the terminals are securely brazed and crimped.
3. The electrical parts must not be exposed to rain. Arrange them in such a way as to prevent rain and muddy water. The regulator (relay) should be installed in level position.
4. The dyna-starter is grounded to the body. Ground the dyna-starter mounting bolts to the (—) terminal of the battery.
5. The solenoid switch is also grounded to the body. When that switch is installed on a non-metallic area, make sure that its mounting bolts are grounded to another metallic portion or the (—) terminal of the battery.
6. The grounding wire of the regulator should be grounded to the (—) terminal of the battery whenever possible. If it is grounded to other metallic portions, the set voltage might be changed and charge might start at a different speed.
7. Make sure that all cords are tight and secure at the terminals.
8. After the wiring has been laid, turn on the battery switch and turn the key switch to the position "I" to check to see that the charge lamp lights.
9. Keep the battery switch in OFF position except when the engine is operated. On an engine with a starting button switch in particular, make certain that the battery switch is turned off when the engine is at rest. With the switch in ON position, current will continue to flow through the charge lamp and the battery will run down.

Use a good quality of engine oil for Mitsubishi "Katsura" diesel engine especially in case when using it coupling with a power tiller under heavy loading.

The "Katsura" diesel engine, which you have bought this time, is an engine of high performance which we, Mitsubishi, are proud of to the world. In order to put the performance of this engine into full play whenever you use the engine, it is positively recommendable to use a good quality of diesel engine oil as well as good fuel.

## ⊙ Engine Oil

For engine lubrication, use diesel engine oil. The diesel engine oils are available in four types, i.e., CA, CB, CC and CD in order of higher grades. Use of CB or higher grades is recommended.

## ⊙ Selection of Viscosity

Use oil having a viscosity best suited to local atmospheric temperature. We recommend all-season oil SAE 10W-30 that maintains its viscosity despite a temperature change to minimize the viscosity problem.

The following oils are suitable for use at different atmospheric temperatures:

| Atmospheric temperature    | Viscosity        |
|----------------------------|------------------|
| Above 30°C (68°F)          | SAE 30 or 10W-30 |
| 5°C to 20°C (41°F to 68°F) | SAE 20 or 10W-30 |
| Below 5°C (41°F)           | SAE 10W-30       |

# Difference in Engine Model (Example Model NM155)

## Condenser Type

NM155  
(For General Power)

NM155E  
(With Dync-starter)

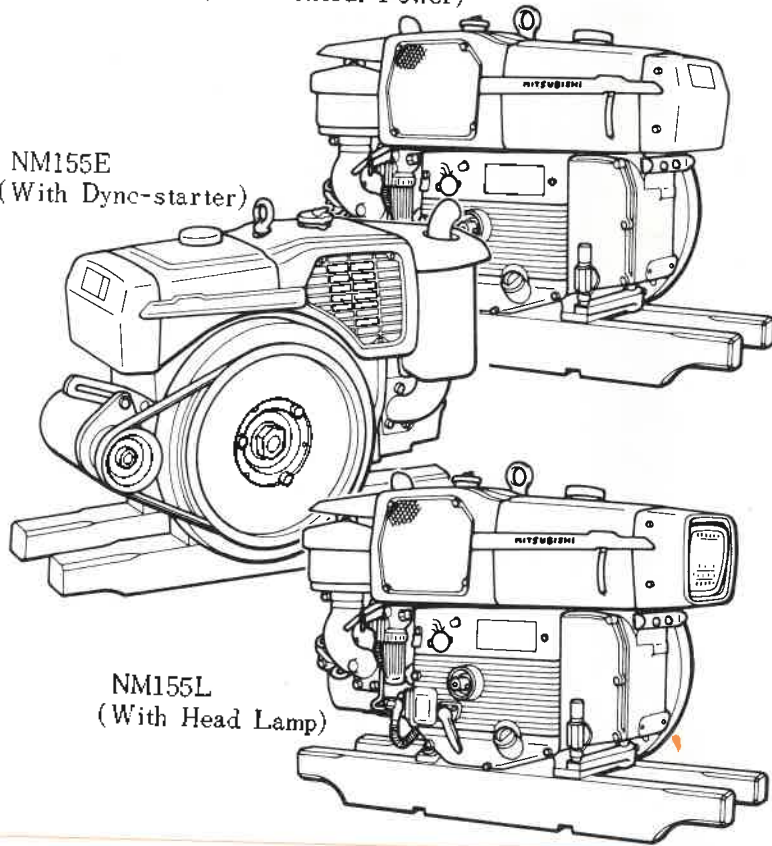

NM155L  
(With Head Lamp)

## Hopper Type

NM155H  
(For General Power)

