



# OPERATOR'S MANUAL

# ECHO TRIMMER/ BRUSHCUTTER SRM-250E



898 561-2723 0

## CAUTION

Read Rules for Safe Operation  
and Instructions Carefully

## INTRODUCTION

The ECHO Trimmer/Brushcutter, model SRM-250E, is a lightweight, high performance and gasoline powered rotary trimmer which is designed for brushcutting, weed control and grass trimming in areas which are difficult to control by any other means. The trimmer is equipped with a safety shoulder harness, and the excellent balance characteristics plus the available power, ensures comfortable operation.

A heavy duty nylon cord trimmer head is supplied as standard equipment, and special metal blades for heavy weed and brush clearing are available as optional accessories.

This manual provides the information necessary for assembly, adjustment, operation and maintenance of your unit. A spare parts list is also provided.

### SAFETY INSTRUCTIONS

1. Do Not operate the unit when you are fatigued.
2. Do Not operate if other people or animals are in the work area.
3. Do Not operate the unit without the shield correctly in position.
4. Do Not operate in a confined area. Carbon monoxide exhaust gas is highly poisonous.
5. Do Not operate the unit while you are smoking.
6. Always wear eye protection goggles when operating the unit.
7. Always hold the unit firmly with both hands and with fingers and thumbs encircling the handles.
8. Always obey local ordinances regulating the use of internal combustion engines in your area.
9. Always use the cutting attachments as approved and supplied by ECHO Inc. for your unit.
10. Always remain alert when operating the unit to avoid possible injury to yourself and other people.
11. Always wear the shoulder harness when operating the unit.

### WARNING-DANGER

1. Do Not smoke while handling gasoline.
2. Do Not refuel a hot engine. Wait until it cools.
3. Do Not overfill the tank. Spilled fuel must be wiped up.
4. Always stop the engine when refueling.
5. Always remove the fuel cap slowly in order to relieve any pressure building up in the tank.
6. Always restart the engine at least 10 feet away from the refueling point.
7. Always store gasoline in an approved container.

## ATTENTION

For your protection when operating this unit, comply with all Safety Rules as listed in the Operator's Manual. (Replacement manuals are available from your Echo dealer.)

1. Do not operate unless the debris shield and safety harness are in good condition and properly installed.
2. Do not operate if other persons or animals are in the work area.
3. Do not operate without eye protection goggles available from your Echo dealer.

## CONTENTS

	Page
Technical Data .....	2
Nomenclature of Parts .....	3
Assembling .....	3
Operation .....	4
Maintenance and Care .....	13
Trouble Shooting .....	15
Storage After Use .....	16
Parts Catalogue .....	17

### TECHNICAL DATA

Dimension	L x W x H	cm (in.)	167 x 21 x 27 (65.7 x 8.3 x 10.6)
Weight		kg (lbs)	5.2 (11.4): w/o shoulder harness and cutter head
Engine	Type Displacement Max revolution Carburetor Ignition Spark plug Starter Clutch	cc (cu.in.) rpm	Air cooled two stroke single cylinder 24.4 (1.48) 8,000 Walbro diaphragm type WA Flywheel magneto: CDI (Capacitor Discharge Ignition) system NGK-BPM-7A or CHAMPION CJ-7Y Recoil starter Automatic centrifugal clutch
Fuel	Mixing ratio  Tank capacity	liter (FL.OZ.US)	Mixture of regular gasoline and air cooled two stroke engine oil. (ECHO Oil) (32:1 Ratio or 50:1 Ratio with special oil approved by ECHO)  0.6 (20.3)
Drive shaft ass'y	Cutter Cutter (option) Cutter (option) Gear housing Lubrication Drive shaft Shield		Nylon line cutter head (Semi Auto) Eight (8) cutter blade, 8 in. Circular saw, 8 in. 60 degree spur bevel gears, ratio 1:1.25 (Counter-clockwise) Shell Delpena or good quality lithium grease High tensile solid steel, 5 bearings Plastic plate mounted on the gear housing

Technical data subject to change without notice.

(Note) U-shaped handle kit is available as optional supply.

## WARNING - DANGER

Serious injury may result from the improper use of steel blades. Comply with all Safety Instructions listed in the Operator's Manual and supplied with the blades.

1. The Echo saw tooth blade is designed to cut brush and small trees.
2. The Echo 8 tooth rotary knife blade is designed to cut heavy weeds and grass.  
**TO AVOID INJURY DUE TO KICKBACK OR BLADE FRACTURE, DO NOT USE THIS BLADE TO CUT BRUSH OR TREES.**
3. ECHO INC. will not be responsible for the failure of cutting devices which have not been tested and approved by ECHO for use with this unit.

## NOMENCLATURE OF PARTS

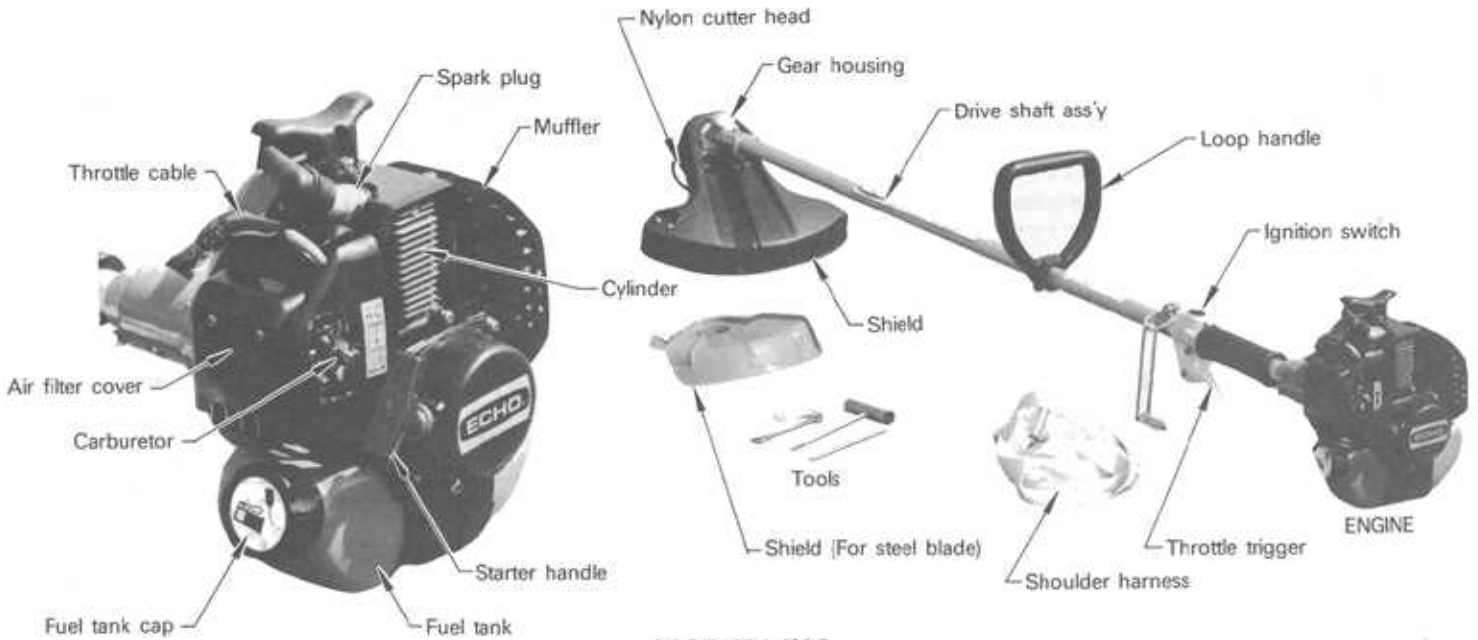

## ASSEMBLING

### DRIVE SHAFT

- Stand engine upright on a level floor.
- Fit drive shaft assembly ensuring that the drive shaft is correctly engaged.
- The line on drive shaft housing must be in contact with the engine.
- Rotate drive shaft housing until gear housing is in line with the engine.
- Tighten four 4 screw to fasten drive shaft ass'y as shown.

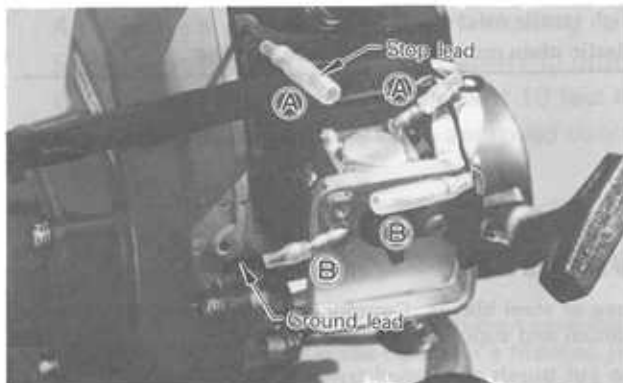
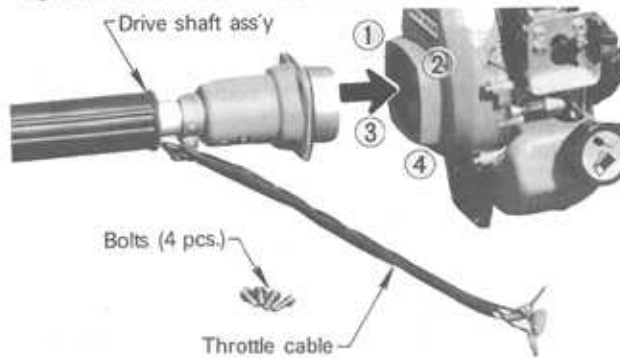

### THROTTLE CABLE

As the engine is delivered with throttle cable (engine side) separated, assemble the cable to carburetor as follows.

- Remove the cover (for air filter and carburetor)
- Remove nut (A) from throttle cable.
- Insert throttle cable through the bracket shown.
- Replace nut (A) finger tight, and attach the inner cable to swivel on throttle lever ensuring that the nipple fits into socket provided on one side of slot.
- Tighten nut (A) to secure in this position.
- Connect the both stop leads(A) and ground leads(B)
- Check that throttle operates freely and returns to idle position.
- Do not loosen nut (B) unnecessarily, as it is located properly at the factory.
- Install the cover.

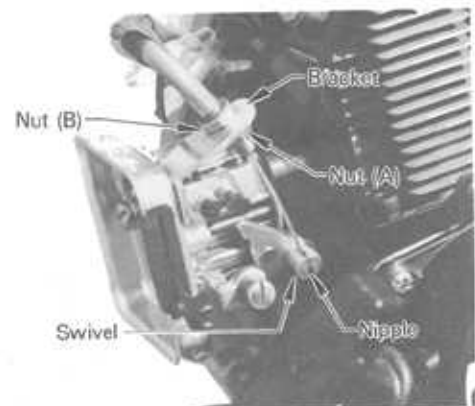

### LOOP HANDLE

- Assemble loop handle and loop handle bracket to drive shaft ass'y loosely.
- Adjust location of handle to a convenient position. Tighten the bolts securely.

### SHIELD (USE ONLY FOR NYLON LINE HEAD)

- Fit the shield the gear housing and tighten three screws
- For safe operation, never use the trimmer without shield.
- Do not use this shield for steel blades.

### NYLON LINE HEAD

- As for the NYLON LINE CUTTER HEAD follow the instructions, page 5.

### CUTTER BLADE (Optional supply)

- Follow the instructions, Page 10.

### SHOULDER STRAP

- Fit shoulder strap to hanger, and readjust length of strap to maintain the cutter head parallel to the ground.

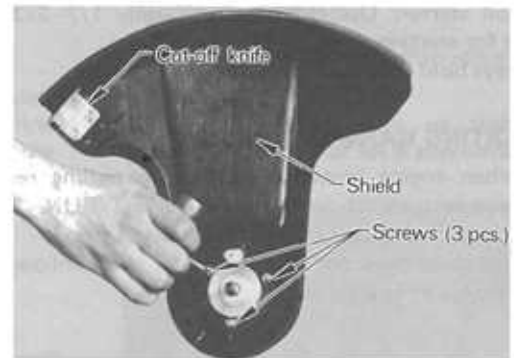
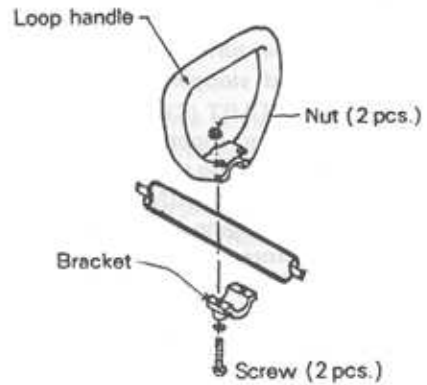

### OPERATION

- Check for loose nuts, bolts and screws before using the unit every use.

### FUEL

- Fuel used for this model is a mixture of regular grade gasoline and ECHO brand motor oil or an aircooled two stroke engine oil of a reputable brand name.
- Mixture ratio is  
Gasoline 32 parts: Oil 1 part.
  - Fuel mixture at a rate other than 32 : 1 may cause malfunction of the engine. Watch out for mixture ratio.
  - Pour 1/2 of the gasoline into a safe container, add oil and mix thoroughly.
  - Now add the remainder of gasoline and mix again.
  - Do not use motor oil other than that recommended above.
  - Do not mix directly in engine fuel tank.
- After refueling, secure the fuel tank cap and wipe all spilled fuel with a dry cloth.

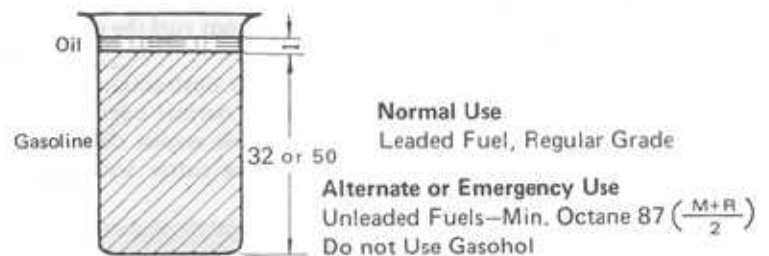

Fuel Mix Chart

32 : 1				50 : 1			
(US)		(METRIC)		(US)		(METRIC)	
GAS	OIL	GAS	OIL	GAS	OIL	GAS	OIL
Gal.	Fl.oz.	Liter	cc.	Gal.	Fl.oz.	Liter	cc.
1	4.0	4	125	1	2.6	4	80
2	8.0	8	250	2	5.1	8	160
5	20.0	20	625	5	12.8	20	400

### (NOTE)

50:1 Ratio is applicable with special oil approved by ECHO.

## STARTING COLD ENGINE

- Ignition switch is located on the throttle trigger. When starting engine, turn the switch to opposite side of "STOP" position and stopping engine turn it to "STOP" position. Turn choke lever to START (Close) position.
- Squeeze throttle trigger slightly and pull starter handle several times until first firing sound. Now, turn choke lever to RUN (Open) position, and if necessary, restart the engine again and allow to warm up for a few minutes before using.
- After idling, gradually open throttle and cutter blade will start to operate as the engine attains clutch engagement speed of 3000 ~ 3400 RPM approx.

### (NOTE)

Recoil starter: Use short pulls – only 1/2–2/3 of starter rope for starting.

Always hold the unit firmly with both hands.

## STARTING WARM ENGINE

- When engine is warm, start it by pulling recoil starter rope with switch positioned at START/RUN. (Keep choke lever in RUN (Open) position.)
- If engine does not start in a few tries, follow same procedures as to start cold engine.

## STOPPING ENGINE

- Release throttle trigger and allow to run at an idle speed.
- Turn ignition switch to "STOP" position.

## OPERATING THE TRIMMER

- Adjust handle to a convenient position for trimming as instructed on page 3.
- Allow the engine to warm up at a fast idle for a few minutes.
- Increase engine speed as necessary.
- When trimming weed or grass, swing the cutter head from right to left as you move forward.
  - Avoid striking any obstruction such as rocks, stones or tree stumps which can damage the cutter head. Do not cut into the ground.
  - To avoid damage to the engine, do not run the engine unloaded at full throttle.
- In the event that the cutter strikes an obstruction or is otherwise prevented from rotating in normal operation, the clutch will slip to prevent possible engine damage. In this case, stop the engine, free the cutter and then start the operation again.
- In an emergency, pull out quick release latch of shoulder harness to detach the unit.

### CAUTION

Do not allow either people or animals into the work area. Always wear safety goggles when cutting. Dress properly – Avoid loose clothing.

When grass or weeds have clogged the cutter head affecting normal operation, first, stop the engine and then remove it.

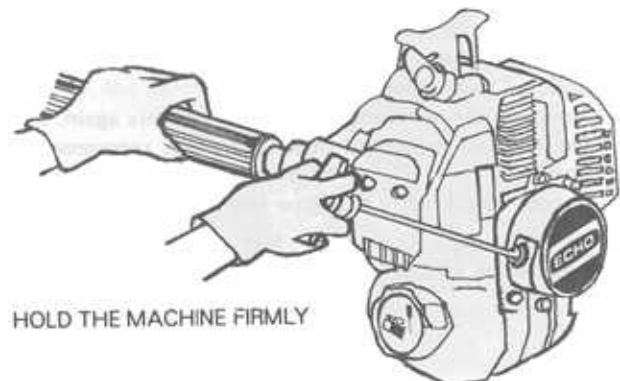
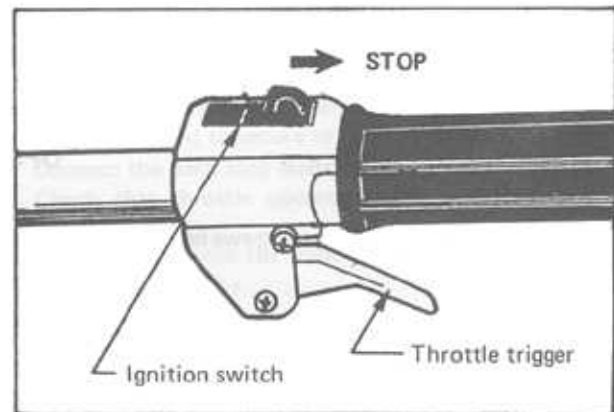
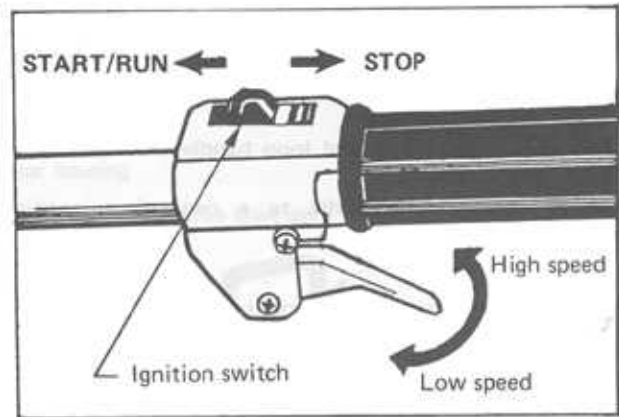

## OPERATING INSTRUCTIONS (NYLON LINE-STEEL BLADES)

Your brushcutter/trimmer, has been designed and constructed to give you years of trouble-free service and relieve you of the many back-aching tasks normally associated with grass trimming, weed control and brushcutting. Nevertheless, in common with all other power operated tools, the Owner and/or Operator has a definite responsibility to maintain the safe working condition of the unit as provided by the manufacturer, and to ensure also the safe operating procedures as prescribed by common sense and this manual. Please, therefore, read and understand the instructions as listed hereunder, and on Page 1, in order to prevent accidents and possible injury.

### NYLON LINE CUTTING HEAD (SEMI-AUTO HEAD)

#### REMOVE SPOOL

1. (Do not push spool in.) Hold drum firmly and turn spool in direction shown (Fig. 1), to take up slack, then twist with a hard snap until plastic peg is between holes (Fig. 2).
2. Pull spool out of drum.

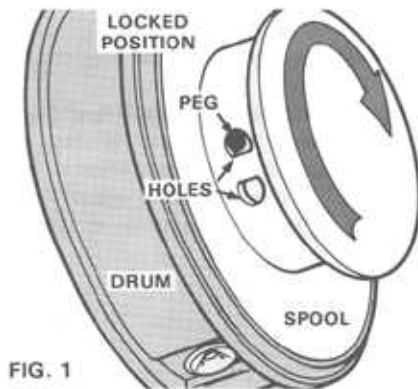

FIG. 1

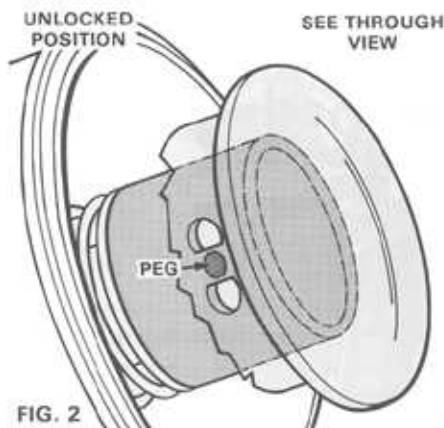

FIG. 2

#### INSTALL LINE

NOTE: Use one line, 20' long.

1. Thread end of line through hole on spool (Fig. 3), and pull through until line is the same length on both sides of hole.

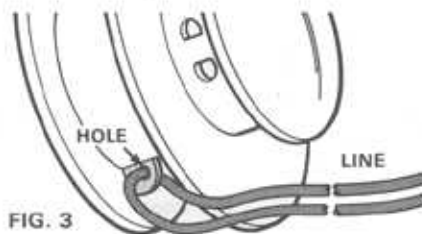

FIG. 3

2. Wind both ends of line at same time:  
A. Wind counterclockwise as shown (Fig. 4) in direction of arrow marked cc on edge of spool.

**CAUTION!** Wind tightly and evenly from side to side and do not twist line (ignore the ridge).



FIG. 4

#### INSTALL SPOOL

1. Feed ends of line out through eyelets on drum.

**CAUTION!** Keep line as tight as possible and do not let it slip under the spool into the drum.

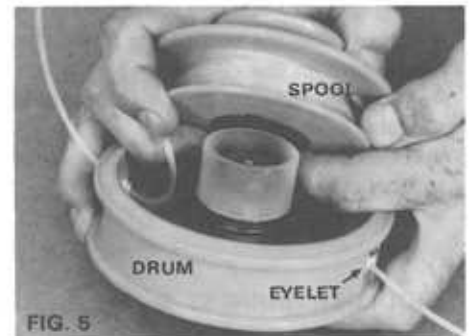

FIG. 5

2. Align pegs on drum with slots in spool and push spool into drum.

3. Hold drum firmly, twist spool sharply in direction shown (Fig. 6), until peg goes into hole with a click and locks spool to drum.

4. Cut lines to 4".

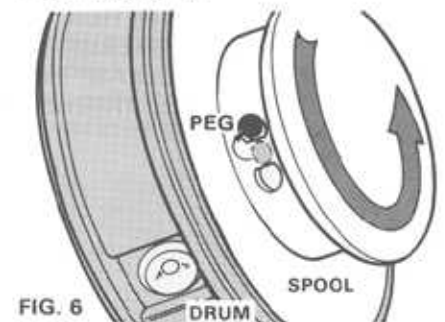
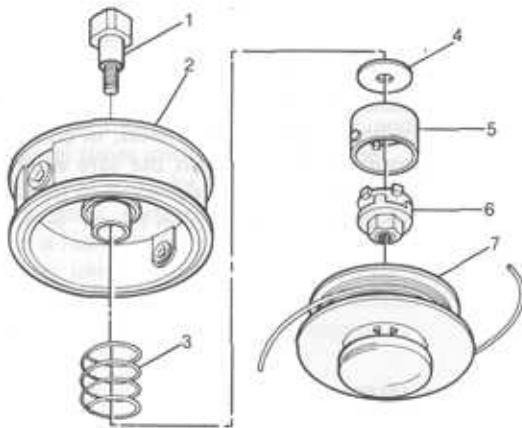

FIG. 6

Install the cutter head as shown. (Turn counter clockwise)



Cutter head



**PARTS LIST  
HEAD ASSEMBLY 21560050**

INDEX NO.	PART NO.	DESCRIPTION
1	2-15601	Bolt, shaft
2	2-15602	Drum, w/eyelets
3	2-15603	Spring
4	2-15604	Washer
5	2-15605	Outer drive
6	2-15606	Inner cam L.H.
7	2-15607	Spool (designed for use with .095 gauge line)

**CAUTION!** Use Loctite No. 262 on threads when replacing Items No. 1 and 6.

**OPERATING INSTRUCTIONS nylon line**

- Always use the end of the line for cutting. Forcing the cutter head too close to the work will result in reduced efficiency and broken line.
- Maintain the line at the recommended length of 5 to 6 inches. A longer line will reduce engine speed, a shorter line may result in engine damage.
- The trimmer head rotates counterclockwise. Always cut with the head tilted to the right to deflect debris away from the operator. (See below illustration)
- Always observe the SAFETY RULES on Page 1 when using the unit.

**SHOULDER HARNESS See Fig. 4**

- Install the harness over the left hand shoulder and adjust both waist and shoulder straps so that the quick release latch rests low on the right hand side.
- Attach the brushcutter/trimmer to the harness by means of the short strap and the quick release latch.
- Make some practice sweeps as with a scythe and readjust the harness as necessary for comfort and to maintain the cutter parallel to the ground.

**ATTENTION**  
IN CASE OF EMERGENCY, PULL THE QUICK RELEASE PIN TO DISCONNECT THE TRIMMER FROM THE HARNESS.

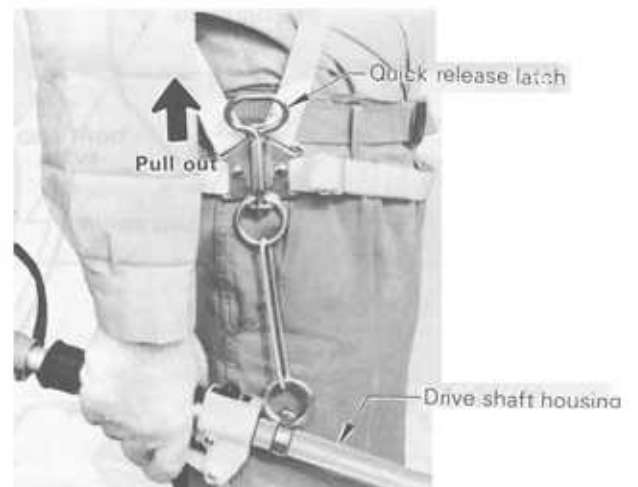
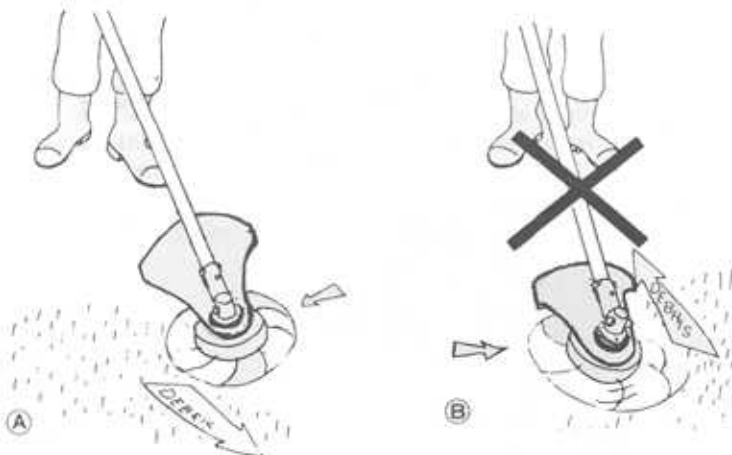

Fig. 4





## TRIMMING

The nylon line will allow you to trim along walls and fence lines. Always try to trim from right to left, walking behind the unit and parallel to the wall or fence, thus deflecting debris away from the operator. See Fig. 5.



Fig. 5

## EDGING

- The nylon line is intended only to cut grass and should not be used to cut a normal edging trench along stone or concrete driveways etc.
- Tilt the unit vertically as illustrated and use only the line tip to remove unwanted growth. See Fig. 6

### EDGING



Fig. 6

## MOWING

- The nylon line will effectively mow large areas of heavy grass and/or weeds. Use the standard 5–6 inches of line and operate at full throttle.
- When mowing cultivated areas such as lawns hold the cutter head parallel to the ground to avoid scalping. See Fig. 7

### MOWING



Fig. 7

## SCALPING

- The cleaning of weeds and grass right down to the earth can be accomplished very easily with the nylon line.
- Scalping around trees and bushes is particularly effective, but care should be exercised not to bruise the bark of young and sensitive growth.
- In flower beds, always remember that the nylon line will cut in a complete circle to avoid cutting flowers instead of weeds. See Fig. 8

### SCALPING



Fig. 8

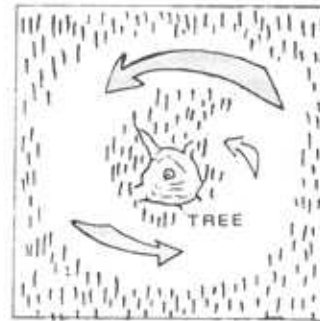

## SWEEPING

- Sweeping grass and other debris from a hard surface can be done very quickly. See Fig. 9
- Increase the length of line to about 8" per side and sweep the unit from side to side as necessary.

### SWEEPING



Fig. 9

## STEEL BLADE OPERATIONS (Model SRM-250E)

Your Echo Trimmer/Brushcutter is designed for fast, efficient weed and brush control in areas which are otherwise inaccessible to power equipment. Standard configuration includes a 'D' type handle and nylon line head for light trimming and weed clearing. Two special steel blades and a handlebar kit are available as options and recommended for use in extended heavy weed and brush clearing operations:

- |                          |          |             |                         |
|--------------------------|----------|-------------|-------------------------|
| 1. Blade: weed and grass | 8 tooth  | 8" diameter | Part No. 696 001-2033 0 |
| 2. Blade: brush          | 80 tooth | 8" diameter | Part No. 695 001-2033 0 |

### WARNING

1. Serious injury may result from the improper use of steel blades. Read and comply with all safety instructions listed in this manual.
2. The eight tooth blade is designed specially to cut weed and grass. To avoid injury due to kickback or blade fracture. **DO NOT** use this blade to cut brush or trees.
3. ECHO Inc. will not be responsible for the failure of cutting devices which have not been tested and approved by ECHO for use with this unit.

### SAFETY PRECAUTIONS

1. Always use the correct blade for the job as recommended.
2. Always convert to the handlebar configuration for extensive operations using steel blades.
3. Be careful not to hit rocks, stones, tree stumps or any foreign object which may damage the blade.
4. Do not cut into the ground to avoid dulling the blade.
5. Always stop the engine and examine the blade after striking an obstruction. Do not operate with a blade which is blunt, bent, fractured, or discolored due to overheat.
6. In the event, that the blade strikes an obstruction, or is otherwise prevented from rotating in normal operation, the centrifugal clutch will slip to prevent engine damage. In this case, stop the engine, free and examine the blade and if in good order, resume operation.
7. Should the brushcutter be operated for an extended period of high temperatures, the gear box may become very hot. If too hot to touch, allow the unit to cool down, check the lubrication as per 'Maintenance' and continue to operate if in order.
8. To avoid engine damage, do not run on full throttle without load.
9. Do not operate the brushcutter without the harness and debris shield correctly fitted.
10. Always inspect the work area and remove any foreign objects.

### SHOULDER HARNESS See Fig. 10

- Install the harness over the left hand shoulder and adjust both waist and shoulder straps so that the quick release latch rests low on the right hand side.
- Attach the brushcutter/trimmer to the harness by means of the short strap and the quick release latch.
- Make some practice sweeps as with a scythe and readjust the harness as necessary for comfort and to maintain the cutter parallel to the ground.

**ATTENTION**  
IN CASE OF EMERGENCY, PULL THE QUICK RELEASE PIN TO DISCONNECT THE TRIMMER FROM THE HARNESS.

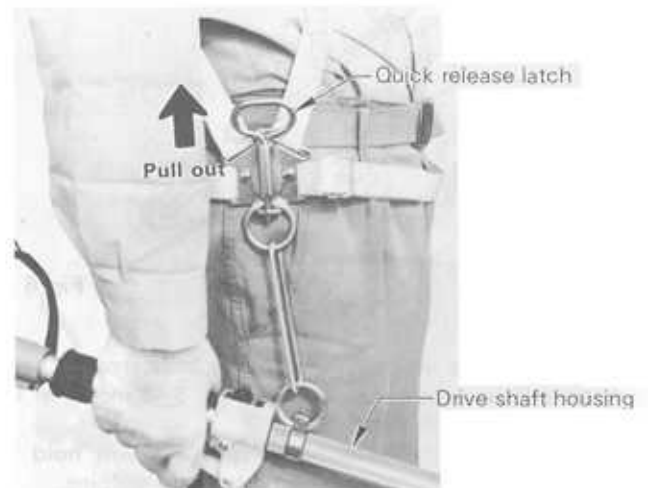
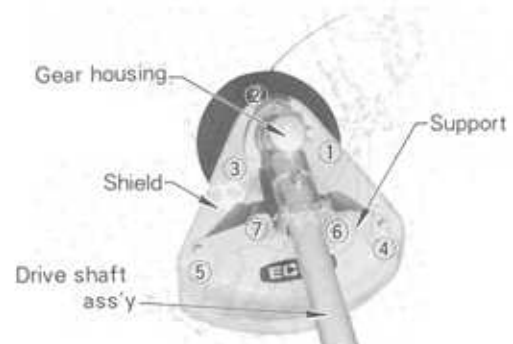

Fig. 10

### SHIELD (For steel blades)

When using a steel blade, ensure that the shield for steel blade is assembled.

- Fit the shield on the gear housing and tighten screws or nuts with washers (Seven points) as shown.



## INSTALLING THE BLADE

1. The installation of the 8 tooth weed/grass blade and the 80 tooth brush blade is exactly the same. See Fig. 11

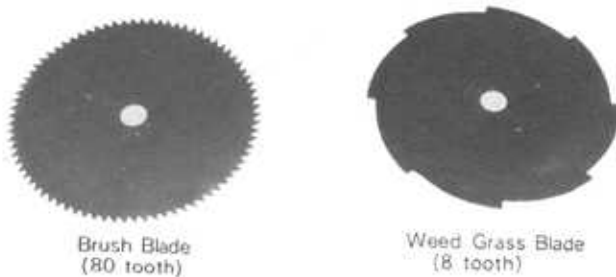

Fig. 11

2. Rotate the drive shaft until the holes in the upper adapter plate and the gear box are aligned. Insert the locking tool. See Fig. 12



Fig. 12

3. Remove the nylon line head, if fitted, by turning in a clockwise direction.
4. Install the blade ensuring that it is centered correctly on the adapter plate. See Fig. 13



Fig. 13

5. Fit the lower adapter plate and tighten the locking nut using the box wrench supplied in the tool kit. See Fig. 14

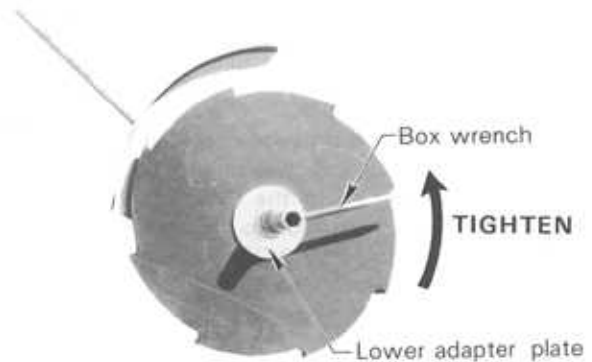

Fig. 14

6. Fit a new split cotter pin as supplied in the tool kit to secure the locking nut.

### NOTE

1. The drive shaft is fitted with left hand threads, therefore turn counterclockwise to tighten as illustrated. See Fig. 15
2. Always use a new split cotter pin to secure the locking nut. Split pin 2 x 22 mm Part No. 898502-01130.



Fig. 15

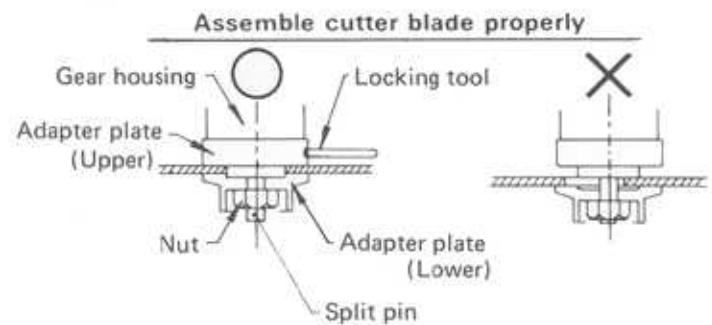

## HEAVY WEED CUTTING

1. Install the eight (8) tooth 8" blade.
2. Observing all precautions as listed in this manual, start the engine and using full throttle, swing the blade in an arc as you move forward slowly. The cutter rotates counterclockwise and the debris will be pushed backwards so the work area will always be visible. See Fig. 16

### WARNING

The 8 tooth blade is designed specially to cut grass and weeds and to simplify sharpening in the field. To avoid possible injury due to kickback or blade fracture **DO NOT** use this blade to cut brush or trees.



Fig. 16

## BRUSHCUTTING

1. Install the 80 tooth blade.
2. Proceed exactly as for weed and grass cutting.

See Fig. 17



Fig. 17

**SMALL TREES**

1. The unit will effectively cut small trees up to 3 inches in diameter using the 80 tooth 8 inch diameter new blade.
2. Before attempting to cut, ensure that the falling tree will fall away from you, and if necessary, tie a rope to the tree and have an assistant pull it in a safe direction.
3. Do not attempt to "plunge cut", i.e. using the brush-cutter like an axe. It is not necessary and may cause serious damage to the brushcutter. See Fig. 27
4. Brace your feet firmly on the ground and cut with the left hand side of the blade.

**CAUTION**

1. Always cut on full throttle.
2. Never try cutting with a blunt blade.

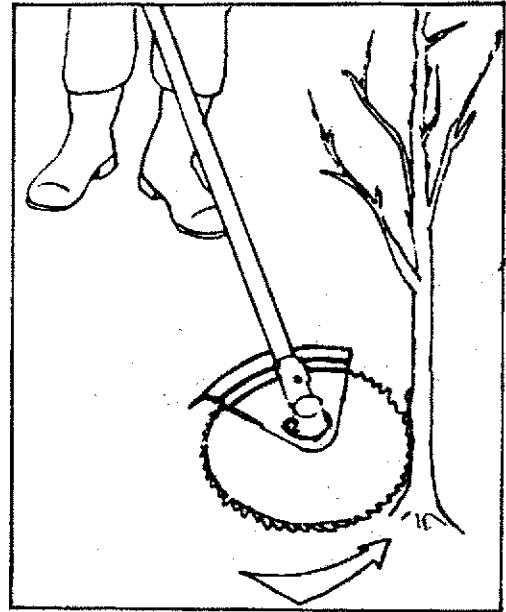
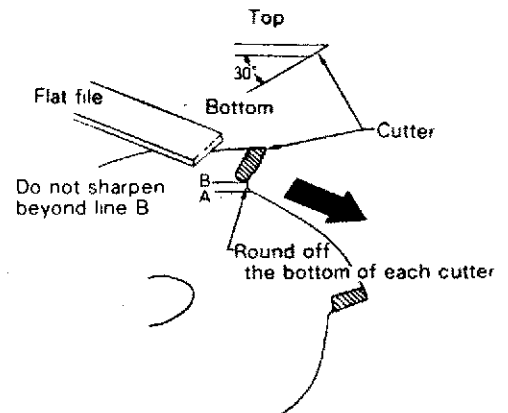

**Fig. 18**

\*\*\*\*\*

**EIGHT (8) CUTTER BLADE (Optional supply at extra cost)**

- Use only the blade designated by the manufacturer for this model.
- When crack is noticed on the blade, never use it, but replace with a new one.
- Round the teeth bottom for 1 – 2 mm radius in order to avoid the crack using a round file.
  - Rounded part is not to be sharpened.
  - Sharpen each cutter equally so as to retain the balance of the blade.
  - In sharpening the edge by use of a grinder, do not cool the cutter abruptly by immersing it in water.



## MAINTENANCE AND CARE = ALWAYS KEEP THE UNIT CLEAN =

### AIR FILTER

- Clean every day.
  - Remove air cleaner cover w/filter.
  - Brush off dust lightly or wash it in suitable cleaning fluid.
  - When you wash it in a solvent, dry it completely before putting back in place.
  - Install the cover.

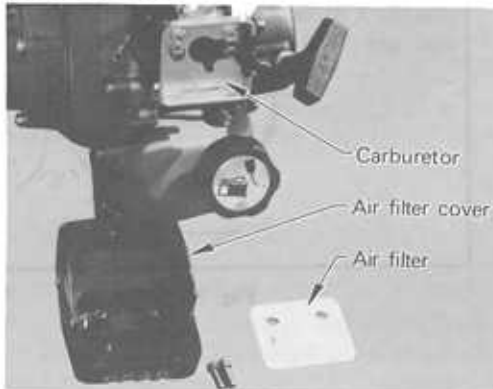

### FUEL STRAINER

- Check periodically.
  - Do not allow dust to enter into fuel tank.
  - Clogged strainer will cause difficulty in starting engine or abnormalities in engine performances.
  - Pick up fuel strainer through fuel inlet port with a piece of steel wire or the like.
  - When strainer is dirty, wash it in suitable cleaning fluid solvent.

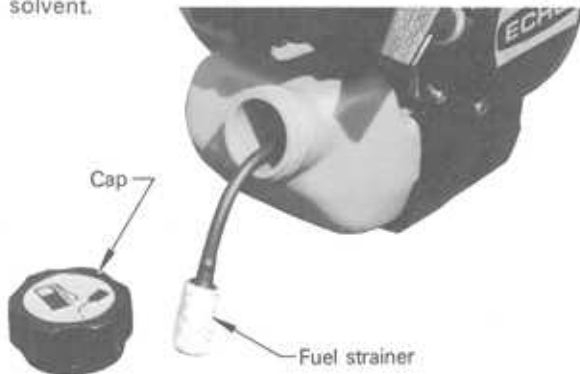

### MUFFLER AND EXHAUST PORT

- Clean as necessary.
- Carbon deposits in cylinder exhaust port and muffler will reduce engine output.
  - Muffler can be removed by taking off muffler cover.
  - Be careful not to scratch cylinder or piston when cleaning cylinder exhaust port.

### CYLINDER FINS

- Check periodically.
- Clogged fins will result in poor engine cooling.
- Remove dirt and dust from between fins to let cooling air pass easily.

### SPARK PLUG

- Check periodically.
- Standard spark gap is 0.6–0.7 mm (0.024–0.028 in.)
- Replace if either electrode is worn or if the insulator is fouled by oil or other deposits.
- TORQUE = 145 – 155 kg-cm (125 – 135 in. lb)

**CAUTION**  
Do not over torque.



### GEAR HOUSING

- Remove the bolt every 50 hours and check.
- Replenish as necessary, but do not overfill.
  - Shell delpena or good quality lithium multi grease is recommendable.

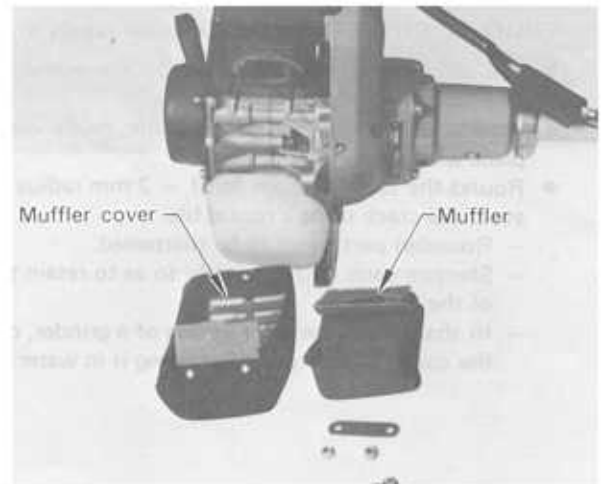
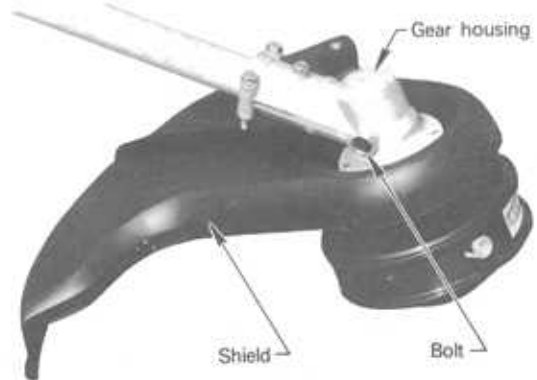

## CARBURETOR

- Carburetor is set at the factory. So normally, further adjustment is unnecessary. If readjustment is required, refer to the following instructions.

The diaphragm carburetor has three external adjustments, and to some extent, the adjustment of each will affect the other two. It will be necessary, therefore, to readjust each until satisfactory performance is achieved.

### 1. Idle speed adjusting screw.

This adjustment controls the throttle opening in the idle position.

### 2. Low (LO) speed needle screw.

The low speed needle controls the volume of fuel/oil mixture at low engine speed. It also controls the supplementary fuel required to obtain smooth progression from idling to high speed.

### 3. High (HI) speed needle screw.

The high speed needle controls the volume of fuel/oil mixture at full throttle opening.

Turn both 'HI' and 'LO' needles clockwise until fully closed.

## ADJUSTING THE CARBURETOR

### INITIAL SETTING HI AND LO NEEDLES

Turn both HI and LO needles clockwise to seat lightly in the carburetor body

#### CAUTION

The needle screws have a sharp point. To avoid carburetor damage, do not use excessive force.

Unscrew the 'LO' needle one complete turn.

Turn the idle speed adjustment screw clockwise until the throttle is slightly open.

Start the engine and run for a few minutes on high idle until the engine is warm. Allow the engine to idle, and if necessary, readjust the idle speed screw to keep the engine from stalling.

### 'LO' SPEED ADJUSTMENT

Turn the 'LO' needle clockwise slowly and note the position at which the engine speed is reduced. Now turn the 'LO' needle counterclockwise and again note the position when speed is reduced. Set the needle in the midway position. Finally, adjust the engine idling speed by turning the idle speed screw in a clockwise direction until the clutch just begins to engage. This indicates a speed of 3000–3400 RPM. Now reduce engine speed by turning the screw counterclockwise one half turn.

### 'HI' SPEED ADJUSTMENT

Engine must be at normal operating temperature.

Turn the 'HI' needle counterclockwise 1-1/4 turns.

Run the engine at full throttle and turn the 'HI' needle slowly clockwise until the engine runs smoothly without "four stroking" on no load.

Turn the needle open again (counterclockwise) 1/8 turn to obtain optimum fuel for full power under load conditions.

#### CAUTION

**DO NOT RUN THE ENGINE ON FULL THROTTLE LONGER THAN 5-6 SECONDS TO AVOID DAMAGE TO ENGINE.**

## MAGNETO

The unit is incorporated with magneto of C.D.I. (Capacitor Discharge Ignition) system, which does not require adjustment of ignition timing and the contact breaker point gap. Ensure wire connections and couplers assembling.

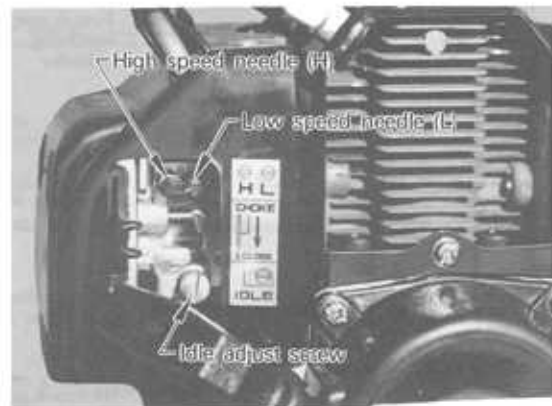
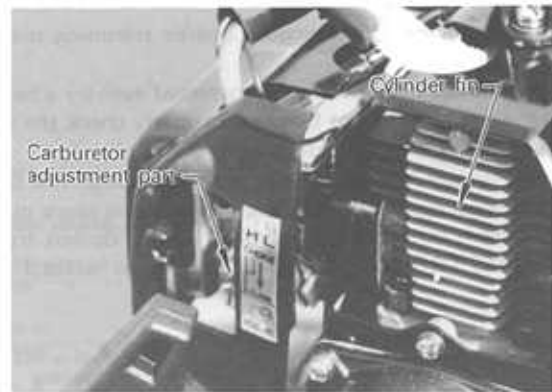

## NYLON LINE CUTTER

- Refer to instructions, page 5.

### EIGHT (8) CUTTER BLADE (Optional supply at extra cost)

- Use only the blade designated by the manufacturer for this model.
- When crack is noticed on the blade, never use it, but replace with a new one.
- Round the teeth bottom for 1 – 2 mm radius in order to avoid the crack using a round file.
  - Rounded part is not to be sharpened.
  - Sharpen each cutter equally so as to retain the balance of the blade.
  - In sharpening the edge by use of a grinder, do not cool the cutter abruptly by immersing it in water.

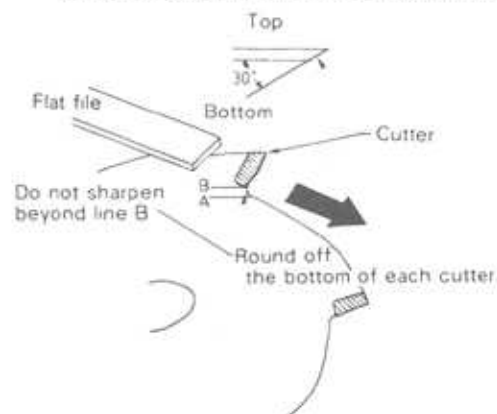

## TROUBLE SHOOTING

Poor performance of the engine and/or trimming mechanism can normally be prevented by carefully following the above instructions.

Poor performances can easily be corrected even by a beginner.

When the engine does not function properly check the following three (3) points first.

- Is engine compression adequate?
- Is fuel system in good condition and is enough fuel being supplied?
- Is electrical system in good condition and is spark plug operating normally?

When there is serious trouble with the unit, do not try to repair it yourself but have your distributor or dealer do it for you. For detailed **TROUBLE SHOOTING** refer to tables 1 and 2. Locate the problem on the following charts and repair as necessary.

**Table 1**

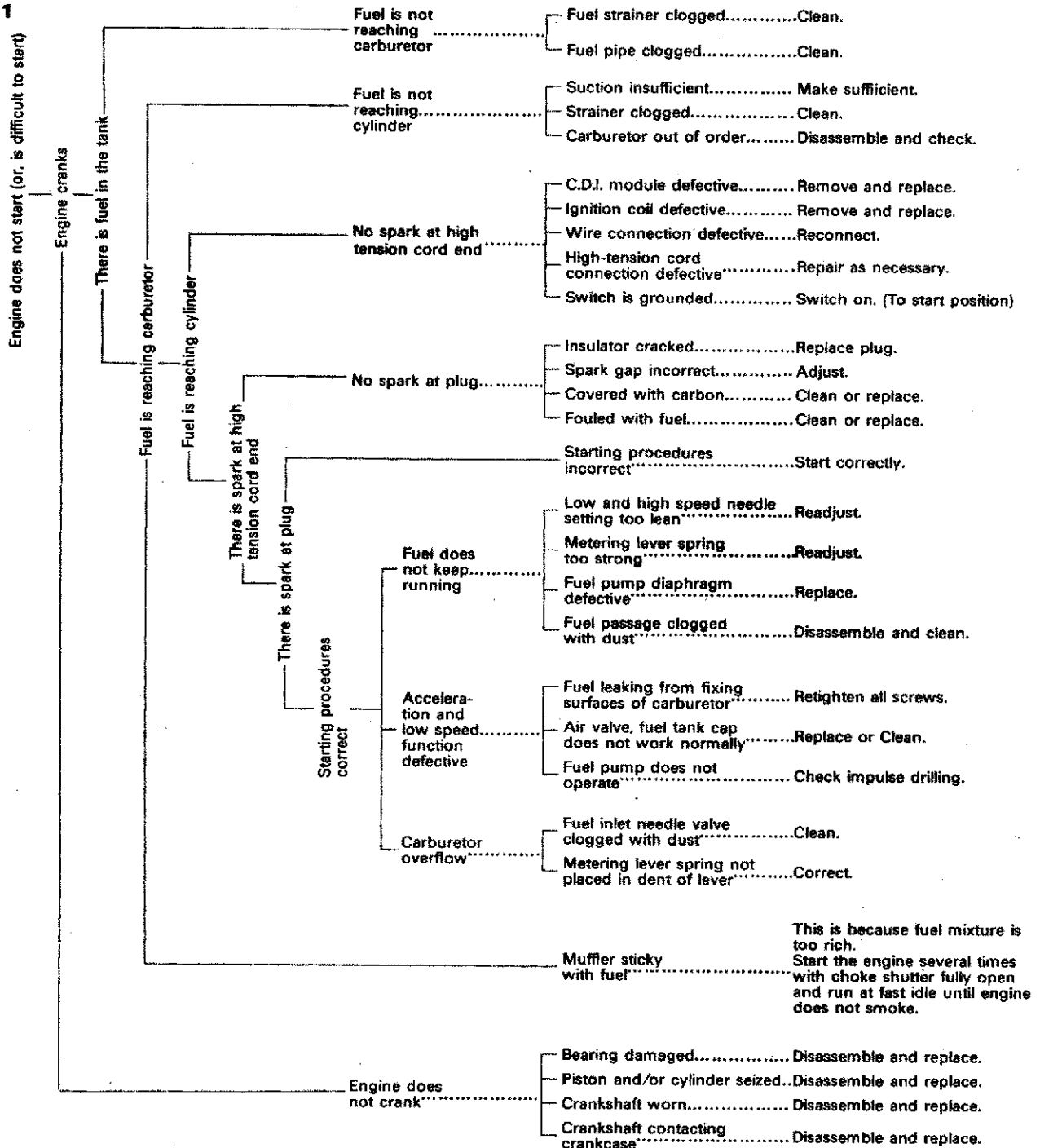



**Table 2**

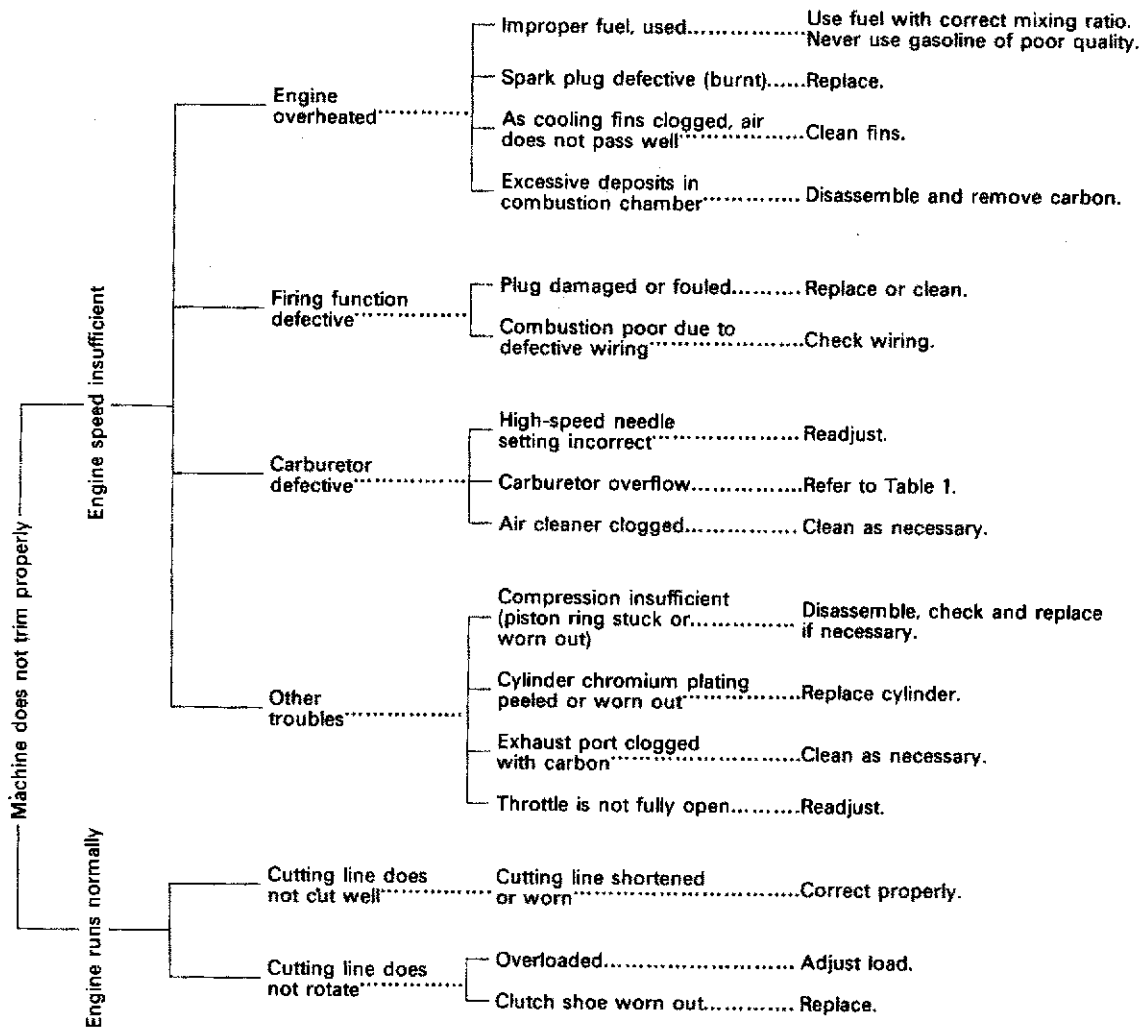

### STORAGE AFTER USE

- Inspect and adjust every part of the unit.
  - Completely clean every part, and repair, if necessary.
  - Apply thin coating of oil on metal parts to prevent rust.
  - Remove the cutter head, apply sufficient oil coating and wrap up in plastic.
- Drain fuel tank, pull starter handle slowly a few times to drain fuel from carburetor.
- Pour a small amount of clean motor oil into spark plug hole, pull starter handle and then crank the engine until TOP DEAD CENTER.
- Store in a dry area, free from dust.