

KIORITZ ECHO CHAINSAW

INSTRUCTION MANUAL

● MODEL CS-451VL

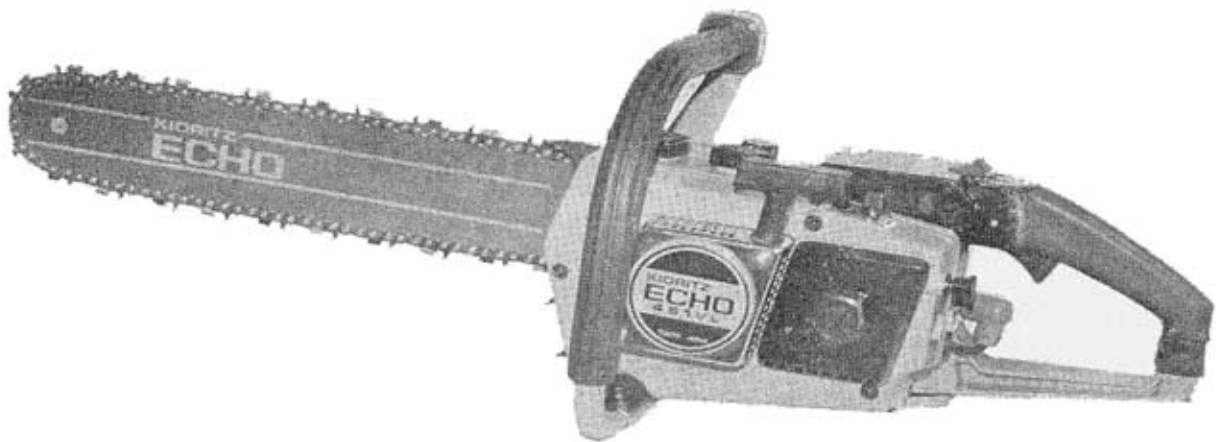

KIORITZ CORPORATION

CONTENTS

| | | |
|-----|---|----|
| 1. | Specifications | 2 |
| 2. | Designations of parts | 3 |
| 3. | How to fit the bar and chain | 4 |
| 4. | Fuel and lubricant | 6 |
| 5. | Starting the engine | 7 |
| 6. | Running and stopping the engine | 9 |
| 7. | Felling and lumbering | 10 |
| 8. | Tips for your safety | 11 |
| 9. | Setting the chain and servicing the bar | 12 |
| 10. | Engine maintenance | 16 |
| 11. | Trouble shooting | 23 |

I. SPECIFICATIONS

● Engine

| | |
|---|---|
| Type: | Air-cooled, 2-cycle, single-cylinder engine |
| Piston displacement: (bore x stroke) | 44.3 cc (2.7 cu. in) (42 mm (1.65") x 32 mm (1.26")) |
| Direction of revolution: | Counterclockwise when viewed from the magneto side |
| Magneto: | Flywheel magneto type |
| Ignition plug: | NGK BM-6A |
| Carburetor: | Tillotson diaphragm type HU-9B |
| Fuel: | Gasoline-oil (Kioritz Echo Oil) mixture (Mixing ratio: 20 : 1) |
| Cooling system: | Forced air cooling |
| Starting system: | Recoil starter |
| Lubricating system: | Manual or automatic oiler |
| Chain oil: | Kioritz Chain Oil |
| Transmitting system: | Automatic centrifugal clutch |

● Tank capacity

| | |
|------------|-----------------------|
| Fuel tank: | 0.57ℓ (1.2 U.S. pt) |
| Oil tank: | 0.25ℓ (0.528 U.S. pt) |

● Saw

| | |
|---------|---|
| Chain: | Chain pitch 3/8"; Chain gauge 0.050"; Number of drive links 59 |
| Bar: | Gauge 0.050"; Length 16" (16K50) |
| Weight: | 11.5 lb (dry) (chain and bar excluded) |

2. DESIGNATIONS OF PARTS

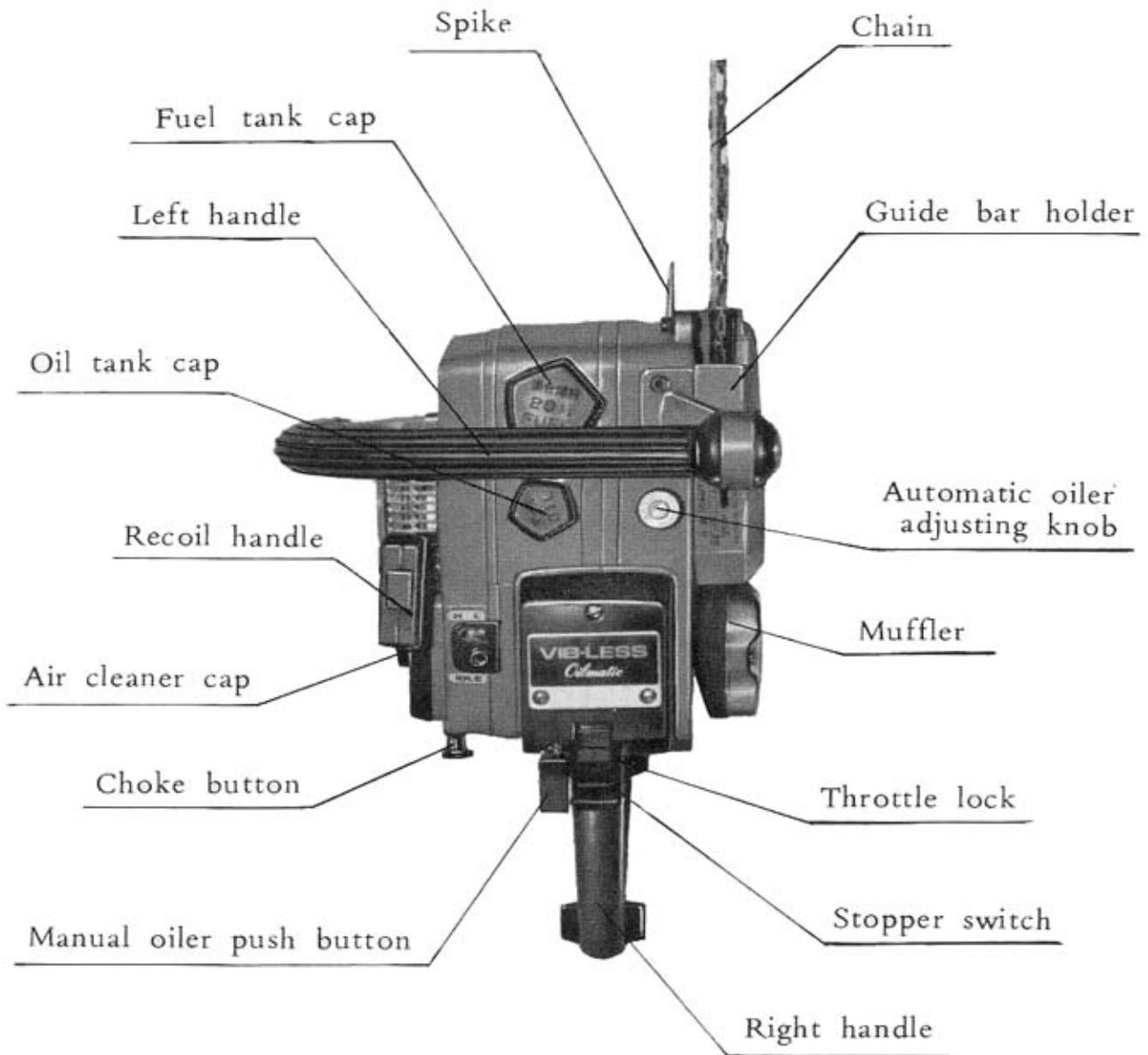

3. HOW TO FIT THE BAR AND CHAIN

- * Take off the guide bar holder, one of the guide bar side plates and a piece of wood.
- * Leave the other side plate in place.

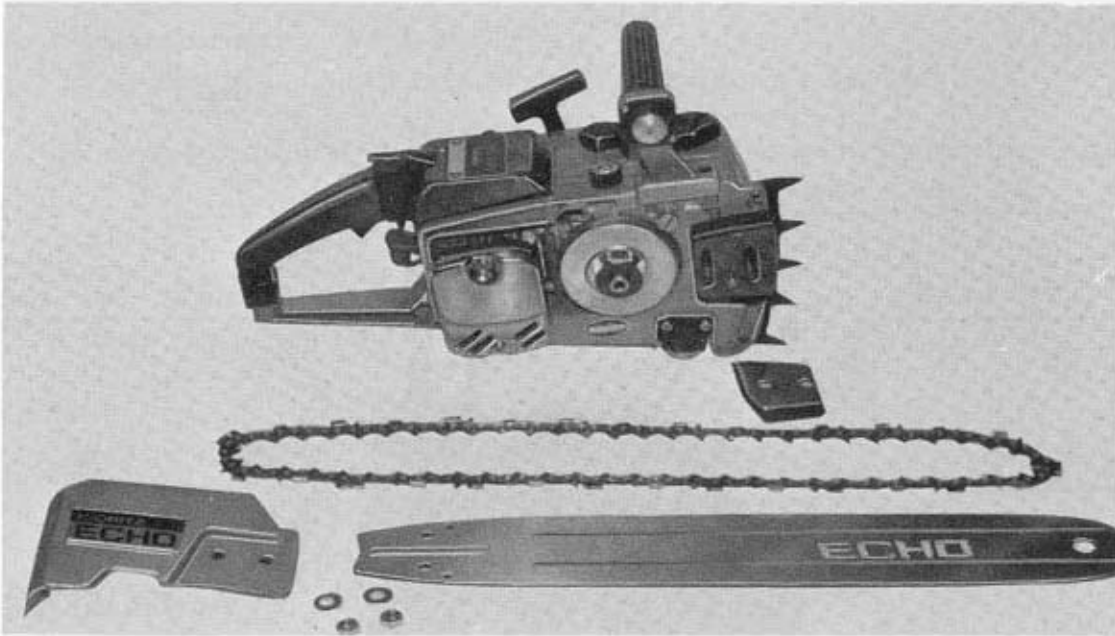

- * To set the bar, insert the chain tensioning lug into the bar hole.
- * Put one end of the chain on the sprocket first, then the other end of it on the bar end.
- * Be sure to place the chain in the right direction.
- * Next, fit the guide bar side plate, and the guide bar holder.
- * Put the washers and nuts on, and tighten the nuts lightly.

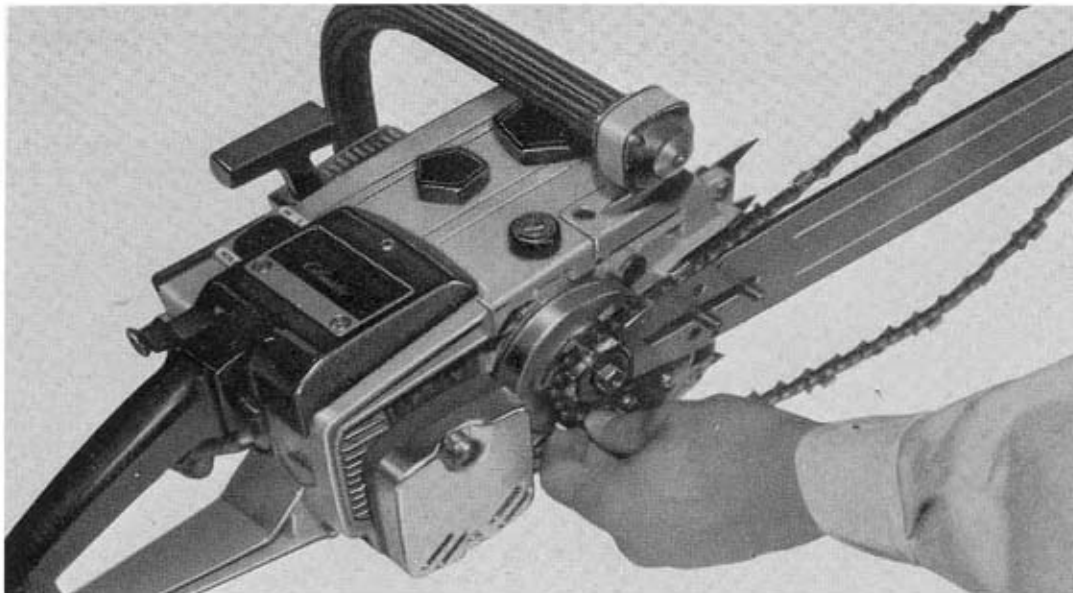

- * To tension the chain, hold up the bar end by the hand, and turn the adjusting screw clockwise.
- * To obtain a proper tension of the chain, get the chain come into contact with the bar at the lower end of latter, and turn the adjusting screw out about 1/8 turn.

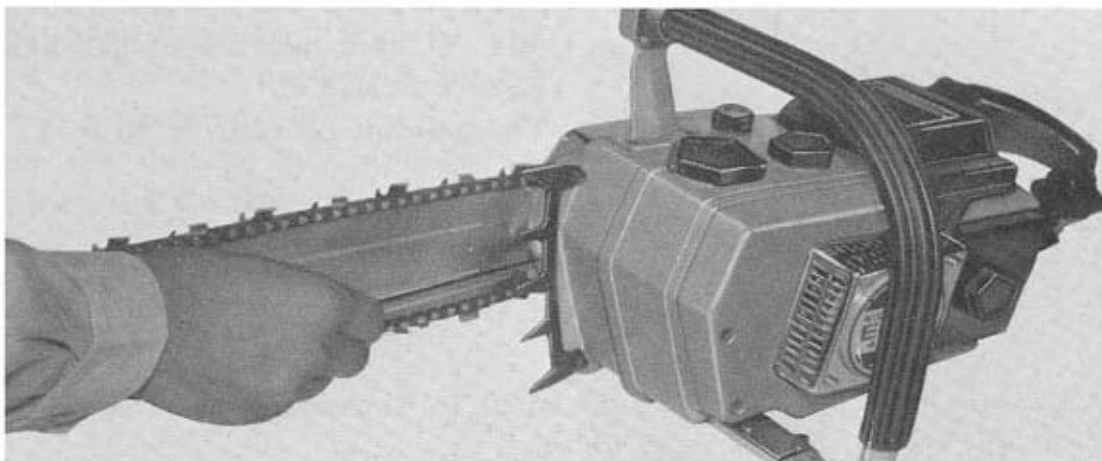

- * Finally tighten the two nuts firmly with a double-ended wrench while keeping the bar end slightly up.

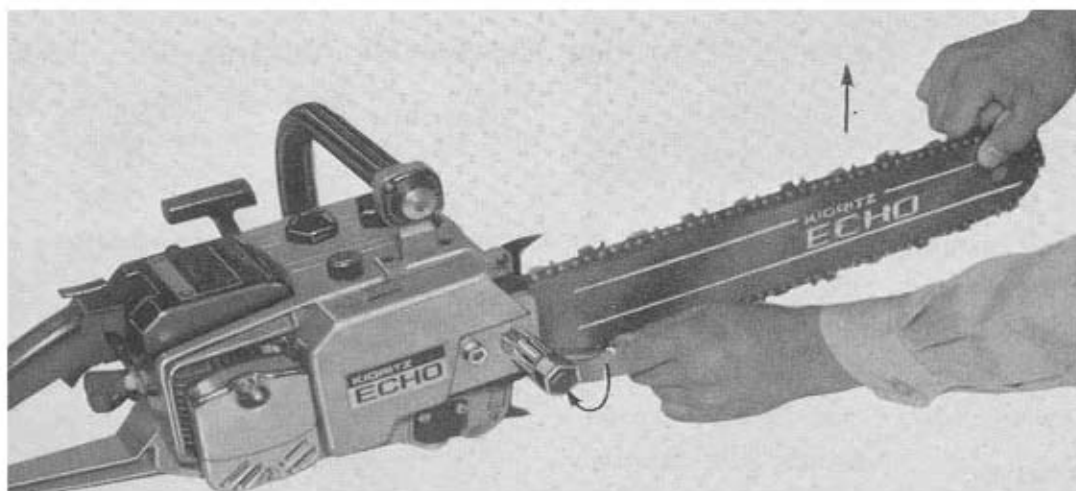

Caution:

The correct chain tension is one of the most important factors in achieving a maximum performance. It should be remembered that:

- * Too tight a chain will cause premature wear of the bar and the chain as well.
- * Too loose a chain is extremely dangerous. It will get out of place.
- * When there is no noticeable clearance between the chain and the bar at the lower end of the latter, and the chain can be slid on the bar very smoothly by the hand, this indicates that the chain tension is correct.
- * When turning the chain by the hand, be careful no to have the hand cut.

4. FUEL AND LUBRICANT

Fuel

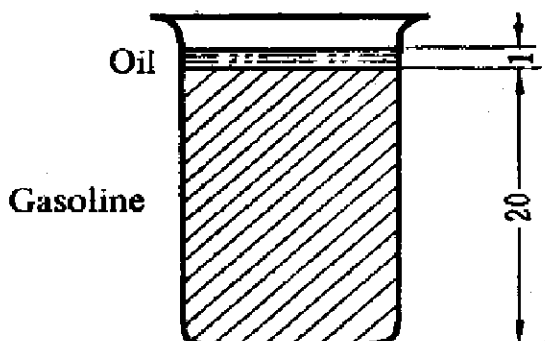

- The fuel used for operating the Echo 451 VL is a mixture of gasoline and Kioritz Echo Oil.
- The gasoline-oil ratio is 20 to 1.

Notes:

- ☆ Make sure that the mixing ratio is 20 to 1. Any other ratio will bring about engine troubles.
- ☆ If Kioritz Echo Oil is not obtainable, use motor oil for 2-cycle engines.
- ☆ Do not use any oil other than Kioritz Echo Oil or motor oil for 2-cycle engines.

Table for Preparing Gasoline-Oil Mixture

| Gasoline (ℓ) | Oil (ℓ) | ⋮ | Gasoline (ℓ) | Oil (ℓ) |
|--------------|---------|---|--------------|---------|
| 1.0 | 0.05 | ⋮ | 6.0 | 0.30 |
| 2.0 | 0.10 | ⋮ | 7.0 | 0.35 |
| 3.0 | 0.15 | ⋮ | 8.0 | 0.40 |
| 4.0 | 0.20 | ⋮ | 9.0 | 0.45 |
| 5.0 | 0.25 | ⋮ | 10.0 | 0.50 |

Lubricant

Appropriate lubrication to the chain in operation will reduce to the minimum the friction between the chain and bar, and will assure a longer service life. For lubrication, apply Kioritz chain oil.

Notes:

- ☆ Do not use waste or reclaimed oil which will cause various troubles.
- ☆ If Kioritz chain oil is unavailable at your nearby shop, use motor oil having the following grade:
 - SAE # 30 in summer
 - SAE # 10 in winter (or when cutting resinous trees)

5. STARTING THE ENGINE

When the engine is cool

- * Fill the tanks with mixed fuel and lubricating oil, respectively.
- * Push the stop switch in the direction of the arrow, as shown in the right-hand figure.
- * Pull the choke button in the arrow's direction.
- * Life the throttle lock nob up to lock the throttle trigger.



- * Before pulling the recoil starter rope, be sure to hold the chainsaw firmly on the ground by the foot.



- * Pull the rope 5 or 6 times, and the engine will emit the first firing sound. Then push the choke button back to the original position. Next, pull the rope, and the engine will start.
- * Be careful of the chain which will be put in operation after the engine has started. After the engine has started running, pull the throttle a little and release it so that it is unlocked
- * and the engine runs in low speed.

When the engine is warm

- * To start the engine, lock the throttle and pull the starter rope. If the engine will not start, pull the rope in the same procedures as in the case where the engine is cool.

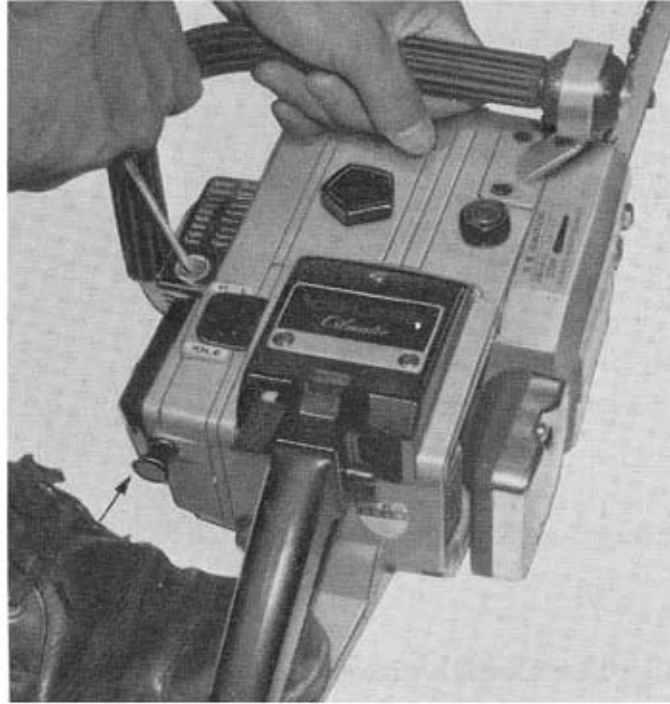

Notes:

- ☆ When the engine is warm, it can be started by pushing the stop switch and pulling the rope, without using the throttle and the choke.
- ☆ When trying to start the engine with the choke pulled, never fail to put the choke in the original position as soon as the first firing sound is heard.

6. RUNNING AND STOPPING THE ENGINE

- * After the engine has started, keep it running at a low speed for 5 to 6 minutes.
- * After idling the engine, pull the throttle gradually to run it fast.
- * The chain starts turning when the engine speed reaches about 3,000 r.p.m.
- * When the chain has started turning, press the manual oiler push button two or three times.

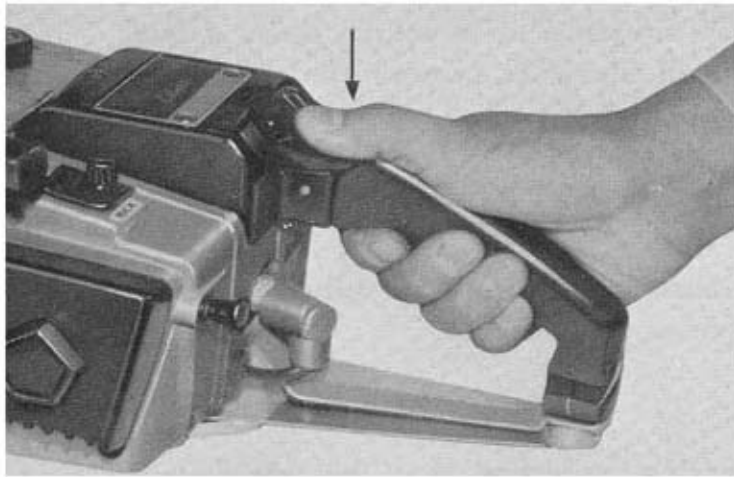

- * When idling the engine, adjust the engine speed by turning a knob located on the air cleaner. Turning it clockwise makes the engine run fast, and turning it counterclockwise makes it run slow.



- * To stop the engine, release the throttle and pull the switch to "OFF" side.

7. FELLING AND LUMBERING

- * It is essential to familiarize yourself with your chainsaw before starting actual cutting operations.
- * To this end, try cutting a felled tree several times.
- * To cut a tree, open the throttle fully and place the spike against the tree, and the chain saw will do the rest. It is not required to firmly press the chainsaw against the tree.

Felling

- * Decide on the direction of knocking down a tree.
- * Then remove all obstacles around the tree so that you can operate the chainsaw with ease and safety.
- * Further, for the safety sake, find a shelter near the tree.
- * Make a cut on the tree on the side to which the tree is to be brought down.
- * Then make another cut on the opposite side at a level a little higher than the previously made one.

Lumbering

Before lumbering, ascertain that the tree felled is firmly placed on the ground.

Keep the tree off the ground by using a support lest the chain or bar is caught in the cut.

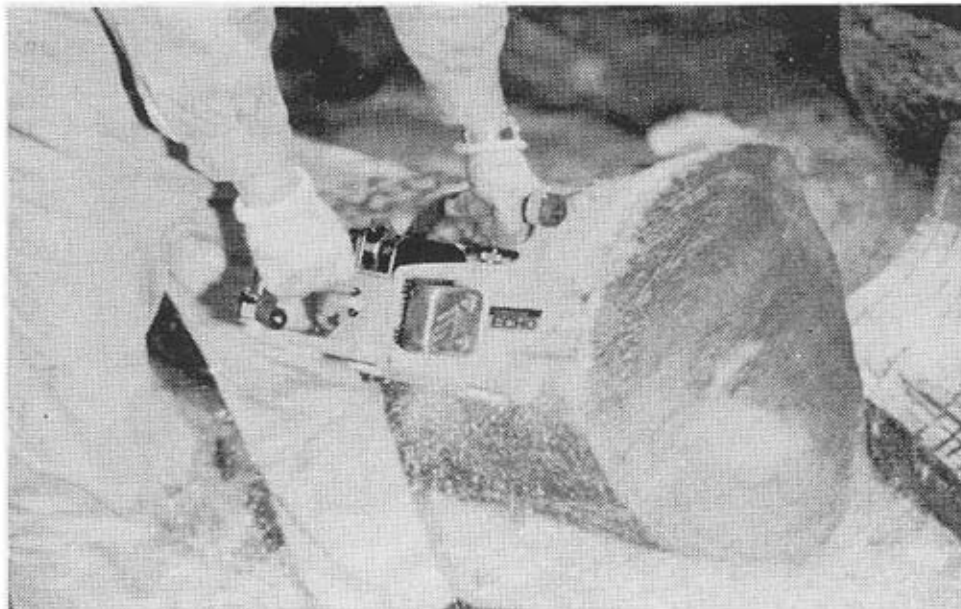

8. TIPS FOR YOUR SAFETY

Be sure to observe the following because felling and lumbering operations often attend extreme dangers:

1. Start the engine unaided, keeping any person off.
2. Do not let anybody come near the chainsaw operator.
3. When two operators or more are to work at the same time, there should be left a sufficient space between each other.
4. If an operator is to move to another place, be sure to stop the engine first.
5. When required to adjust the chain tension or to set the chain, stop the engine.
6. Hold the chainsaw by both hands when cutting a tree.
7. Replenish fuel at a place where there is no fire.
8. Do not try to start the engine at the place where fuel has been supplied.

9. SETTING THE CHAIN AND SERVICING THE BAR

Designations of parts

- * Chain parts are named as shown in the figure below.
- * The chain pitch for the Echo 451 VL is 9.525 mm (3/8").
- * Do not use a chain with a pitch other than the above-mentioned.

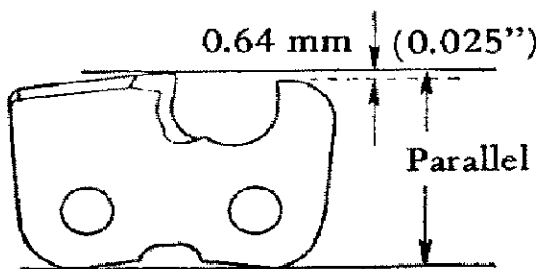
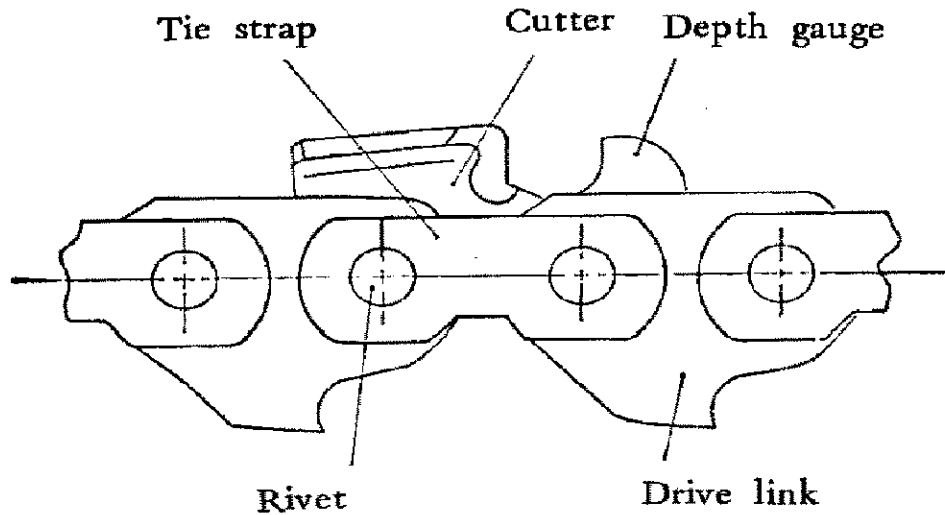

- * The depth gages are intended for limiting the thrust at the time of cutting.
- * The right and left cutters must be kept equally sharp.

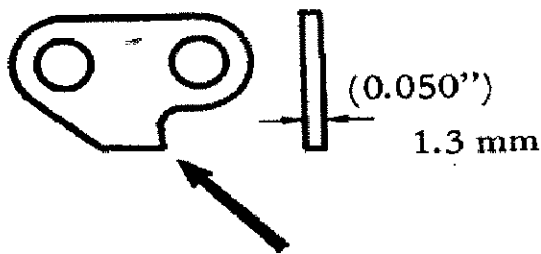

- * The drive links serve to eliminate sawdust from the bar groove. Therefore, the lower end of each link should be kept sharp.

Setting the chain

Care must be exercised in maintaining the chain, as follows:

1. The cutters must be kept sharp.
2. The right and left cutters should be regular in size.

If they are blunt or irregular in size, the cutting efficiency will drop, and the chain vibrations will increase, bringing the machine to a premature damage.

Correct setting procedures

- * The chain may be set by the use of a 5.5 mm (7/32") round file or a flat file.
- * If the cutters have become smaller after being set many times, a 5 mm (3/16") round file may be used instead of a 5.5 mm (7/32") one.
 - * Fix the file on the file holder.
 - * Put the file holder on a cutter and smooth the cutter only when you push the file.
 - * Do not smooth the cutter when you pull the file.

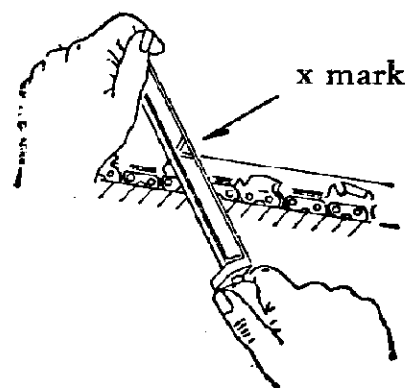
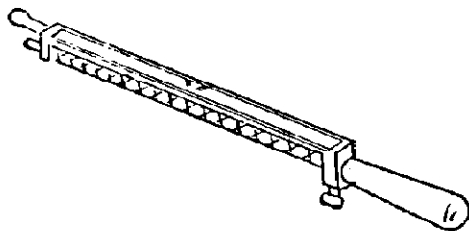

(Correct direction and position of file)

1. Upper edge setting angle (35°)

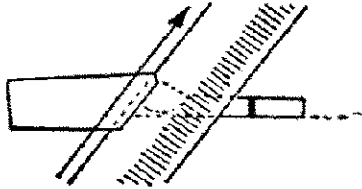

The angle of 35° is the standard.

Length of edge

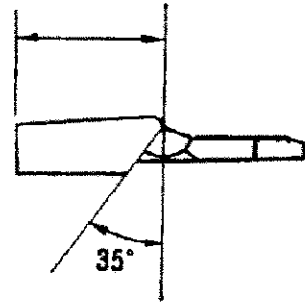

2. Lateral edge setting angle (85°)

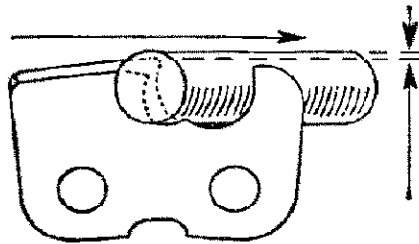

Use the file, maintaining a space of one tenth the file diameter, as illustrated.

Chain pitch: $3/8''$

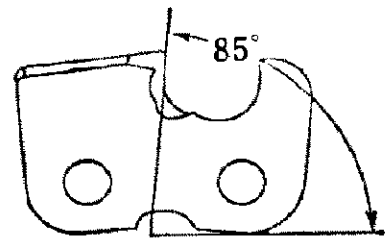

3. Upper edge end angle (60°)

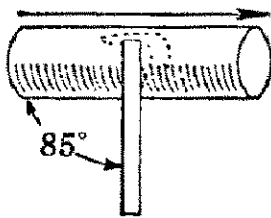

Maintain the file horizontal

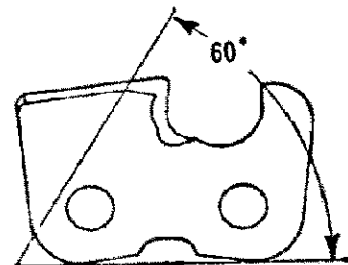

4. Depth gauge

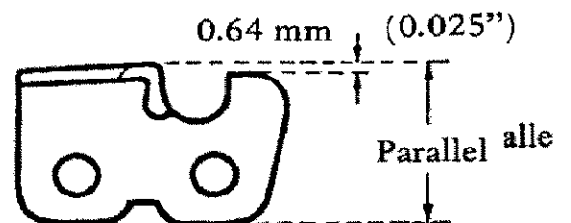
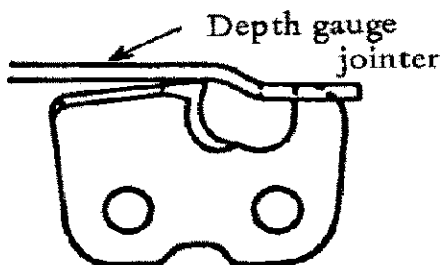

Cleaning the chain

- * When the chain is stained with resin or other foreign material, remove it with petroleum, and apply oil to the chain.

Servicing the bar

- * Keep the bar groove clean.
- * Pay special attention to the oil inlet holes.
- * The bar must be used inside out at regular intervals.

Chain and bar

| Length of bar | Chain: Pitch | 3/8" |
|---------------|-----------------------|----------|
| | Gauge | 0.05" |
| | Number of drive links | |
| 12" (12K50) | 48 | Optional |
| 16" (16K50) | 59 | Standard |
| 20" (20K50) | 69 | Optional |

10. ENGINE MAINTENANCE

Cleaning of air cleanerClean it every day.

- * The air cleaner can be taken off by pulling the rubber placed in the center.
- * Wipe off dust lightly, or rinse the cleaner with gasoline.
- * When rinsed with gasoline, make sure that the cleaner is completely dried before putting it in place.

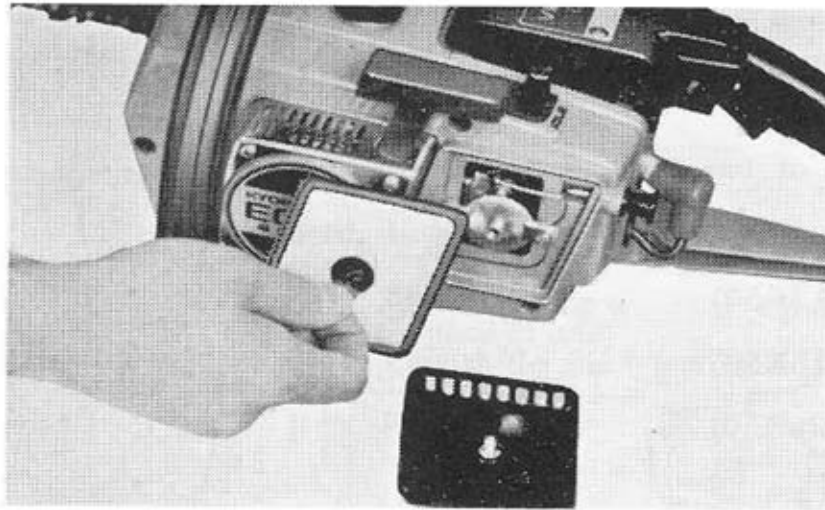

Inspection of screws and nuts Check them every day before using the machine.

- * Check for looseness the screws and nuts of the handles, fan cover and carburetor.

Inspection of the chain and bar Check them every day before using the machine.

- * Set the chain every day.
- * Clean the bar groove.
- * The bar must be used turned inside out once a day.

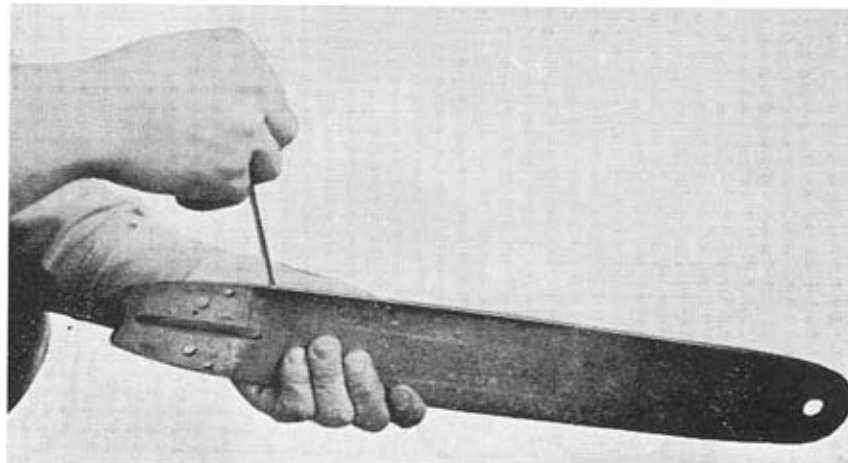

Ignition plug Check it regularly.

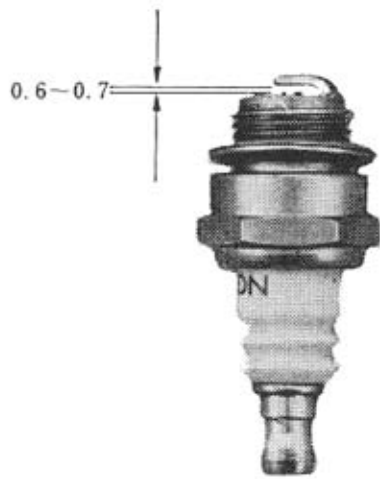

- * The spark gap (a clearance between the electrodes) must be 0.6 – 0.7 mm (0.0236” ~0.0275”).
- * If the gap is too wide or narrow, correct it.
- * When the plug is stained with carbon or other material, take off the plug and clean it.

Fuel tank filter Check it regularly.

- * If the filter is clogged, difficult starting and other engine troubles will result.
- * To clean the filter, remove the fan cover, and take off the filter through the fuel pipe coupling.
- * Rinse the filter with gasoline. If it should be heavily clogged, replace it with new one.
- * Install the filter so that it is placed in the front end of the tank as shown in the right-hand figure.

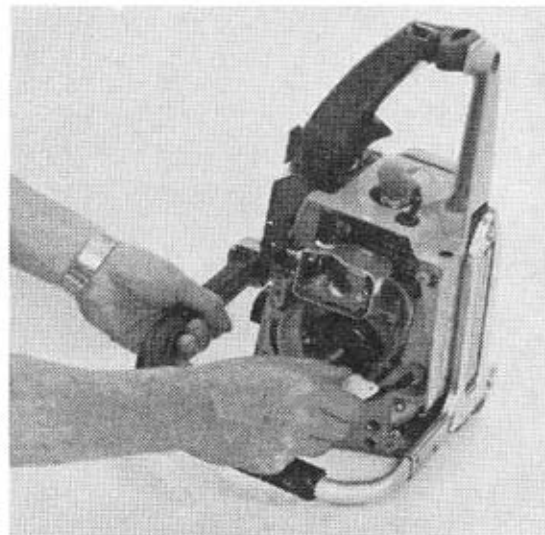

Centrifugal clutch.....Check it regularly.

- * Turn the fastening nut out, and remove the clutch outer ring.
- * Bear in mind that the fastening nut is left-handed.

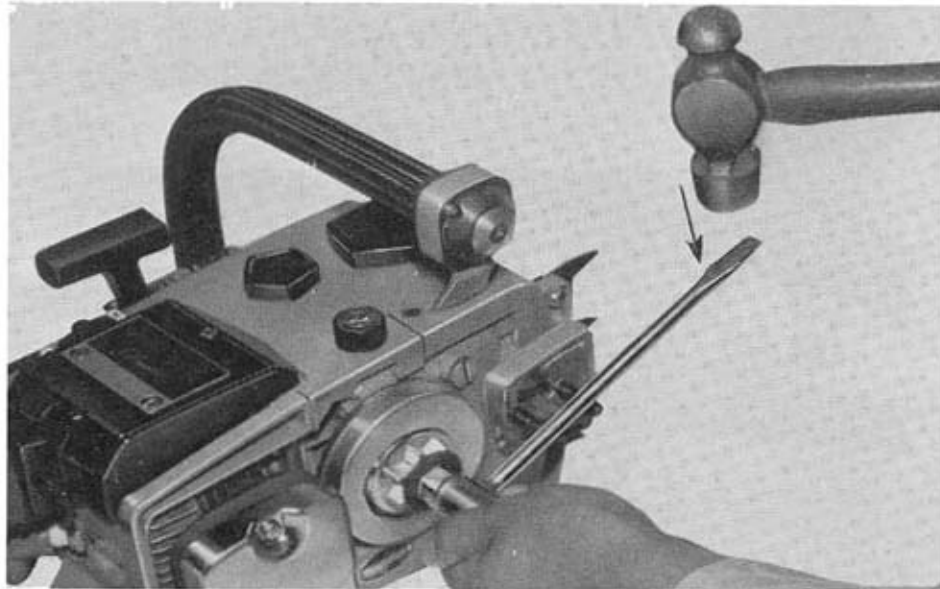

SprocketCheck it regularly.

- * The worn-out sprocket will cause the chain a premature damage.
- * If worn out by 0.25 mm (0.00984") or more, replace it with a new sprocket.

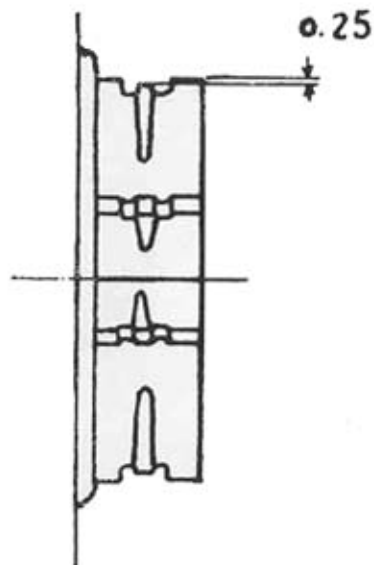

Cylinder fins Check them regularly.

- * If the fins are clogged, the engine cannot be cooled well.
- * Whenever clogged, remove the fan cover to clean the fins.

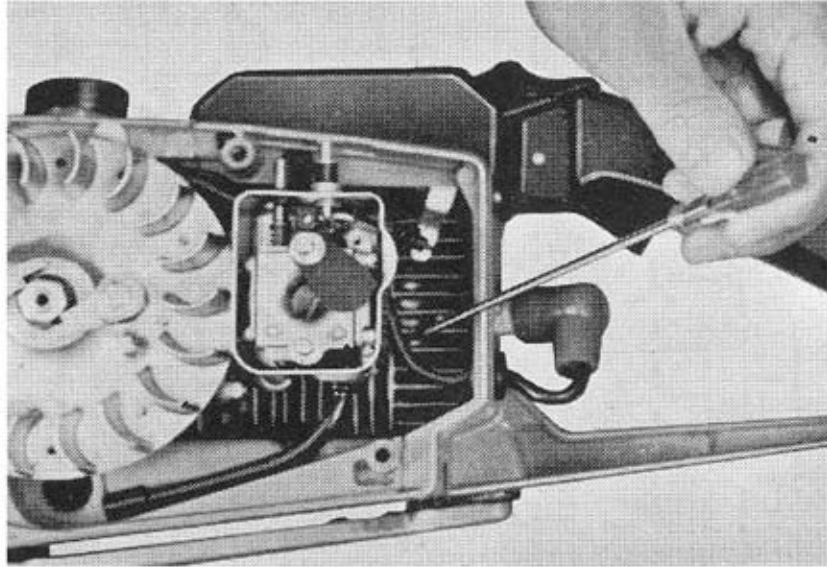

Recoil starter Check it regularly.

- * When the recoil starter does not function normally, dismantle it in the following order. Check it and replace defective parts, if any:
- * Take off the fan cover.
- * Remove the recoil dust filter.
- * Loosen the fastening screw.

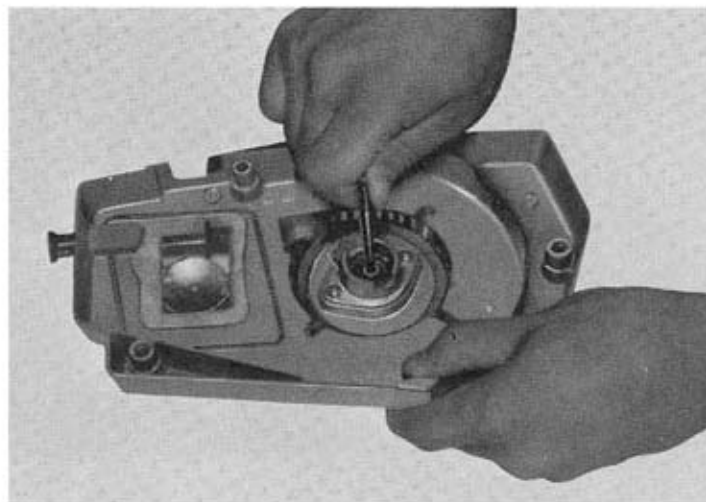

Magneto Check it regularly.

- * Take off the fan cover.
- * To remove the rotor, be sure to use the puller (AT 897501-0). Never try to pull the rotor out by striking it.

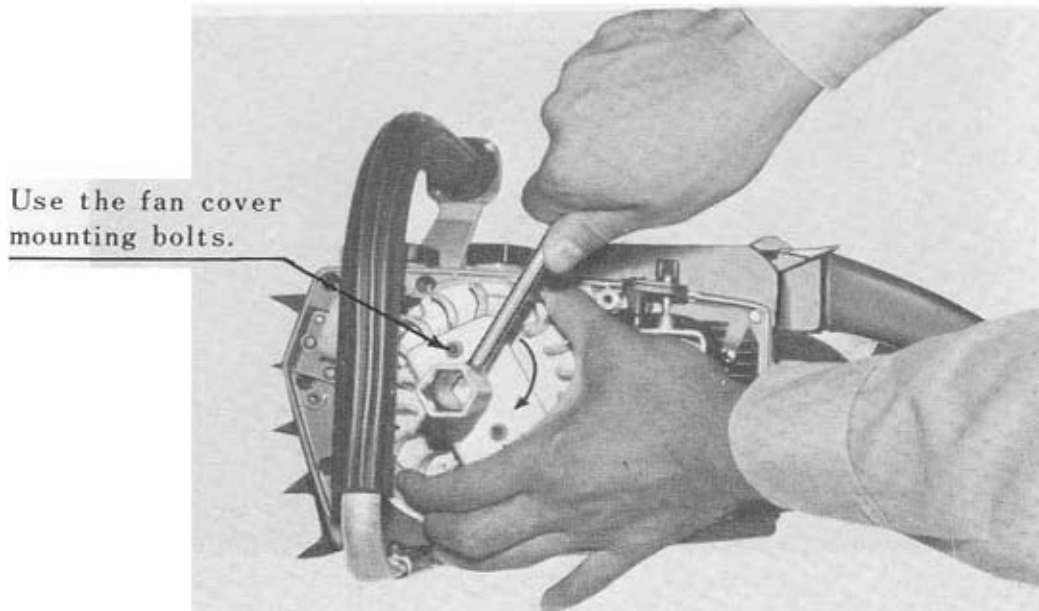

- * Take off the point cover, and make sure that the breaker point gap is 0.35 mm (0.0138").
- * When adjusting the point, be careful not to stain it with oil or any other material.

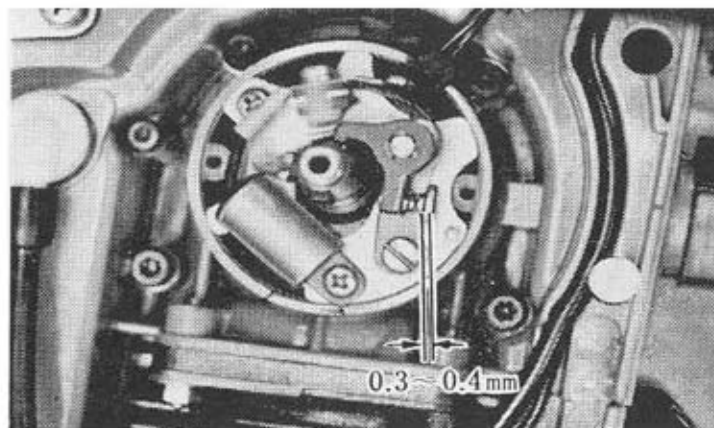

Automatic oiler.....Check it regularly

- * When the chainsaw is shipped from the factory, the automatic oiler is already adjusted to deliver 20 – 25 cc (maximum delivery: 1.225 ~ 1.530 cu.in.) of oil when the engine runs at 6,000 r.p.m.

Note: Turning the adjusting screw counterclockwise decreases the amount of oil delivery. Do not turn the adjusting screw beyond the stopper, because more than 1 complete turn will stop oil delivery.



Oil strainer.....Check it regularly.

- * To remove the oil strainer, pull it lightly after taking off the blank plug placed on the centrifugal clutch.
- * If clogged with sawdust, rinse it with gasoline.
- * When installing the strainer, insert it as shown in the righthand figure. The strainer should be placed under the clutch side.

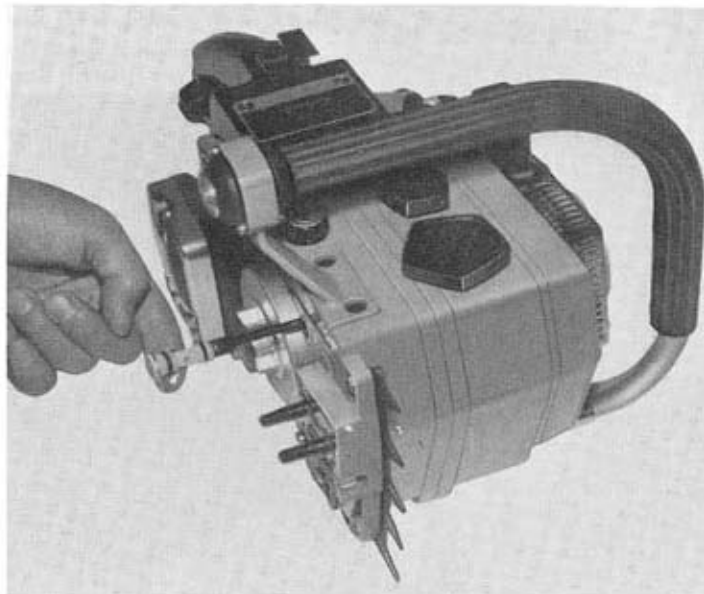

Muffler Check it regularly.

- * If the cylinder exhaust port and the muffler are clogged with carbon, this will cause the engine output to drop and the muffler to throw off sparkles.
- * If clogged, take off the muffler and remove carbon. When cleaning the muffler, be careful not to damage the cylinder.

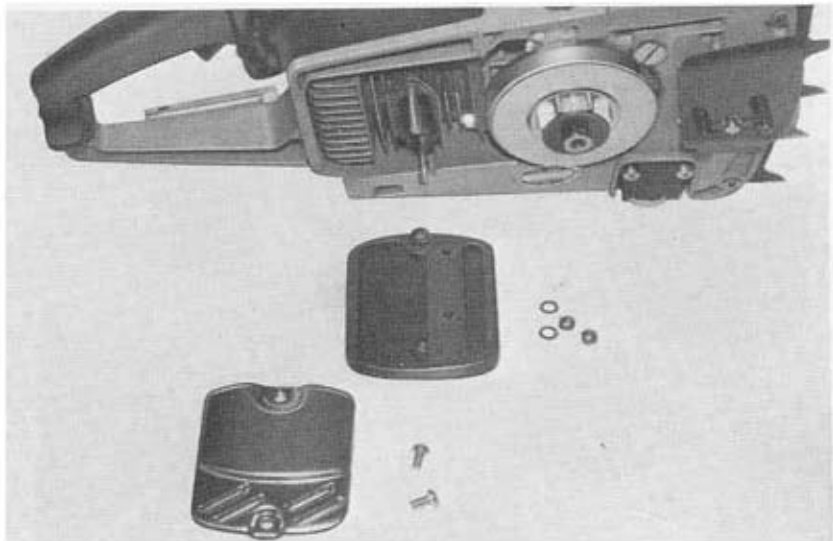

Carburetor

When required to adjust the needle valve, proceed as follows:

- * Turn the adjusting screw clockwise slowly so that the needle valve is in the fully closed position.
- * For high speed running, open the screw 3/4 turn and for low speed, open it one turn.

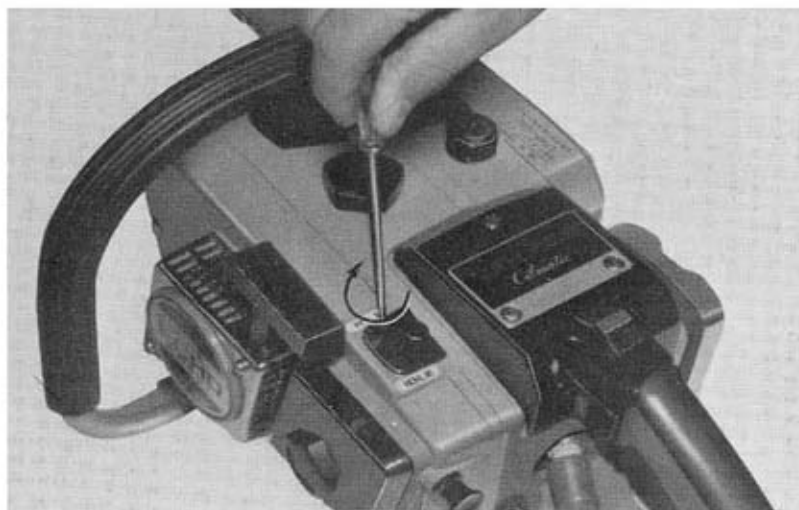

11. TROUBLE SHOOTING

When you have found any trouble with your chainsaw, investigate the cause with the help of the tables below, and disassemble the component in trouble to fix it.

When disassembling, refer to the Part List.

